

DESIGN AND BALANCING CONTROL OF AIT LEG EXOSKELETON-I (ALEX-I)

Narong Aphiratsakun, Kittipat Chirungsarpsook and Manukid Parnichkun
Asian Institute of Technology, P.O.Box 4, Klong Luang, Pathumthanee, 12120, Thailand

Keywords: ALEX-I, Exoskeleton, robot suit, balancing control, mechanical design.

Abstract: This paper is focused on the design of mechanical hardware, controller architectures, and analysis of balancing control at the Asian Institute of Technology Leg EXoskeleton-I (ALEX-I). ALEX-I has 12 DOF (6 DOF for each leg: 3 at the Hip, 1 at the knee and 2 at the ankle), controlled by 12 DC motors. The main objective of the research is to assist patients who suffer from the paraplegia and immobility due to the loss of lower limbs. ALEX-I's parts and assembly are designed on CAD software, SolidWorks, exported to MATLAB simulation environment, and observed using 3D VRML script interpreter to investigate balancing postures of the exoskeleton. The simulation model is proven to be accurate by comparing the resulting kinematics characteristics with the results from Corke's MATLAB Robotics Toolbox (Corke, 1996). PC104 is employed as the main (master) processing unit for calculation of the balanced gait motion corresponding to feedback signals from the force sensors mounted at the two feet plates, whereas ARM7's are used for the low-level (slave) control of the angular position of all joints. The balanced posture set-points (joint trajectories) under the Center of Mass (CM) Criterion are generated in the simulation before testing on the real mechanical parts is implemented to avoid damaging the system.

1 INTRODUCTION

Our society nowadays has many elders and patients that have difficulties in their locomotion. All of these patients need to sit, stand, walk, and perform other activities to fulfil their daily tasks. These people need assistance from either the nursing personnel or assistive devices such as walkers or wheelchairs. Our exoskeleton is intended to work as an intelligent assistive device that would help eliminating the difficulties and risks during the locomotion of the wearer. For this purpose, the exoskeleton has to be able to balance itself, carry the wearer, and walk even if the lower part of the patient is completely paralyzed. In addition to improving the quality of many lives, the developed exoskeleton can also serve as a tool used to imitate and integrate human natural blueprints.

Exoskeleton systems also find their applications in other various fields that draw a lot of interests from many robotics researchers who want to imitate the perfectly-designed and sophisticated biomechanics and human anthropometries. Some of the successful stories are HAL (Kawamoto, Kanbe, Lee and Sankai, 2002 and 2003), BLEEX (Chu, Kazerooni, Zoss, Racine, Huang and Steger, 2005),

and Sarcos (Guizzo and Goldstein, 2005) exoskeletons, which are designed for power enhancing and military missions respectively. HAL-3 was developed by the research team of Tsukuba in Japan. It was designed to help the elders in performing their daily activities such as walking, sitting, and standing. The latest model, HAL-5, is the whole-body suit unit, which is suitable for either the left or the right side paraplegic patient. BLEEX developed by the University of California, Berkeley, and Sarcos developed at Sarcos Research Corp. in Salt Lake City implemented the hydraulic-actuated exoskeletons as they are focusing on the power-enhanced legs for the application of carrying heavy loads in the difficult terrains.

Asian Institute of Technology Leg EXoskeleton-I or known as ALEX-I is developed with the aim to carry with it both the external loads and the pilot (or the wearer). The exoskeleton has to be able to walk on its own. Building up the robot and physically testing it by means of trial-and-error could result in damaging the robot links and fragile electronics devices. Hence, we have to model the exoskeleton robot to conduct the experiments in the both real world and simulated environments. The simulation model of ALEX-I has shown promising results

through the modelling with MATLAB's SimMechanics library. Consequently, precise gait pattern generation can be investigated based on the kinematics information of all moving bodies. This simulation model can serve as the framework for development of the whole-body exoskeleton and all types of biped robots, which will be developed in the future at AIT.

This paper describes the analysis of the architecture layout of the ALEX-I system in both software and mechanical hardware. The mechanical properties and controllers layout of the ALEX-I will be explained in the next 2 sections. The simulation model of the exoskeleton, its the interpretation of experimental result in 3D virtual reality (VR) environment, as well as the example of gait pattern generation of one-step gait motion will be discussed in section 4.

2 MECHANICAL DESIGN

Our previous work (Aphiratsakun and Parnichkun, 2007) reveals the required specification of the 12 actuators through the required torque calculations of all the joints. The range of motion of the joints determined in the previous work is refined to disregard the range that will never be employed in the real physical implementation, and the resulting range of motion of all DOF is shown in Table 1.

The ALEX-I has 12 DOF (6 DOF for each leg: 3 at the Hip, 1 at the knee and 2 at the ankle), controlled by 12 DC motors. Each motor is coupled with a 1:100 gearhead and equipped with a 1024-pulse incremental encoder as a feedback sensor. The Scooter DC motors and Bonfiglioli Gearhead model VF44P63B14 are selected in this work to conform to the required flexibility in the mounting structures, shapes, and weights. Table 2 gives specification of the motors and the gearheads mounted on each joint. Obviously, the torques offered by the gearheads in each joint are in comply with the torque requirements revealed in (Chu, Kazerooni and Zoss, 2005).

Table 1: Range of motion of each joint.

Joint	Axis	Range of rotation (degree)
Hip	X (pitch)	-90<0<90
	Y (yaw)	-35<0<35
	Z (roll)	-15<0<15
Knee	X (pitch)	0<0<90
Ankle	X (pitch)	-45<0<45
	Z (roll)	-20<0<20

Table 2: Specification of the motors coupled with 1:100 gearhead at each joint.

Motors	Joints the motors mounted on	RPM ; Rad/s	Torque [Nm]
250 W	Hip (yaw)	25 ; 2.62	95
350 W	Hip (roll), Ankle (roll)		134
	Hip (pitch), Knee (pitch), Ankle (pitch)		191

The lower limb exoskeleton mechanical parts are designed with a CAD Application, SolidWorks, as shown in Figure 1. The anthropometric considerations and other design parameters are discussed in (Aphiratsakun and Parnichkun, 2007). This CAD assembly can be imported to MATLAB development environment, which will be used to analyze for the balanced gait motion through the simulation model. The simulation model will be revisited in section 4.

With the CAD design, aluminum 5083 with the density of 2657.27 Kg/m³ is mainly used for the frame structure. The front and back views of the fabricated prototype is shown in Figure 2. The weight of the ALEX-I is measured to be 117.5 Kg excluding the weight of the bag pack.

Force sensors or load cells are used to measure the forces exerted by the body. Futek LLB400 load cell, which can measure up to 500 lb (2224 N) of force, is chosen in the implementation. Four of these sensors are placed between two plates of the ALEX-I's feet. INA126 micro power instrumentation amplifier is used as the amplifier for the load cell. The designed layout of the load cell and its amplifier circuit is shown in Figure 3. From the force reading from the load cells, the center of mass (CM) position could be calculated.

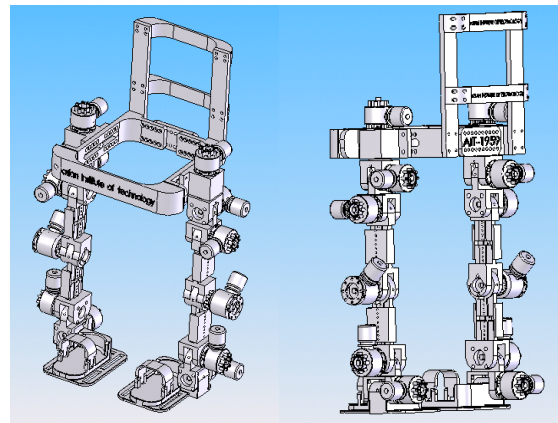

Figure 1: Prototype design of exoskeleton frame (lower part) (a) front view and (b) back view.

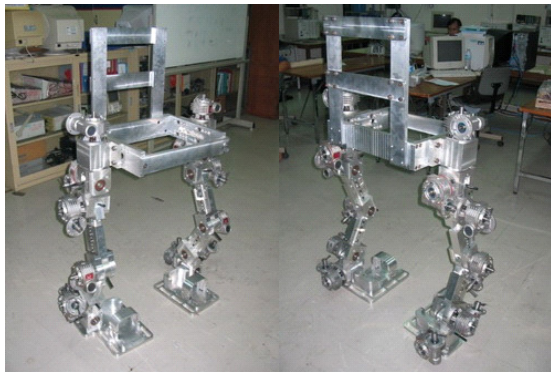

Figure 2: Front and back views of the ALEX-I mechanical frame.

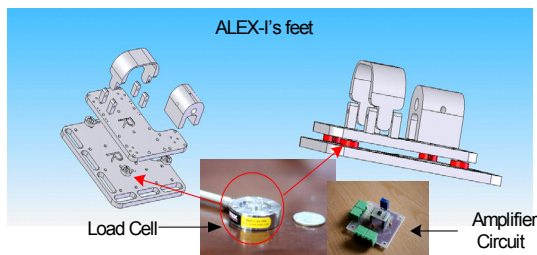

Figure 3: Load cells arrangement.

3 CONTROLLER ARCHITECTURE

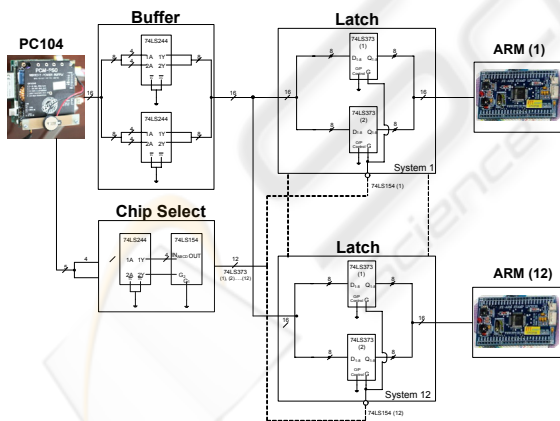

Figure 4: Overview of High and Low level controllers' architecture.

The data of gait analysis from the simulation is used as the input for positional control of the motors, which will eventually make ALEX-I walk in the desired motion. In this work PC104 and ARM7 LPC2138 are used as the high and low level controllers respectively. The overview of the

controllers' layout is shown in Figure 4. The twelve set-points data for the joints' trajectories, which are sent from PC104, are stored in the latching circuit to eliminate the lag time that might be incurred from serial communication. Chip selecting circuit is then used to address each slave-controller with its proper set point. Putting these set-points data in parallel manner allows low-level controller to acquire the data without delay.

3.1 Joint Controller: ARM7 LPC2138 Microcontroller

The joint controller block set is shown in Figure 5. The twelve sets of 16-bits set points command are sent from PC104, which configures the required motion balancing tasks for the whole system, as the input to the low-level close-loops that comprise 2 closed loops (P and PD) for each control block: speed and position loops. 10 Bits, 1024 pulses/rev Koyo TRD-S1024V series incremental encoder is used as a feedback sensor at each joint. LS7366 by LSI, is used to obtain the quadrature A/B of the incremental encoder signal. This IC communicates through SPI with ARM7 processor and increases the quadrature counting up to four times. It increases the resolution of the encoders to 4096 pulses/rev. Axor MicrospeedPlus is chosen as the servo driver and interfaced between ARM7 as shown in Figure 6.

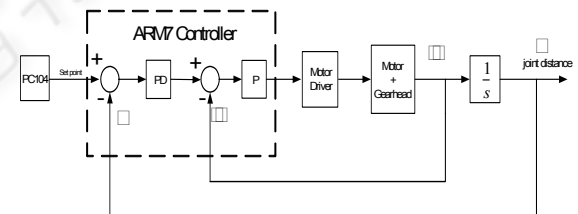

Figure 5: Joint controller.

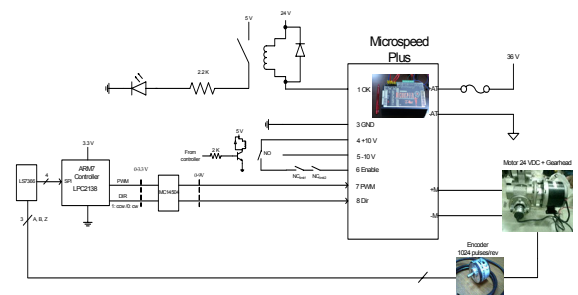

Figure 6: Servo interfacing circuit.

4 SIMULATION MODEL

This section shows the model of ALEX-I in its simulation environment and the gait pattern generation. All links and joints are modelled with their real inertia matrices, links' location of centers of gravity (CG), and location of joints as calculated automatically in Solidworks's mass properties command. Our simulation approach allows the researcher to keep track of all joints' and links' kinematics and dynamics properties very precisely through virtual sensors. Firstly, the ALEX-I SimMechanics model is verified with simple Denavit-Hartenberg (DH) matrix for analysis of manipulator's end-effector to verify the correctness of our simulation model. The balanced gait motion is also performed and shown in latter part of the section.

4.1 Model Verification with Denavit-Hartenberg Matrix and P. I. Corke's MATLAB Robotics Toolbox

To verify the correctness of the simulation modelling, the authors use the DH matrix in describing the 12-DOF ALEX-I assuming that the left ankle is fixed to the ground as if the whole robot is a 12-DOF manipulator with the right ankle being the end-effector. Obviously, the dynamics behavior of the robot with this assumption does not match the real situation. However, the position and velocity obtained from the DH and Jacobian matrix consideration proves our simulation model to be quite accurate in terms of kinematics characteristics. Figure 7 and Table 3 conclude the properties of links as defined by DH (Craig, 2005).

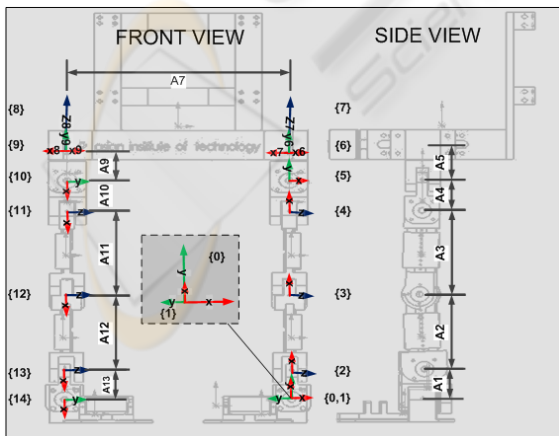

Figure 7: Assignment of coordinate systems in accordance to DH.

Table 3: Links' properties required for the calculation of DH transformation matrixes and Jacobian matrices.

Link	α [degree]	a [m]	θ [degree]	d (m)
1	90	0.1	90	0
2	0	0.26	0	0
3	0	0.28	0	0
4	90	0.11	0	0
5	0	0.12	0	0
6	-90	0	90	0
7	0	0.594	0	0
8	-90	0	0	0
9	0	0.12	-90	0
10	-90	0.11	0	0
11	0	0.28	0	0
12	0	0.26	0	0
13	90	0.1	0	0

Applying the links' properties in Table 3 with the Robotics Toolbox written (Corke, 1996), we obtain another version of stick diagram as shown in Figure 8. The toolbox calculates transformation matrix referred from the end-effector (right ankle) to the world coordinate (left ankle) as similar to that of our simulation model with accuracy of 1 millimeter as shown in the highlighted numerical data. The left circle highlights the transformation matrix resulted from the Corke's procedures whereas the right circle is the data from our developed simulation model.

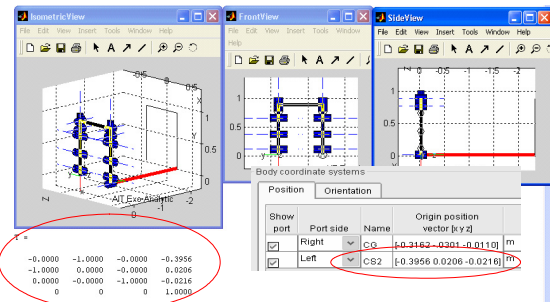

Figure 8: Simulation result from P. I. Corke Robotics Toolbox (Corke, 1996).

4.2 MATLAB Physical Model

The simulation modelling of the 12-DOF ALEX-I has to be started with the transformation of CAD data from the CAD application, SolidWorks, to the physical model format in MATLAB's

SimMechanics. The mating functions and mass properties are automatically translated into the joints and links with precise inertia matrices and joint coordinate systems location as referred from the grounded position. Figure 9 shows the flow of how the precise simulation model can be created from CAD assembly file format. Apparently, this simulation model is very accurate in resembling the real physical exoskeleton as it is created from the exact sizes, mass and inertia properties, and joint locations of the real fabricated links and assembled robot. In the figure, the block diagrams with the signs of the CGs and the signs of 5-DOF represent the robot links and joints as defined in the mating function respectively. Figure 10 shows the imported frontal and lateral views of the ALEX-I model.

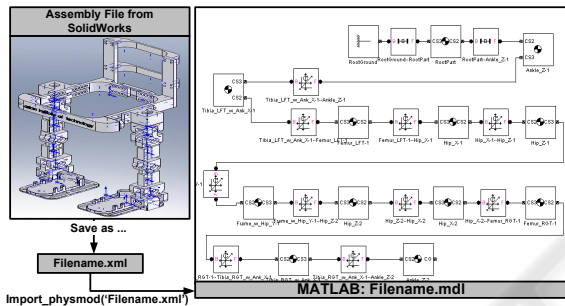

Figure 9: Importing the physical model from SolidWorks assembly file.

4.3 SimMechanics Virtual Sensors

Development of the simulation model on the MATLAB environment offers great advantages since the SimMechanics Library offers virtual sensors that allow monitoring of kinematics and dynamics properties of all moving bodies and joints, including the monitoring of position, velocity, acceleration, angular displacement, angular velocity, angular acceleration, reaction force, and reaction torque. More importantly, the SimMechanics also offers virtual actuators that allow the actuation of both the joints and the bodies by the Source toolbox in the Simulink Library. With the virtual tools offered by SimMechanics Library, the manipulation of all kinematics and dynamics parameters could be done and monitored so as to study the motion behaviour and gait generation of the ALEX-I in virtual environment.

Nevertheless, the numerical data observed from the virtual sensors does not give understandable interpretation unless applied with the graphical visualization. The authors create the graphical interpretation of results both in the forms of 2D

MATLAB graphics and in the 3D Virtual Reality (VR) environment. Figure 11 shows how the motion signals could be used as input to the 3D VR graphics.

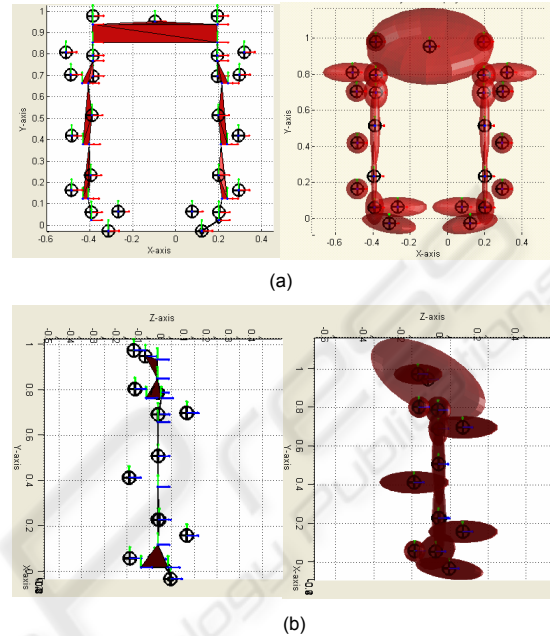

Figure 10: (a) Frontal and (b) Lateral views of transformed diagram.

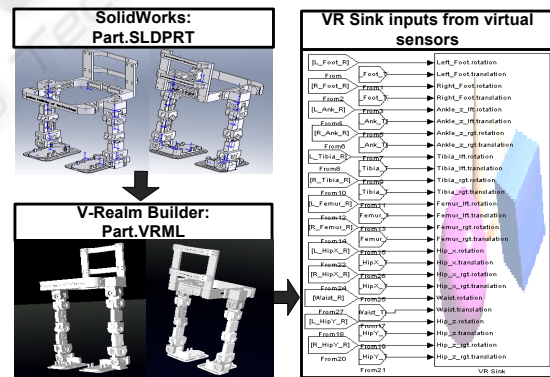

Figure 11: Procedures for the 3D Virtual Reality Graphical Interpretation.

Figure 13 shows the illustrated stick diagram, ellipsoidal mass-represented diagram, and 3D VR animation respectively. The input signals captured from the virtual sensors are fed to each joint for the angular position of all joints. The signals inputted to create the corresponding posture in Figure 13 are shown in Table 4 and Figure 12. θ_{1-12} in the Table 4 are left ankle [z,x], left knee [x], left hip [x,z,y], right hip [y,z,x], right knee [x], right ankle [x,z]

respectively. On the other hand, the input signals observed from virtual scope in Figure 13 are listed as the right ankle [z,x], right knee[x], right hip [x,z], left hip [z,x], left knee [x], and left ankle [x,z] in the order from the top to the bottom.

Table 4: 12 set-points angles.

Angles (degree)					
θ_1	θ_2	θ_3	θ_4	θ_5	θ_6
0.294	36.88	58.95	-66.58	-14.98	0
Angles (degree)					
θ_7	θ_8	θ_9	θ_{10}	θ_{11}	θ_{12}
0	-7.61	-65.15	53.73	-31.47	15.48

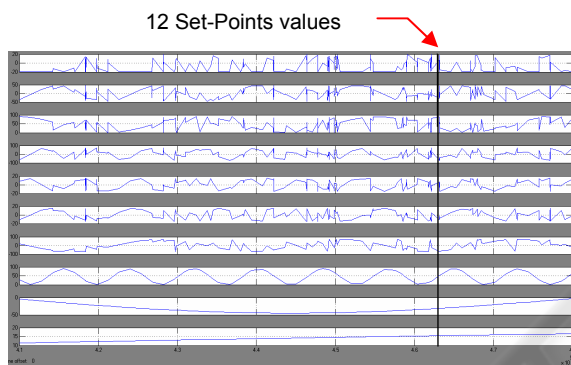

Figure 12: Sampled set-point signals.

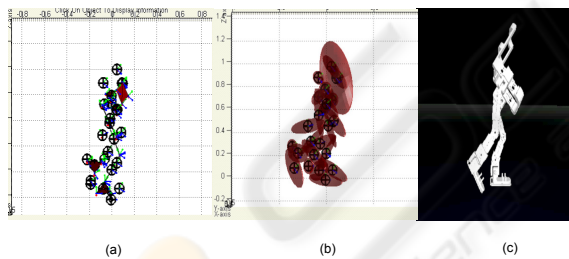

Figure 13: Example of the (a) stick diagram, (b) ellipsoidal mass-represented diagram and (c) 3D Virtual Reality Graphical Interpretation at following set-point.

4.4 One Step Gait Motion

The generation of all geometrically feasible postures of the exoskeleton is done using sine curves to characterize the changes in the joint trajectories by assuming that the left and right feet are supporting and swinging feet respectively. The CM equations as given in (1), (2) and (3) refer to well known zero moment point (ZMP) equations where all accelerations are equal to zero except $g \approx 9.81 \text{ m/s}^2$. With random sampling from all postures (6.1×10^9

postures) while arranging them from time 0 second to 6.1×10^9 seconds, the range of time (searching domain) that returns stable leg-swinging postures could be found from Figure 14 (a) between 4.18×10^9 - 5.91×10^9 seconds. From the sampled experiment, the authors could reduce size of the searching domain from 6.1×10^9 solutions to approximately 2×10^9 solutions. However, from the visual interpretation in VR environment, the postures that result from the solution numbered 4.7×10^9 to 5.91×10^9 show the waist orientation that would be difficult for the wearer of the exoskeleton to move along with the exoskeleton. Therefore, another detail simulation is performed to determine the CM-feasible postures (joint angles) within the searching domain 4.18×10^9 to 4.7×10^9 . The result is shown in Figure 14 (b).

$$z_{ZMP} = \frac{\sum_i m_i (\ddot{y} + g) z_i - \sum_i m_i \ddot{z} y_i - \sum_i I_{ix} \ddot{\theta}_{ix}}{\sum_i m_i (\ddot{y} + g)} \quad (1)$$

$$x_{ZMP} = \frac{\sum_i m_i (\ddot{y} + g) x_i - \sum_i m_i \ddot{x} y_i - \sum_i I_{iz} \ddot{\theta}_{iz}}{\sum_i m_i (\ddot{y} + g)} \quad (2)$$

$$y_{ZMP} = 0 \quad (3)$$

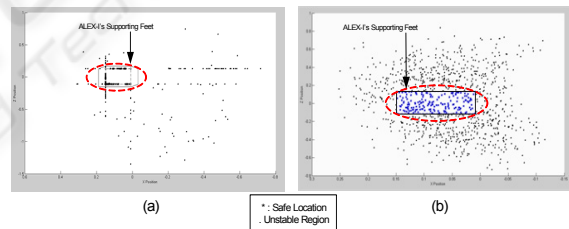

Figure 14: (a) Location of CM sampled over the entire searching domain, (b) Location of CM sampled over the reduced searching domain.

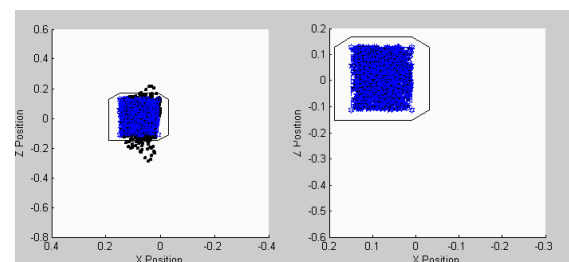

Figure 15: Filter and interpolated feasible posture CM-save joints.

Only the postures (joints angles) that return the balanced gait are saved into the database so that the

interpolation of all feasible joints angles could be interpolated. The filtered postures are again interpolated to obtain very detailed joint trajectories and filtered to get only the balanced CM joints angles. The resulting filtered CM locations are shown Figure 15.

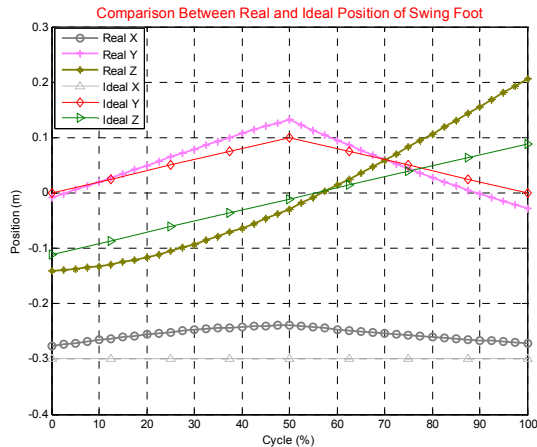

Figure 16: Comparison between ideal and CM-save gait pattern.

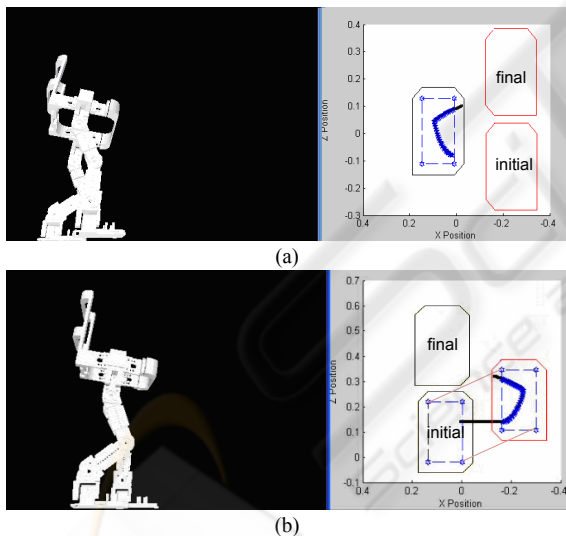

Figure 17: (a) Right-Swing step, (b) Left-Swing step.

With the feasible joint trajectories, the step parameters, which comprise the swinging height, step length, and step time, are obtained. After having all joints angles in the database together with the location of the swing foot and orientation of the ALEX-I from the virtual sensors in the simulation model, the one-step gait pattern is generated from the CM-feasible joint trajectories.

In Figure 16, the ideal walking pattern and balanced CM walking pattern are compared.

Apparently, the obtained step parameters could only be partially achieved since the ALEX-I has to balance itself and could not be in some particular postures. The successful right-swing and left-swing step are shown in the Figure 17 with the outlined initial and final locations of the swung feet.

5 CONCLUSIONS

This paper has revealed the balancing control analysis and design of the architecture layout of the ALEX-I. The ALEX-I was initially controlled to walk in open-loop manner. Position control for each joint is operated with 32-Bits processor ARM7 controller, which senses position feedback from 1024 pulses/rev encoder. PC104 is used as a main controller to control the entire joints controller and to calculate all the set-points for the gait motion of the ALEX-I. The ALEX-I simulation model has been verified with DH matrix Robotics Toolbox and the accurate results are observed. The model has been further integrated to perform gait motion analysis. The motion is captured in the form of 12 set-points observed with virtual sensors offered by SimMechanics library. The CM-feasible balance gait data are filtered and interpolated. One gait cycle has been shown in the simulation and in this study. With the obtained balanced gait motion, the data could be set and calculated by PC104. The future works would emphasize on the ZMP-feasible gait pattern generation, implementation with the real wearer, and disturbance-tolerating control system.

ACKNOWLEDGEMENTS

This research is financially supported by National Electronics and Computer Technology Center (NECTEC), Thailand.

REFERENCES

Aphiratsakun, N., Parnichkun, M., 2007. Preliminary Study and Design of an Exoskeleton. Proceeding of the CRIT 2007, Nakon Pathom, Thailand.
 Chu, A., Kazerooni, H., Zoss, A., 2005. On the Biomimetic Design of the Berkeley Lower Extremity Exoskeleton (BLEEX). Proceeding of the 2005 IEEE International Conference on Robotics and Automation, Barcelona, Spain, pp. 4345-4352.

- Corke, P. I., 1996. *A Robotics Toolbox for MATLAB*, IEEE Robotics and Automation Magazine, no.1, vol.3, pp.24-32.
- Craig, J. J., 2005. *Introduction to Robotics: Mechanics and Control*, Pearson Prentice Hall. 3rd edition.
- Guizzo, E., Goldstein, H., 2005. *The rise of Body Bots*. Spectrum, IEEE.
- Kawamoto, Sankai, Y., 2002. Comfortable Power Assist Control Method for Walking Aid by HAL-3. Proceeding of the 2002 IEEE/SMC International Conference.
- Kawamoto, H., Kanbe, S., Sankai, Y., 2003. Power Assist Method for HAL-3 Estimating Operator's Intention Based on Motion Information. Proceeding of the 2003 IEEE International Workshop on Robot and Human Interactive Communication, California, USA, pp. 67-72.
- Kazerooni, H., Racine, J. L., Huang, L., Steger R., 2005. On the Control of the Berkeley Lower Extremity Exoskeleton (BLEEX). Proceeding of the 2005 IEEE International Conference on Robotics and Automation, Barcelona, Spain, pp. 4353-4360.
- Lee, S., Sankai, Y., 2002. Power Assist Control for Leg with HAL-3 Based on Virtual Torque and Impedance Adjustment. Proceedings of the 2002 IEEE/SMC International Conference.



SciTeP
Science and Technology Publications