

Floating Car Observer – Approaches for Traffic Management Strategies by Analysing Oncoming Vehicles

Franziska Wolf¹, Sebastian Naumann², Christoph Engel³ and René Schönrock⁴

Institut f. Automation und Kommunikation e.V. Magdeburg
Werner-Heisenberg-Str. 1, 39106 Magdeburg, Germany

Abstract. For traffic management systems, the knowledge of urban traffic conditions is essential. The strategy of the Floating Car Observer (FCO) is to collect traffic data via moving traffic sensors. The data of oncoming cars and trucks is detected using a travelling public transport vehicle. Different acquisition strategies are evaluated to establish a low cost application, capable of real time usage. Using the reflection of the infra-red emitter on number plates, traffic data information about the speed and the average density of oncoming traffic is acquired. The properties of the hardware prototype and the implementation of the software strategies are discussed and first research results are presented.

1 Motivation

Today knowledge of the inner-city traffic state is a prerequisite for a functioning traffic management both in private and public transport. Data as speed and traffic density is more and more used for applications on IT systems in public traffic management. These services provide dynamic arrival time prognosis for passengers or sophisticated traffic management strategies for public and private transport. Therefore widespread acquisition methods for spatial and temporal traffic data are desired. The core problem offering such information services is the absolute knowledge of current and future traffic conditions. Traffic processes can be described by several parameters, such as the time headway τ , the traffic flow q and the local speed v_l . The spatially and temporarily complete automatic acquisition of these parameters is desirable, however due to economical and technical reasons it is often not achievable.

1.1 Current Methods of Measuring Traffic Data

Currently the acquisition methods for traffic management systems rely on local detectors such as induction loops, infra-red and video detectors at fixed cross sections ([1] [2]) of a road (see ① in Fig. 1). Unfortunately, these local measurements do not allow the clear determination of traffic states. A second method is the instantaneous observation (see ② in Fig. 1), however except for observation flights (see ④ in Fig. 1) this method has only little practical relevance.

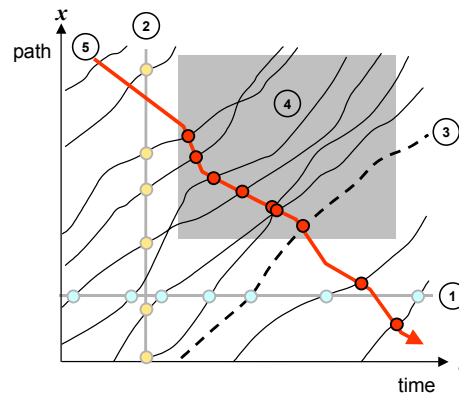

Fig. 1. Path time diagram of traffic course parameters.

An alternative to measuring traffic parameters with stationary devices is the use of Floating Car Data (FCD). A vehicle is used as a mobile traffic sensor for permanently transferring its own traffic data such as speed and position. As shown in ③ in Fig. 1, kinematical parameters of single vehicles such as path x , velocity v and acceleration a can be measured and travel times along road sections can be determined directly. Thus FCD receives a small amount of information because the data only describes the vehicle's own driving course and does not represent traffic conditions in a broad spectrum. If stuck in a traffic hold-up, the usage of a FCD vehicle can not offer information about the length of the hold-up and the estimated time lag for the travel time prognosis. FCD is dependent on the traffic situation which it is going to measure.

1.2 Floating Car Observer

A broader data acquisition method will be the automatic observation of oncoming traffic in order to obtain traffic data. The main idea is that public transport vehicles shall carry devices which can observe traffic conditions on the opposite oncoming lanes. Equipped with low-cost devices, vehicles will be used as Floating Car Observers (FCO) monitoring their road environment and traffic flows along the public transport route network [3]. The advantage of the FCO approach is shown in Fig. 1. The ongoing course ⑤ shows that traffic density $k(x)$ and speed $v(x)$ can be measured directly. The FCO measures the traffic data without being part of the traffic situation. For example the starting points and the length of traffic hold-ups on the oncoming traffic lanes can be observed and used to improve arrival time prognosis of the public transport distributed by various services.

By using this data, traffic diversions can be adapted for present traffic situations.

In the future the traffic data acquired by the FCO module will be sent by GPRS to a traffic management control centre. Additionally the FCO's geographical position, driving direction and speed will be used to generate a continuous overview of the network's current traffic conditions. In the following, the simulation set up to evaluate various potential FCO devices is presented. It will be tested if the device data can be

used for signal processing algorithms for speed and traffic density calculation. The most promising technical strategy will be used for a hardware and software prototype of a FCO.





In this paper, methods of observing vehicle flows in order to gain information about traffic conditions will be outlined. In Section 2 the theoretical background of a system observing oncoming traffic using a Floating Car Observer (FCO) is described. The simulation framework to evaluate different sensors to set up a hardware prototype is outlined. Furthermore it can be shown that the theory of observing oncoming traffic can be realised. In Section 3, a description of the FCO's hardware design is presented. The strategy of using an infra red (IR) emitter combined with a camera to capture specific traffic observing images will be described. The currently developed image processing algorithms to detect traffic vehicles will be described along with the expected results. A conclusion and an outlook at the upcoming steps will conclude the article.

2 FCO Design - Simulation and Evaluation

In preparation for running a computer simulation of the FCO, a model of a public transport vehicle can be equipped with simulated FCO devices such as laser scanner, ultrasonic and video camera systems. These simulated and evaluated devices are already broadly used applications for supporting driver-assistance ([4][5]) and safety applications [6] for example in nighttime situations [7]. However so far they are hardly used for oncoming traffic detection and observation. By altering the configuration of the FCO devices, the different detection rates of the sensors are measured while the vehicle travels through a virtual public transport network, built using a microscopic traffic model of a real existing traffic scenario. Based on empirical values, the simulation evaluates whether the resolution of the devices is appropriate to achieve a detection of the oncoming traffic. For example it was measured to which quantity and distance the FCO sensor types could capture the oncoming vehicles due to the frame rate, detection field and measure values.

In order to equip vehicle fleets of public transport companies with FCO devices, also economical aspects of the systems have to be considered. In this evaluation the sensor types are simulated in a FCO simulation and evaluated as follows:

Table 1. Tested sensor types simulated and evaluated on usability for FCO development.

FCO-sensor type	Function	Field of detection and measure values (Hz)	Range (m)	Disadvantages for FCO usage	Advantages for FCO usage
Light scanner	The sensor sends a directed laser light beam. The reflection is used to calculate distance	 1, 4, 16, 64	20	Discrimination of traffic vehicles hardly achievable Only 1-D resolution	Low acquisition costs
Laser scanner	The laser scanner contains a rotating unit, which sends pulsed laser beams	 19, 38, 75	150	Discrimination of traffic vehicles hardly achievable High acquisition costs	Wide range of 150m High spatial and temporal resolution
Ultrasonic/Radar	The ultrasonic sensor sends sound/ electromagnetic waves where the detection field forms a club. The reflection is used to calculate distances	 10	10 / 50	Discrimination of traffic vehicles hardly achievable Calibration of measuring field required	Low acquisition costs Much experience of this technology in traffic monitoring
Active video camera	The camera system uses pulsed IR lights to recognise retro-reflecting materials, e.g. number plates.	 30 to 60	NN (weather conditions)	Detection range depending on weather conditions	Low acquisition costs Discrimination of traffic vehicles achievable

The evaluation showed that the ultrasonic system has an insufficient usability due to the limited range and specific formed detection field. The laser and ultrasonic sensors may need a second sensor to enable a sufficient range and detection accuracy for traffic data capturing. Due to high acquisition costs, the laser scanner can also not be used for broad traffic monitoring. The camera approach uses positions and sizes of detected objects for data reconstruction. Due to better discrimination of detected objects, a camera system is higher rated than a laser or an ultrasonic system.

The camera based system has been rated to be the most promising system due to its technical properties, low cost and mounting capabilities. The main advantage of

the camera system is its potential for detecting particular objects, cars in this case. However image streams received by a camera system normally are not very significant: but by using an active exposure system the images' quality and therefore the initial position for object recognition can be improved. The usage of such camera systems for traffic monitoring has been proposed, for example for automatic number plate recognition systems [8]. A special system using a similar strategy was originally developed for the recognition and safety improvement of non-motorised, vulnerable road users such as pedestrians or cyclists [9][10]. Equipped with special coated retro-reflectors they could be recognised in IR exposed image streams by object detecting algorithms. Normally cars and trucks are not equipped with such special coated retro-reflectors of this quality, but they provide a slightly retro-reflecting number plate. These number plates have proportions from height to width which are in most countries unique among road signs and other reflecting objects in the road environment. It is essential to identify these reflecting number plates because their shapes will be used for traffic data calculation. By scanning the image streams of the camera, the size and movement of the detected number plates are used for vehicle monitoring and speed reconstruction using geometrical strategies such as intercept theorems.

The following section describes the set up of a hardware and software prototype of a FCO device for visual traffic observation. The usage of embedded infra-red light for detecting number plates of cars in video streams will be dealt with. The set up and configuration of the specified camera system is also described. The current research strategy of the vehicle detecting image processing and speed reconstruction algorithm will be described and implementation methods will be outlined. First results based on images of the simulation are presented.

3 Technical Design of the FCO Prototype

The architecture of the FCO prototype is described in Fig. 2 and contains the following modules:

- CMOS-camera with optical filter for achieving the raw image stream
- Infra-red-emitter for lighting the scenery
- Micro controller

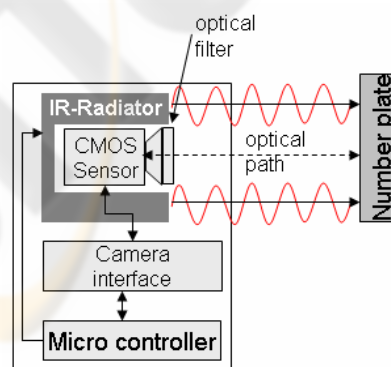

Fig. 2. FCO camera module for recognizing number plates.

The low cost camera module is based on CMOS technology and includes a 12 bit ADC (analogue-to-digital converter). 30 monochrome 12 bit raw images with a resolution of 648*488 pixels can be captured per second. The emitted IR light has a narrow-banded spectrum with a central wavelength of 950 nm. This compact spectrum of the IR emitter enables the usage of a special optical filter in order to improve the quality of the images received by the camera system. As pointed out in Fig. 3 the optical filter reduces the receivable spectrum of the camera to the wavelength from 900 nm to 1000 nm. That reduces the distracting sun light in order to improve the signal-to-noise ratio and therefore makes it easier to detect objects which reflected the IR light..

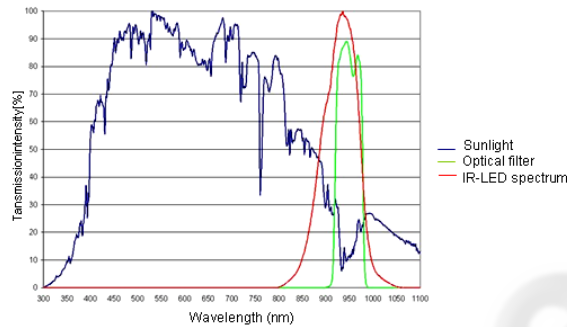



Fig. 3. Spectral sensibility of CMOS sensor with and without optical filter.

The 32 bit ARM microcontroller synchronises the switching and the power control of the IR LED emitter. Provided by the digital camera via a serial I²C interface, the micro controller also runs the image processing and object recognition and tracking algorithms. An overview of the software design and the main modules is described in the following section.

4 Image Processing and Object Recognition Strategies

In this section the basic image processing algorithm will be outlined. The algorithm uses a 12 bit raw data image for input provided by the camera system. During the exposure, the aperture of the camera and the IR emitter are synchronised with each other in order to create video images with good detectable objects. The on and off switching of the infra-red emitter can be synchronised to the camera in two different ways, shown in Table 2.

Table 2. Two methods of IR embedded image processing.

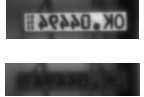
	Function	Image	Advantages	Disadvantages
Stripe Algorithm	Every second line of a frame is exposed by the infra-red emitter. Generates bright and dark striped pattern for reflecting objects.		Small amount of data	Lower resolution. Distortion of reflections possible.
Two Frame Algorithm	Every second frame is exposed by the infra-red emitter. Generates bright patterns for reflecting objects		Allows a more accurate calculation	High amount of data

Both algorithms are able to achieve specified video frames. The *Stripe Algorithm* allows a fast processing rate, but a lack of exposure can lead to an insufficient object recognition. The *Two Frame Algorithm* allows a more accurate calculation but needs double the amount of data of the first strategy. It has to be researched which strategy is the best for the following object recognition algorithm shown by the application flow in Fig. 4. The process flow starts with the exposure of traffic scenery to create raw data images to enable clearly visible highlighted areas based on IR reflection on vehicle number plates. These rectangular areas have to be detected by the algorithm in each frame. The next step is to track each of these rectangles from frame to frame. This is done using position and size of the rectangles as similarity measures. Traffic data of the detected cars can be computed using the number plates' course through the images. It has been analysed for the image processing algorithm done by the micro controller, whether the usage of Java or the specified Open CV libraries for C++ can accomplish these tasks best. These steps are marked red in the application flow.

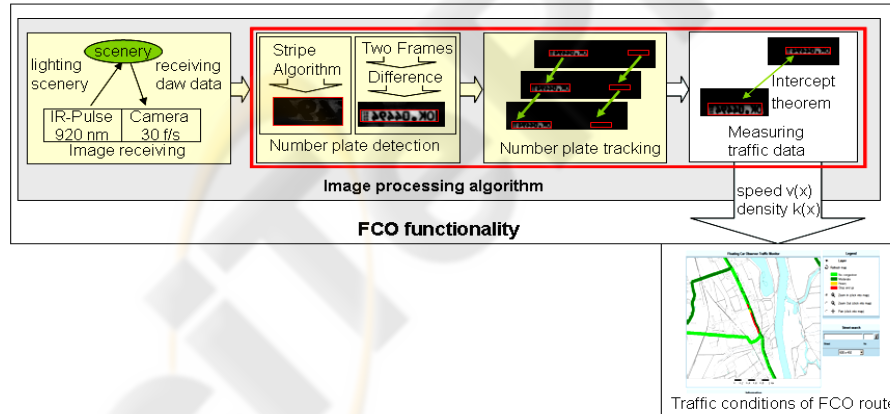
**Fig. 4.** Vehicle detection and data reconstruction of FCO.

The following pseudo code presents the steps of the rectangle detection in the raw data images, the number plate tracking and the measurement of the traffic data. For the following FCO algorithm in pseudo code, the following variables are to be mentioned:

- lrf, lrc – list of the rectangles found in the current frame, the rectangles' course
- h(NPfn), h(NPfl) – height of the rectangle in the first/ last captured frame
- h(NPR) – real height of a number plate
- fd – focal distance of the camera system used
- hit - threshold condition fulfilled

FCO algorithm describing the number plate detection, tracking and traffic data calculation.

```

FCO ALGORITHM
for (every recorded frame) do
{
  while (the lower right corner of the frame is not reached)
  {
    browse image;
    if (hit)
    {
      create rectangle with a dimension of 0;
      while (new hit in the area of the rectangle)
      {
        rectangle increased until includes new hit
      }
    }
    if (r NOT (ratio 52:11 OR 34:20))
    {
      remove r;
    }
  }
  store all remaining rectangles of frame as list lrf;
  for (the last added rectangle (rlast in lrc)) do
  {
    for (every rectangle (r in lrf)) do
    {
      if ((dist(center of rlast and r)) < thresholddist)
      {
        add r to lrc;
        remove r from lrf;
      }
    }
  }
  for (every rectangle remaining in lrf) do
  {
    create new list lrci with rectangle as first element;
  }
  for (every list lrci without a new rectangle added,
      rectangle course is assumed as finished) do
  {
    s1 = h(NPfl) / h(NPR) * fd;
    sn = h(NPfn) / h(NPR) * fd;
    t = tn - t1;
    s = sn - s1;
    v = s/t;
    print out v;
    delete lrci;
  }
}

```

In order to track the patterns in each image, previous knowledge about the movement of the number plates has to be used. Because of the high frame rate of up to 30

frames/sec, the position of a rectangle in one frame can be assumed similar in the next frame. While tracking the rectangles of the video frames, the change of size and position of the rectangles from frame to frame is used to reconstruct the speed of the detected vehicles using intercept theorems.

Recent test results show that the algorithm works well for simulated streams and encouraging results for first captured images of the FCO hardware prototype could be achieved.

Before the FCO module can be integrated into a public transport vehicle, broad field tests will be necessary. For this a test vehicle is equipped with the required measuring and computing technology. The equipped test vehicle will be used for broad test scenarios covering data acquisition in varying seasonal weather situations at selected places.

5 Conclusions and Future Prospects

This paper offers a new approach to acquire data of actual traffic situations using a Floating Car Observer (FCO). The FCO captures data of the traffic situation of oncoming vehicles, such as positions and lengths of traffic hold-ups. The captured data will be used to enhance travel time prognosis for public traffic management systems. A simulation framework was used to evaluate different traffic observing devices (laser, ultrasonic, camera) in order to set up a traffic monitoring FCO prototype. The evaluation derives from detection rates, but also from real time capability of the computing process and economical aspects of the devices. The system chosen to set up a FCO prototype comprises of video processing and infra-red emitting modules. The reflection of the infra-red beams on vehicles' number plates shall be used to gain information about speed and average density of the oncoming traffic. The algorithm presented detects the highlighted patterns of reflection and tracks them. Using intercept theorems, the courses of the number plate reflections are used to extract traffic data such as traffic density and speed. The algorithm is currently implemented and tested on various platforms. In future this traffic information will improve management systems of the public transport to inform passengers about broad traffic situations and estimated arrival times.

At present the set up of the FCO prototype is used for image capturing of traffic scenarios. These real images have been used together with synthetic simulation images to develop the presented algorithm. In this respect currently different platforms and system frameworks are tested for the implementation of the algorithm. The software has to be evaluated on different traffic road situations, seasonal and weather conditions. Analysis of the detection rates under different weather and seasonal conditions will reveal their implementable capacities and limits. Additionally it will be examined as to which traffic condition the system can be best applied to and which kind of traffic data is the most significant for traffic management systems. Consolidating the most effective data into global strategies will be the next step towards advanced public and private traffic management systems.

References

1. Minakata, T. Taniguchi, Y. Shiranaga, H. Nishihara, T.: Development of Far Infra-red Vehicle Sensor System, Sei Technical Review – English edition, ISSU 58, Sumitomo electric industries LTD, Japan (2004) 23-27
2. Sumiya, N.; Fujihira, K.; Kamijo, S.: Incident detection system by sensor fusion network employing image sensors and supersonic wave, Proceedings of the Intelligent Transportation Systems Conference, 06. IEEE Volume, (2006), 1066 - 1071
3. Hoyer, R.; Czogalla, O; Naumann, S.: Improvement of real time passenger information by floating car observers, Proceedings of the 13th World Congress on Intelligent Transport Systems, London (2006)
4. Nagata Akihito, Ozawa Shinji, Yanagawa Hirohiko, “Approach Vehicle Detection from the Rear Side Using Fish-eye Camera”, Papers of Technical Meeting on Information Processing, IEE Japan, Vol. IP-07; No. 1-13; (2007), 65-70
5. Wannes van der Mark, Dariu M. Gavrilă, “Real-time dense stereo for intelligent vehicles”, Intelligent Transportation Systems, IEEE Transactions on Publication Date: March 2006, Vol 7, Issue 1, 38-50
6. Lages, Dr. U.: Laser Sensor Technologies for Preventive Safety Functions. IBEO Publication 12th International Symposium ATA EL 2004
7. Graf, T.; Seifert, K.; Meinecke, M.; Schmidt, R.: Advanced Night Vision Systems Concepts, Conference Title 12th World Congress on Intelligent Transport Systems, 12th World Congress on Intelligent Transport Systems, San Francisco, 06. -11.11. 2005, Proceedings
8. Sulehria, H.; Zhang, Y.; Irfan, D: Mathematical Morphology Methodology for Extraction of Vehicle Number Plates, International Journal of Computers, Issue 3, Volume 1, 2007
9. Hoyer, R.; Schönrock, R.: Approach to the Recognition of non-motorised Road Users, Proceedings of the 8th World Congress on Intelligent Transport, Sydney (2001)
10. Hoyer, R.; Herrmann, A.; Schönrock, R: Modelling of vehicle actuated traffic lights. In: Schulze, Th. Et al.: (Hrsg.): Simulation und Visualisierung 2004. Society for Modeling and Simulation International SCS-European Publishing House, Erlangen, San Diego, 2004, S. 359 – 369; ISBN 3-936150-30-3.