

# SELECTION OF DIFFERENT PATHS FOR DOUBLY NONHOLONOMIC MOBILE MANIPULATORS

Alicja Mazur and Elżbieta Roszkowska

*Institute of Computer Engineering, Control and Robotics,*

*Wrocław University of Technology, ul. Janiszewskiego 11/17, 50-372 Wrocław, Poland*

**Keywords:** Mobile manipulator, Nonholonomic constraints, Path following, Frenet parametrization.

**Abstract:** This paper describes a problem of designing control laws preserving a motion along desired path for doubly nonholonomic mobile manipulators. The doubly nonholonomic mobile manipulator is composed of a mobile platform moving without slipping effect between wheels and the surface (i.e. nonholonomic platform) and an onboard manipulator equipped with special nonholonomic gears, designed by Nakamura, Chung and Sjørdalen. A task for any nonholonomic subsystem (i.e. nonholonomic platform or nonholonomic manipulator) is to follow a desired path – some geometric curve parameterized by curvilinear distance from selected point. A description of the nonholonomic subsystem relative to the desired path using so-called Frenet parametrization is a basis for formulating the path following problem and designing a kinematic control algorithm.

## 1 INTRODUCTION

A mobile manipulator is defined as a robotic system which consists of a mobile platform, equipped with non-deformable wheels, and a manipulator mounted on the platform.

The problem with a path definition for the end-effector of the mobile manipulator is that behavior of the subsystems is unpredictable, because the same path defined in global coordinates can be executed by separate subsystems or by both of them. Sometimes, it is important to move the platform and simultaneously unload a payload: such a task is defined relative to the base of the manipulator mounted on the platform; definition relative to the end-effector is ill-conditioned. In such situation the decomposition of the task into tasks defined separately for both subsystems is more natural and convenient (Mazur and Szakiel, 2009).

In the paper we assume that a desired task can be decomposed into two separate subtasks defined for each subsystem independently: the end-effector has to follow a desired geometric path described relative to the base of manipulator (i.e. relative to the platform) and the task of the platform is to follow a desired curve lying on a plane. Such a formulation of the task makes possible successive unloading of payload transported by the mobile manipulator during the control process.

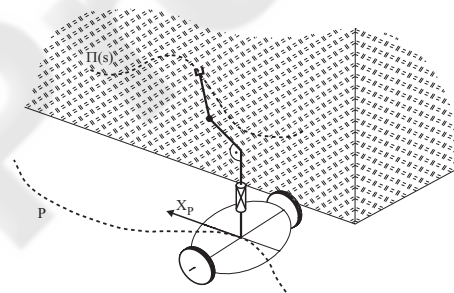

Figure 1: Decomposition of a task for doubly nonholonomic mobile manipulator:  $P(s)$  – desired path for a nonholonomic platform,  $\Pi(s)$  – desired path for a nonholonomic manipulator.

Taking into account the type of components mobility of mobile manipulators, there are 4 possible configurations: type  $(h, h)$  – both the platform and the manipulator holonomic, type  $(h, nh)$  – a holonomic platform with a nonholonomic manipulator, type  $(nh, h)$  – a nonholonomic platform with a holonomic manipulator, and finally type  $(nh, nh)$  – both the platform and the manipulator nonholonomic. The notion *doubly nonholonomic* manipulator was introduced in (Tchoń et al., 2004) for the type  $(nh, nh)$ .

Mazur A. and Roszkowska E. (2010).

SELECTION OF DIFFERENT PATHS FOR DOUBLY NONHOLONOMIC MOBILE MANIPULATORS.

In *Proceedings of the 7th International Conference on Informatics in Control, Automation and Robotics*, pages 15-21

Copyright © SciTePress

## 2 MATHEMATICAL MODELS OF DOUBLY NONHOLONOMIC MOBILE MANIPULATOR

In this paper we restrict our considerations to mobile manipulators of  $(nh, nh)$  type, i.e. to doubly nonholonomic objects. We will only discuss the constraints occurring in the motion of both subsystems. Nonholonomic constraints appearing in the motion of mechanical systems come from different sources. Very often they come from an assumption that a motion of the system can be treated as pure rolling of components, without slippage effect. We have taken such assumption in description of constrained motion of the considered mobile manipulator.

### 2.1 Nonholonomic Constraints for Wheeled Mobile Platform

Motion of the mobile platform can be described by generalized coordinates  $q_m \in R^n$  and generalized velocities  $\dot{q}_m \in R^n$ . The wheeled mobile platform should move without slippage of its wheels. It is equivalent to an assumption that the momentary velocity at the contact point between each wheel and the motion plane is equal to zero. This assumption implies the existence of  $l$  ( $l < n$ ) independent nonholonomic constraints expressed in Pfaffian form

$$A(q_m)\dot{q}_m = 0, \quad (1)$$

where  $A(q_m)$  is a full rank matrix of  $(l \times n)$  size. Since due to (1) the platform velocity is in a null space of  $A(q_m)$ , it is always possible to find a vector of special auxiliary velocities  $\eta \in R^m$ ,  $m = n - l$ , such that

$$\dot{q}_m = G(q_m)\eta, \quad (2)$$

where  $G$  is an  $n \times m$  full rank matrix satisfying the relationship  $AG = 0$ . We will call the equation (2) the kinematics of the nonholonomic mobile platform.

### 2.2 Nonholonomic Constraints for Manipulator

A rigid manipulator can be a holonomic or a nonholonomic system – it depends on construction of its drives. In (Nakamura et al., 2001; Chung, 2004) the authors have presented a new nonholonomic mechanical gear, which could transmit velocities from the inputs to many passive joints, see Figures 2-3. The prototype of 4-link manipulator with such gears has been developed in last 1990th years. Similar nonholonomic 3-link manipulator is under construction at Poznań University of Technology, Poland (Michałek

and Kozłowski, 2004). The nonholonomic constraints in the gear appear by assumption on rolling contact without slippage between balls of gear and wheels in the robot joints.

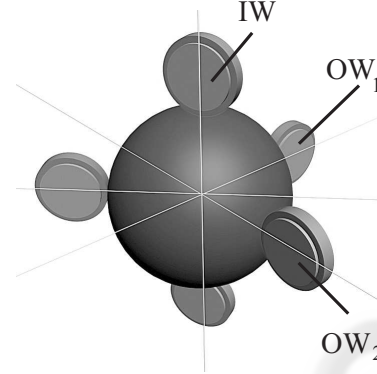

Figure 2: Schematic of the nonholonomic gear.

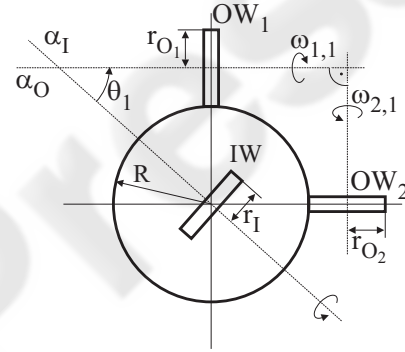

Figure 3: Nonholonomic gear seen from above.

The basic components of the gear presented in Figure 2 are a ball and three wheels – an input wheel IW and two output wheels OW<sub>1</sub> and OW<sub>2</sub>. The velocity constraints of the ball are only due to point contact with the wheels. The input wheel IW is mounted in the first joint, the output wheels are mounted in the next joint. The wheel IW rotates around the fixed axis  $\alpha_I$  with an angular velocity  $u_2$ , which plays the role of a control input. The rotating input wheel IW makes the ball rotate. The wheel OW<sub>1</sub> rotates around an axis  $\alpha_O$ , which makes with the axis of the input wheel a joint angle  $\theta_1$ . The angular velocity  $\dot{\theta}_1 = u_1$  is the second control input for the manipulator with nonholonomic gears.

Nonholonomic constraints (the kinematics) of  $n$ -pendulum have the form

$$\dot{\theta}_1 = u_1, \quad (3)$$

$$\dot{\theta}_i = a_i \sin \theta_{i-1} \prod_{j=1}^{i-2} \cos \theta_j u_2, \quad i \in \{2, \dots, n\}, \quad (4)$$

with positive coefficients  $a_i$  depending on gear ratios. Hypothetical manipulator with 3 links and nonholonomic gears has been presented in Figure 4.

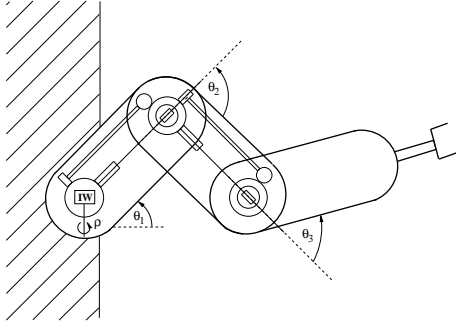

Figure 4: Schematic of 3-link nonholonomic manipulator.

It is worth to emphasize that only two inputs  $u_1$  and  $u_2$  are able to control many joints of manipulator equipped with gears designed by Nakamura, Chung and Sjørdalen.

### 3 DESCRIPTION OF NONHOLONOMIC SYSTEM RELATIVE TO A GIVEN PATH

For nonholonomic systems whose workspace is planar, it is possible to describe state variables relative to global inertial frame as well as to a given path (Mazur, 2004), see Figure 5.

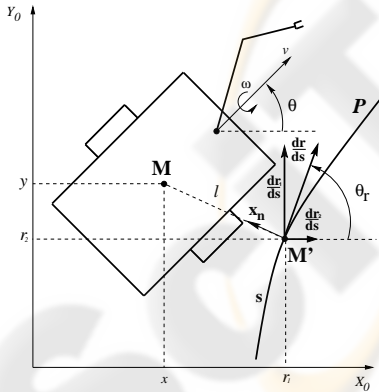

Figure 5: Illustration of path following problem for the non-holonomic platform.

The path  $P$  is characterized by a curvature  $c(s)$ , which is the inversion of the radius of the circle tangent to the path at a point characterized by the parameter  $s$ . Consider a moving point  $M$  and the associated Frenet frame defined on the curve  $P$  by the normal

and tangent unit vectors  $x_n$  and  $\frac{dr}{ds}$ . The point  $M$  is the mass center of a mobile platform and  $M'$  is the orthogonal projection of the point  $M$  on the path  $P$ .

The point  $M'$  exists and is uniquely defined if the following conditions are satisfied (Fradkov et al., 1999):

- The curvature  $c(s)$  is not bigger than  $1/r_{min} > 0$ .
- If the distance between the path  $P$  and the point  $M$  is smaller than  $r_{min}$ , there is a unique point on  $P$  denoted by  $M'$ .

The coordinates of the point  $M$  relative to the Frenet frame are  $(0, l)$  and relative to the basic frame  $X_0Y_0$  are equal to  $(x, y)$ , where  $l$  is the distance between  $M$  and  $M'$ . A curvilinear abscissa of  $M'$  is equal to  $s$ , where  $s$  is a distance along the path from some arbitrarily chosen point.

If we want to express the position of the point  $M$  not in coordinates  $(x, y)$  relative to inertial frame, but relative to the given path  $P$ , we should use some geometric relationships, (Mazur, 2004),

$$\dot{l} = (-\sin \theta_r \quad \cos \theta_r) \begin{pmatrix} \dot{x} \\ \dot{y} \end{pmatrix}, \quad (5)$$

$$\dot{s} = \frac{(\cos \theta_r \quad \sin \theta_r)}{1 - c(s)l} \begin{pmatrix} \dot{x} \\ \dot{y} \end{pmatrix}, \quad (6)$$

where  $\dot{x}$  and  $\dot{y}$  are defined by nonholonomic constraints for the system (wheeled mobile platform or nonholonomic manipulator) and  $\theta_r$  is a desired orientation at the point  $M'$  on the path.

#### 3.1 Path Following with Desired Orientation

##### 3.1.1 Nonholonomic Mobile Platform

Posture of the mobile platform is defined not only by the position of the mass center, but by the orientation, too. For this reason, it is necessary to define the orientation tracking error equal to  $\tilde{\theta} = \theta - \theta_r$ . Moreover, at the point  $M'$  the desired orientation of the platform fulfills a condition, (Samson, 1995),

$$\dot{\tilde{\theta}}_r = c(s)\dot{s}. \quad (7)$$

Then the coordinates

$$\xi = (l, \tilde{\theta}, s)^T \quad (8)$$

i.e. the Frenet coordinates  $(l, s)$  and orientation tracking error  $\tilde{\theta}$ , constitute path following errors for non-holonomic mobile platform. It is worth to mention that Frenet parametrization is valid only locally, near the desired path.

As we mentioned earlier, out of Frenet coordinates it is enough to consider only  $l$  and  $\tilde{\theta}$ . Due to expressions (5) and (7), Frenet variables for mobile platform of (2,0) class described by nonholonomic constraints

$$\begin{pmatrix} \dot{x} \\ \dot{y} \\ \dot{\theta} \end{pmatrix} = \begin{bmatrix} \cos\theta & 0 \\ \sin\theta & 0 \\ 0 & 1 \end{bmatrix} \begin{pmatrix} v \\ \omega \end{pmatrix} = G(q_m)\eta \quad (9)$$

can be defined as follows

$$\begin{cases} \dot{l} = v \sin \tilde{\theta}, \\ \dot{\tilde{\theta}} = \dot{\theta} - \dot{\theta}_r = \omega - v \cos \tilde{\theta} \frac{c(s)}{1-c(s)l} = w, \end{cases} \quad (10)$$

where  $w$  is a new control input for the second equation.

For the system (10) we can use many control laws, e.g. algorithm introduced in (Samson and Ait-Abderrahim, 1991),

$$\begin{cases} v = \text{const} \\ w = -k_2 l v \frac{\sin \tilde{\theta}}{\tilde{\theta}} - k_3 \tilde{\theta}, \quad k_2, k_3 > 0, \end{cases} \quad (11)$$

which is asymptotically stable. It can be shown using the following Lyapunov-like function

$$V(l, \tilde{\theta}) = k_2 \frac{l^2}{2} + \frac{\tilde{\theta}^2}{2} \quad (12)$$

and Barbalat lemma.

Path following with a desired orientation is very important for mobile systems, especially for mobile manipulators. It comes from the fact that it would be impossible to unload a payload if the platform had wrong orientation, i.e. it would be in a right place but back-oriented.

### 3.1.2 Nonholonomic Manipulator

For a nonholonomic manipulator it is possible to follow along the desired path with prescribed orientation. However, this issue has a drawback. Namely, nonholonomic manipulator has only two control inputs, therefore it is impossible to have the mentioned three parameters ( $l, s, \theta$ ) under control. In such a case many authors decide to regulate only two tracking errors ( $l, \tilde{\theta}$ ) to zero and they omit the differential equation for  $\dot{s}$ , because it does not matter at which point  $s$  of the desired path the mobile platform enters the desired curve  $P(s)$ , see (Fradkov et al., 1999) for details. Such a case of the path following problem we will call the asymptotic path following.

The Frenet parametrization can be evoked once again in the problem of path following for the planar manipulator with nonholonomic gears moving on the XZ surface. The role of the point M in Figure 5 plays a point at the end of a gripper. The orientation

of the end-effector  $\theta_m$  is an rotation angle of the frame associated with the gripper around  $-Y_b$  axis, which is located in the base of the manipulator. It means that the orientation of the end-effector in the planar nonholonomic  $n$ -pendulum is then equal to

$$\theta_m = \sum_{i=1}^n \theta_i.$$

In the considered planar nonholonomic manipulator lying in XZ-plane, relationships between velocity of the working point M expressed in Cartesian and curvilinear coordinates have the form

$$\dot{l}_m = (-\sin \theta_{rm} \quad \cos \theta_{rm}) \begin{pmatrix} \dot{x} \\ \dot{z} \end{pmatrix}, \quad (13)$$

$$\dot{s} = \frac{(\cos \theta_{rm} \quad \sin \theta_{rm})}{1 - c(s)l_m} \begin{pmatrix} \dot{x} \\ \dot{z} \end{pmatrix}, \quad (14)$$

where  $l_m$  denotes distance between the point M and the path  $\Pi(s)$ , and  $\theta_{rm}$  is the orientation of the Frenet frame in the point M'. Subscripts were introduced to distinguish Frenet variables for both subsystems of the ( $nh, nh$ ) mobile manipulator.

Coordinates of the end-effector in the  $n$ -pendulum relative to its base are equal to

$$\begin{cases} x = \sum_{i=1}^n l_i \cos \left( \sum_{j=1}^i \theta_j \right), \\ z = \sum_{i=1}^n l_i \sin \left( \sum_{j=1}^i \theta_j \right). \end{cases} \quad (15)$$

Substituting time derivatives of variables (15), we obtain the following equations

$$\dot{l}_m = \sum_{i=1}^n \cos \left( \theta_{rm} - \sum_{j=1}^i \theta_j \right) l_i \sum_{k=1}^i \dot{\theta}_k, \quad (16)$$

$$\begin{aligned} \dot{\tilde{\theta}}_m &= \dot{\theta}_m - c(s)\dot{s} = \sum_{i=1}^n \dot{\theta}_i - \frac{c(s)}{1 - c(s)l_m} \cdot \\ &\cdot \sum_{i=1}^n \sin \left( \theta_{rm} - \sum_{j=1}^i \theta_j \right) l_i \sum_{k=1}^i \dot{\theta}_k. \end{aligned} \quad (17)$$

Using the kinematics of the nonholonomic manipulator given by (3)-(4), the equations (16) and (17) can be expressed in the matrix form as follows

$$\begin{aligned} \dot{\xi}_m &= \begin{pmatrix} \dot{l}_m \\ \dot{\tilde{\theta}}_m \end{pmatrix} = H(q_r, \xi_m) \begin{pmatrix} \dot{\theta}_1 \\ \vdots \\ \dot{\theta}_n \end{pmatrix} = \\ &= H(q_r, \xi_m) G_2(q_r) u = K_l(q_r, \xi_m) u. \end{aligned} \quad (18)$$

Matrix  $K_l(q_r, \xi_m)$  fulfills the regularity condition (i.e. it is invertible) if some configurations, which imply the matrix singularity, are excluded from a set of possibly achieved poses of the nonholonomic manipulator.

For nonholonomic 3-pendulum matrix  $K_l(q_r, \xi_m)$  has the form

$$K_l(q_r, \xi_m) = \begin{bmatrix} K_{l11} & K_{l12} \\ K_{l21} & K_{l22} \end{bmatrix},$$

with elements defined below

$$K_{l11} = \sum_{i=1}^3 l_i \cos(\theta_{rm} - \sum_{j=1}^i \theta_j),$$

$$K_{l12} = a_2 s_1 \sum_{i=2}^3 l_i \cos(\theta_{rm} - \sum_{j=1}^i \theta_j) + a_3 s_2 c_1 l_3 \cos(\theta_{rm} - \sum_{j=1}^3 \theta_j),$$

$$K_{l21} = 1 - \frac{c(s)}{1 - c(s)l_m} \sum_{i=1}^3 l_i \sin(\theta_{rm} - \sum_{j=1}^i \theta_j),$$

$$K_{l22} = a_2 s_1 \left[ 1 - \frac{c(s)}{1 - c(s)l_m} \sum_{i=2}^3 l_i \sin(\theta_{rm} - \sum_{j=1}^i \theta_j) \right] + a_3 s_2 c_1 \left[ 1 - \frac{c(s)}{1 - c(s)l_m} l_3 \sin(\theta_{rm} - \sum_{j=1}^3 \theta_j) \right].$$

Note that Frenet transformation is valid only locally, i.e.  $l_m(0) < r_{min}$ , where  $r_{min}$  is an inversion of maximal curvature  $c_{max}$  of the manipulator path  $\Pi(s)$ , therefore nominators of all fractions are well defined. In turn, the nonholonomic planar 3-pendulum cannot achieve angles equal to  $\theta_1, \theta_2 = 0, \pm\pi$ . Moreover, singularities in  $K_l$  matrix appear for  $\sin(\theta_{rm} - \theta_1) = \sin(\theta_{rm} - \theta_1 - \theta_2) = \sin(\theta_{rm} - \theta_1 - \theta_2 - \theta_3) = 0$ .

For the regular matrix  $K_l$ , the following control signals guaranteeing a convergence of tracking errors to zero for pure kinematic constraints can be proposed

$$u_r = -K_l^{-1}(q_r, \xi_m) \Lambda \xi_m, \quad \Lambda = \Lambda^T > 0. \quad (19)$$

It is easy to observe that the system (18) with closed-loop of the feedback signal (19) has a form

$$\dot{\xi}_m + \Lambda \xi_m = 0,$$

i.e. it is asymptotically stable.

### 3.2 Path Following without Desired Orientation

The manipulator with gears designed by Nakamura, Chung and Sordalen has two control inputs. It means that only two parameters can be regulated during the path following process. If we mean that the orientation of the end-effector of such manipulator is not very important, it is possible to control other Frenet parameters, e.g.  $l_m$  – distance error from the desired path and curvilinear length  $s$  of the path.

In such a case the following differential equations

$$\begin{aligned} \dot{l}_m &= \sum_{i=1}^n \cos\left(\theta_{rm} - \sum_{j=1}^i \theta_j\right) l_i \sum_{k=1}^i \dot{\theta}_k, \\ \dot{s} &= \frac{1}{1 - c(s)l_m} \cdot \sum_{i=1}^n \sin\left(\theta_{rm} - \sum_{j=1}^i \theta_j\right) l_i \sum_{k=1}^i \dot{\theta}_k \end{aligned}$$

have to be considered. Similarly to (16) and (17), using the kinematics of the nonholonomic manipulator (3)–(4), these equations can be expressed in the matrix form as follows

$$\begin{aligned} \begin{pmatrix} \dot{l}_m \\ \dot{s} \end{pmatrix} &= H(q_r, \xi_m) \begin{pmatrix} \dot{\theta}_1 \\ \vdots \\ \dot{\theta}_n \end{pmatrix} = H(q_r, \xi_m) G_2(q_r) u \\ &= K_s(q_r, \xi_m) u. \end{aligned} \quad (20)$$

Matrix  $K_s(q_r, \xi_m)$  fulfills the regularity condition (i.e. it is invertible) if some configurations, which imply the matrix singularity, are excluded from a set of possibly achieved poses of the nonholonomic manipulator.

For nonholonomic 3-pendulum matrix  $K_s(q_r, \xi_m)$  has the form

$$K_s(q_r, \xi_m) = \begin{bmatrix} K_{s11} & K_{s12} \\ K_{s21} & K_{s22} \end{bmatrix},$$

with elements defined below

$$K_{s11} = \sum_{i=1}^3 l_i \cos(\theta_{rm} - \sum_{j=1}^i \theta_j),$$

$$K_{s12} = a_2 s_1 \sum_{i=2}^3 l_i \cos(\theta_{rm} - \sum_{j=1}^i \theta_j) + a_3 s_2 c_1 l_3 \cos(\theta_{rm} - \sum_{j=1}^3 \theta_j),$$

$$K_{s21} = \frac{c(s)}{1 - c(s)l_m} \sum_{i=1}^3 l_i \sin(\theta_{rm} - \sum_{j=1}^i \theta_j),$$

$$K_{s22} = \frac{a_2 s_1 c(s)}{1 - c(s)l_m} \sum_{i=2}^3 l_i \sin(\theta_{rm} - \sum_{j=1}^i \theta_j) + \frac{a_3 s_2 c_1 c(s)}{1 - c(s)l_m} l_3 \sin(\theta_{rm} - \sum_{j=1}^3 \theta_j).$$

Singular configurations of nonholonomic 3-pendulum for the matrix  $K_s$  are equal to configurations

$$\sin(\theta_1) = \sin(\theta_1 - \theta_2) = \sin(\theta_1 - \theta_2 - \theta_3) = 0.$$

If the following control law is applied

$$u_r = -K_s^{-1}(q_r, \xi_m) v, \quad (21)$$

where  $v \in \mathbb{R}^2$  is a new input to the system (20), then we obtain the decoupled and linearized control system of the form

$$\begin{pmatrix} \dot{l}_m \\ \dot{s} \end{pmatrix} = \begin{pmatrix} v_1 \\ v_2 \end{pmatrix}. \quad (22)$$

Now it is possible to control each variable separately. For instance, if we want to move along the desired path, not only to converge to this path, it seems to be a good idea to preserve  $\dot{s} \neq 0$ . Possible choice of the control algorithm for the decoupled system (22) is

$$v_1 = -\Lambda l_m, \quad v_2 = \text{const}, \quad \Lambda > 0.$$

Such control algorithm guarantees the motion along the geometrical curve with constant velocity and, simultaneously, the convergence of the distance tracking error  $l_m$  to 0.

## 4 SIMULATIONS

As an object of a simulation study we have chosen a planar vertical 3-pendulum with nonholonomic gears mounted on a unicycle.

The desired path for the manipulator (a circle) was selected as

$$\begin{aligned} \Pi_1(s) &= 0.25 \cos 4s + 1 [m], \\ \Pi_2(s) &= -0.25 \sin 4s + 0.6 [m], \end{aligned}$$

and the desired path for the mobile platform was a straight line

$$P(s): \quad x(s) = \frac{\sqrt{2}}{2}s [m], \quad y(s) = \frac{\sqrt{2}}{2} [m].$$

The initial configuration of the manipulator was equal to  $(\theta_1, \theta_2, \theta_3)(0) = (0, 0.6732, -\pi/3)$  and initial posture of the platform was selected as  $(x, y, \theta)(0) = (0, 2, 3\pi/4)$ .

Tracking of the desired path for the mobile platform has been presented in Figures 6–8. Parameters of the Samson & Ait-Abderrahim algorithm were selected as  $v = 1$ ,  $k_2 = 0.1$  and  $k_3 = 1$ .

Tracking of the desired path with prescribed orientation for the nonholonomic manipulator 3R has been presented in Figures 9–11.

Tracking of the desired path without preserved orientation for the same manipulator has been presented in Figures 12–13.

## 5 CONCLUSIONS

In the paper the problem of defining the path for doubly nonholonomic mobile manipulators has been considered. We have proposed a new approach to the path

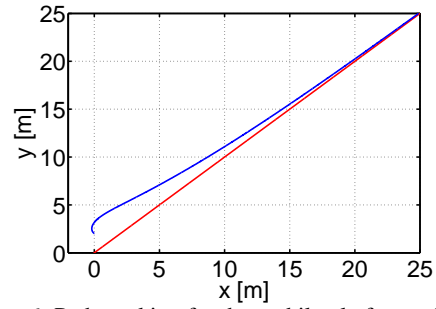

Figure 6: Path tracking for the mobile platform – XY plot.

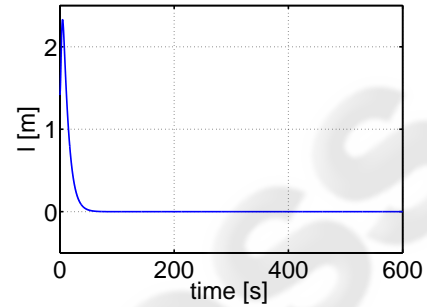

Figure 7: Path tracking for the mobile platform – distance error  $l$ .

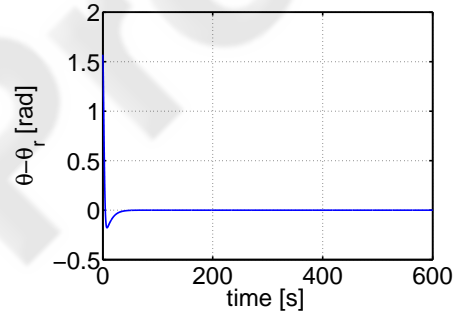

Figure 8: Path tracking for the mobile platform – orientation error  $\tilde{\theta}$ .

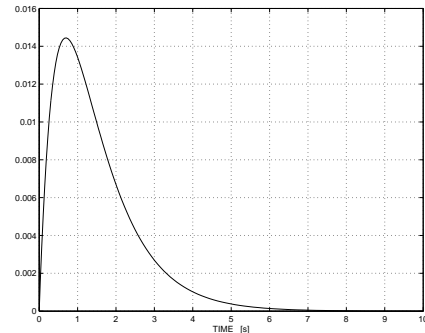

Figure 9: Path tracking for the 3-pendulum: an error of  $x$  coordinate.

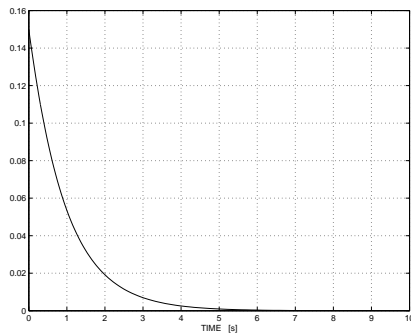

Figure 10: Path tracking for the 3-pendulum: an error of  $z$  coordinate.

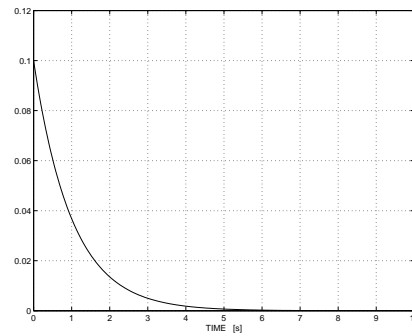

Figure 13: Path tracking for the 3-pendulum: a distance error  $l_m$ .

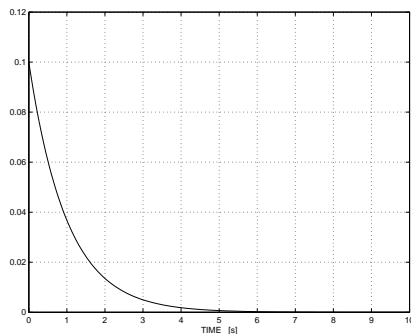

Figure 11: Path tracking for the 3-pendulum: an error of orientation  $\hat{\theta}$ .

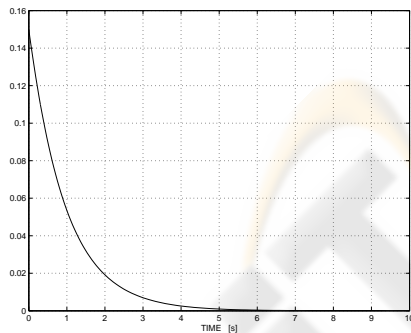

Figure 12: Path tracking for the 3-pendulum – XZ plot.

as a geometric curve defined with the orientation or not. Path following problem with prescribed orientation is very important for mobile systems, especially for mobile manipulators – it results from the fact that it is impossible to realize a task, namely unload a payload if the platform has wrong orientation during the regulation process.

In turn, for nonholonomic manipulator the desired path need not be defined with orientation. In such a case a new approach to the path following problem has been presented in the paper. A new control algorithm, guaranteeing not only asymptotic convergence to the desired path but simultaneously the motion

along the path with nonzero velocity, has been introduced. It is possible to define another kinematic control algorithms with specific properties using Frenet parametrization.

## REFERENCES

- Chung, W. (2004). Design of the nonholonomic manipulator. *Springer Tracts in Advanced Robotics*, 13:17–29.
- Fradkov, A., Miroshnik, I., and Nikiforov, V. (1999). *Non-linear and Adaptive Control of Complex Systems*. Kluwer Academic Publishers, Dordrecht.
- Mazur, A. (2004). Hybrid adaptive control laws solving a path following problem for nonholonomic mobile manipulators. *International Journal of Control*, 77(15):1297–1306.
- Mazur, A. and Szakiel, D. (2009). On path following control of nonholonomic mobile manipulators. *International Journal of Applied Mathematics and Computer Science*, 19(4):561–574.
- Michalek, M. and Kozłowski, K. (2004). Tracking controller with vector field orientation for 3-d nonholonomic manipulator. In *Proceedings of 4th int. Workshop on Robot Motion and Control*, pages 181–191, Puzoszykowo, Poland.
- Nakamura, Y., Chung, W., and Sjørdalen, O. J. (2001). Design and control of the nonholonomic manipulator. *IEEE Transactions on Robotics and Automation*, 17(1):48–59.
- Samson, C. (1995). Control of chained systems - application to path following and time-varying point-stabilization of mobile robots. *IEEE Transactions on Automatic Control*, 40(1):147–158.
- Samson, C. and Ait-Abderrahim, K. (1991). Feedback control of a nonholonomic wheeled cart in cartesian space. In *Proc. of the IEEE Int. Conf. on Robotics and Automation*, pages 1136–1141, Sacramento.
- Tchoń, K., Jakubiak, J., and Zadarnowska, K. (2004). Doubly nonholonomic mobile manipulators. In *Proceedings of the IEEE International Conference on Robotics and Automation*, pages 4590–4595, New Orleans.