

SUPPORTING MULTIMEDIA APPLICATIONS IN HOME NETWORKS USING SIP AND SLP

Min-Xiou Chen

Department of Computer Science and Information Engineering, National Dong Hwa University, Hualien, Taiwan, R.O.C.

Bing-Yang Lin, Wen-Yen Weng

Department of Computer Science and Information Engineering, Chung Hua University, Hsinchu, Taiwan, R.O.C

Keywords: Session Initiation Protocol, Session Mobility, Home Network, Open Service Gateway Initiative.

Abstract: With increased communication bandwidth the demand for home network multimedia services is increasing. A ubiquitous environment has been proposed to greatly facilitate human daily life. Service Location Protocol (SLP) provides a dynamic way to search for the location of available services and service information in the environment. Session Initiation Protocol (SIP) is an application layer signaling protocol. SIP is used to create, modify and terminate multimedia sessions. We improved SIP to support streaming service, and discover the streaming service using SLP. A prototype implementation is built to show the implementation results of our prototype.

1 INTRODUCTION

Numerous home network appliances have been developed to improve our daily life at home. Through these home networked appliances, users can remotely access and control home electrical appliances from the office. Network service can access appliances in the kitchen, living room, or bathroom. Moreover, numerous multimedia services are proliferating at an accelerated pace, such as the video blog, YouTube, and audio or video stream. With the various multimedia services, accessing, managing and searching for desired information has become a great challenge. Numerous different protocols, standards and transmission modes, such as SIP, UPnP, SLP, JXTA, and OSGi platform have been proposed for interconnection or discovery with these home networked devices and services.

Numerous researches (Wils, 2002) (Schulzrinne, 2003) (Bushmitch, 2004) (Schmidt, 2006) (Chen, 2009) were proposed in the services discovery issue. Some of the proposed architectures (Bushmitch, 2004) (Schulzrinne, 2003) (Chen, 2009) are based on the OSGi platform. With these proposed architectures for Ubiquitous computing, the users can easily search and access the heterogeneous

devices and services. Session mobility is the key issue in SIP mobility management.

Some researches (Shacham, 2009) (Rosenberg, 2004) (Sparks, 2003) (Shacham, 2005) (Chen, 2007) (Chen, 2010) were proposed in the services discovery issue. In (Shacham, 2009), the authors proposed mechanisms to provide session mobility over multiple devices. Their mechanisms involved the 3PCC (Rosenberg, 2004) control mechanism and the REFER method (Sparks, 2003). In (Shacham, 2005), the authors integrated the service discovery mechanism into the architecture proposed in (Shacham, 2009). We also proposed the session mobility over multiple devices using SIP (Chen, 2007) (Chen, 2010). In (Chen, 2007), we added the extension header "Mobility" and introduce the concept of "Association" into SIP to solve the problem of session transfer. In (Chen, 2010), we propose a complete mechanism, referred to as "Session Integration Service", to transfer and retrieve a session over multiple devices.

This research constructed a digital home environment with multimedia services. We propose and implement a home network video stream service based on SIP. The VoIP and 3GPP communities have adopted SIP as their signaling protocol choice over the past several years. SIP is an application

layer signaling protocol that can be used to create, modify and terminate sessions using one or more devices. SIP can also be used to establish one or multiple sessions including multimedia services, such as audio, video and text information. However, the video streaming services cannot be provided by SIP.

The extension header “MediaService” is added to SIP to provide video stream service. The control functions for the video stream service, such as pause and replay, are also considered in the MediaService header. To provide session mobility, we implement SIP UA based on the session integration service results proposed in (Chen, 2010). We also introduce SLP to provide service discovery in the home network. The video stream or channel name provided by the media server can be discovered and accessed using SLP and SIP.

The remainder of this paper is organized as follows. The digital home environment with multimedia services architecture is proposed in Section 2. Section 3 presents the digital home environment implementation with multimedia services. We provide the implementation results for the proposed system in Section 4 and draw our conclusions and future works in Section 5.

2 SYSTEM ARCHITECTURE

2.1 System Overview

Let us consider a scenario in which we are at home during the holidays. We would like to see some movies from a media streaming server. We may use the TV remote control or PDA to discover the streaming information from the local database in the home network. When we retrieve the streaming information from the Internet and see the movie in our living room, we may want to move this movie to the bedroom. We will need a session mobility mechanism to transfer the on-going streaming movie to the TV in the bedroom.

As we know the SIP can provide session mobility in the network, but cannot be used to create and control the video stream. Thus, we introduce an extension header “MediaService” into the SIP to provide video stream service. The system overview is shown in Figure 1. In the home network, the SLP DA is implemented in the residential gateway and the media server works as the SLP SA to register its services into the SLP DA (home DA). The Service Integrated User Agent (SIUA) is involved in the SIP UA and SLP UA functions. The SIUA can send a

service discovery message to the SLP DA in the home network. Thus, the SLP DA will reply the search results to the SIUA.

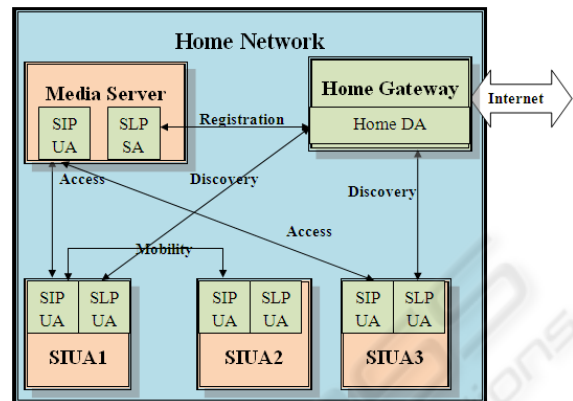

Figure 1: System Architecture.

2.2 Supporting One-way Streaming Using SIP

When the SIUA retrieves multimedia stream information from the SLP DA, the SIP is used to establish a multimedia streaming between the SIUA and media service. Thus, the extension header, “MediaService”, is introduced into the SIP. There are four fields involved in the MediaService header. The type field is one byte used to describe the streaming status provided by local services. The value 0 indicates that this message is sent from a one-way receiver and 1 indicates that this message is sent from a one-way transmission. The admin field is one byte used to describe the control command. When the value is 0, this message is used to establish a session and select a channel or file carried in the option field. When the value is 1, the control command is pause. When the value is set as 2, the control command is to play the paused stream. When the user wants to transfer the session, the admin value is 3. The length field is also one byte used to indicate the number of bytes in the option field. The option field can carry the selected channel or the selected file name.

Figure 2 shows the established streaming session procedure using the INVITE message. As shown in Figure 2, when users wanted to establish a streaming session the SIUA will send an INVITE message to the media server. The INVITE message will contain the MediaService header. The INVITE message is sent from the SIUA to the media server and the SIUA is the streaming receiver. Thus, the type field is 0. The INVITE message is used to establish a new streaming session. Thus, the admin value is 0. The

user may select channel 2. Thus, the option field value is 2 and the option field length is 1 byte. Therefore, the MediaService header value is 0012.

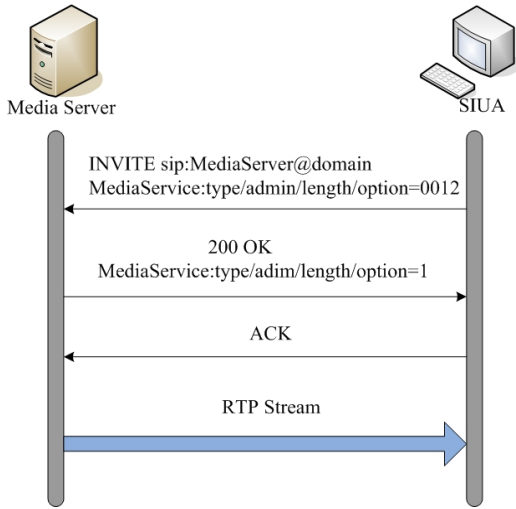

Figure 2: INVITE Streaming Session.

When the media server receives the INVITE message and the system accepts the INVITE message, the server will return a 200 OK with the MediaService header. The MediaService header value is 1 because the response message is sent from the media server, which is the streaming server. After receiving the response message, the SIUA will send the ACK message to the media server and create a streaming session between the SIUA and the media server.

When users want to pause a streaming session the SIUA will send an INVITE message to the media server with the MediaService header and the value is 01. When the media server receives the pause message, the media server will stop packet transmission and reply with a 200 OK with the MediaService header. The MediaService header value will then be 11. When users wanted to replay the streaming session, SIUA will send an INVITE message to the media server with the MediaService header and a value of 02. After receiving the replay message, the media server will reply with a 200 OK with the MediaService header (value is 12) and start packet transmission. The detailed procedures are shown in Figure 3.

We introduce the REFER mechanism and the Nested REFER mechanism to provide session mobility. As shown in Figure 4, the SIUA1 will transfer the session between the SIUA1 and media server to the SIUA2. The SIUA1 will send a pause message to the media server. The SIUA1 will then send a REFER message to the SIUA2 and the

MediaService header value will be 03. After receiving the REFER message the SIUA2 will send an INVITE message with the MediaService header (value is 03) to the media server. When the media server receives the INVITE message and the system finds that this message is a referral message from the MediaService header, the media server will return with a 200 OK, transfer the session with the SIUA1 to the SIUA2.

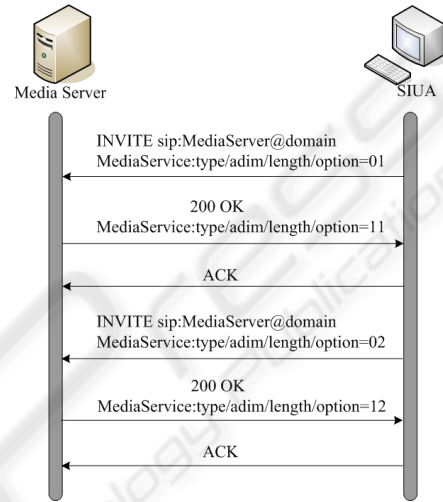

Figure 3: Pause and Replay Procedures.

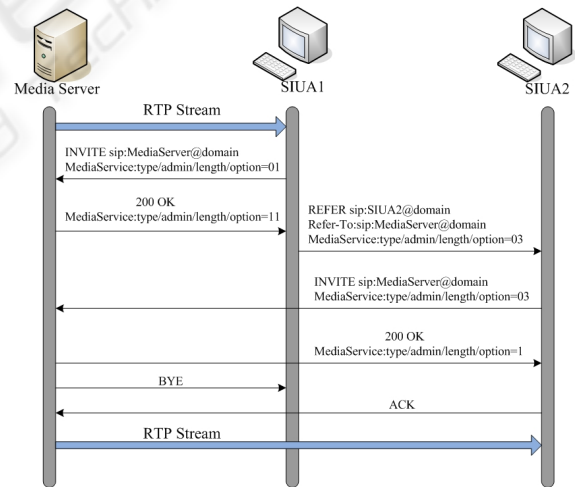

Figure 4: Session Mobility.

As shown in Figure 5 when the SIUA1 retrieves a session that is transferred to the SIUA2, the SIUA1 will send the Nested REFER mechanism to the SIUA2 and the MediaService header value will be 03. After receiving the Nested REFER message the SIUA2 will send a REFER message to the SIUA1, and the MediaService header value will still be 03. Moreover, the SIUA2 will also send a pause

message to the media server. After receiving the REFER message, the SIUA1 will send an INVITE message with the MediaService header (value is 03) to the media server. When the media server receives the INVITE message and the system finds that this message is a referral message from the MediaService header the media server will return with a 200 OK, transfer the session with the SIUA2 to the SIUA1.

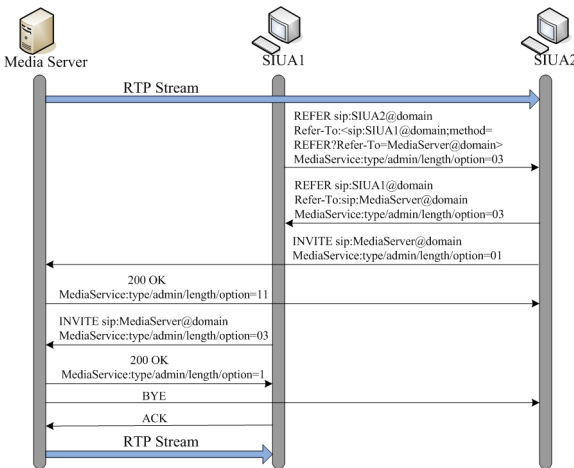

Figure 5: Retrieval session.

3 SYSTEM IMPLEMENTATION

We integrated the SLP UA and SIP UA functions into the Service Integrated User Agent (SIUA). We implemented the SIUA based on the SIP communicator project. We also integrated the SLP SA and SIP UA functions into the media server, and implemented the media server over the J2SE. We need to register the service information into the SLP DA. Thus, we installed the open-source code for Maven jSLP into the residential gateway proposed in (Chen, 2009), which was implemented based on the open-source project of the OW2 Forge Oscar.

In our implementation, the jSLP is installed into the residential gateway, which is implemented based on the open-source project of the OW2 Forge Oscar. In (Chen, 2009), we added an SLP bridge bundle, referred to as "SACP". The SACP works as SLP SA discovers the UPnP devices and services from the Service Registry of the OSGi platform and registers these services and devices into the SLP DA. With the SACP, the residential gateway can provide automated heterogeneous devices discovery, registry and management.

Figure 6 shows the multimedia home network architecture. As shown in Figure 6, the media server

is involved in the SLP SA, SIP UA, and Media Content. The SLP SA announces its service information into the SLP DA. The SIP UA is used to process the SIP signal procedure, such as session established, session mobility and streaming control. The Media Content is used to maintain the RTP connection for the one-way streaming service.

The SIUA contains the SLP UA and SIP UA functions and we implement the SIUA based on the SIP communicator, as shown in Figure 7. The SIP communicator has two major modules for network communication. The Sip Manager is used to process the SIP signaling function and the MediaManager is used to maintain the RTP session. When the SIUA wants to create a streaming session, the SipManager will use the SendRequest() function to send the INVITE message to the media server. When media server wants to reply to the message, SipManager will use SendOK() function to reply to the message. The MediaManager will then create a RTP session between the media server and SIUA, and use the SendStream() function to send the packets.

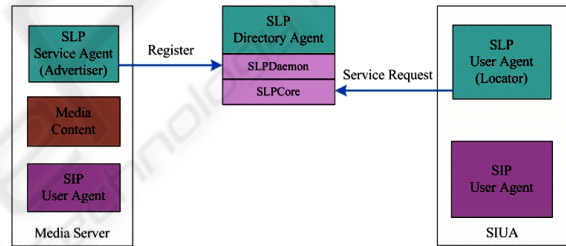

Figure 6: The Multimedia Home Network Architecture.

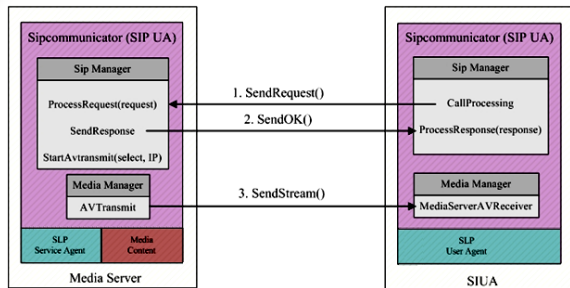

Figure 7: The SIP UA Streaming Service Architecture.

4 IMPLEMENTATION RESULTS

As shown in Figure 1, we conducted experiments with our prototype implementations to ensure the location service ability and streaming service session mobility. In the first approach, the media server registers the streaming services into the server. The

SIUA1 then sends a Service Request to the DA1 to discover the streaming service, as shown in Figure 8. When the SIUA1 receives the Service Reply, the streaming service information will be shown on the GUI, as shown in Figure 9.

The SIUA1 and media server then create a streaming session. The SIUA1 will then transfer the session to the SIUA2, as shown in the left of Figure 10, and the session between the SIUA1 and media server will be transferred to the SIUA2 and media server, as shown on the right side of Figure 10. Finally, the SIUA1 will retrieve the session between the SIUA2 and media server, as shown in Figure 11.

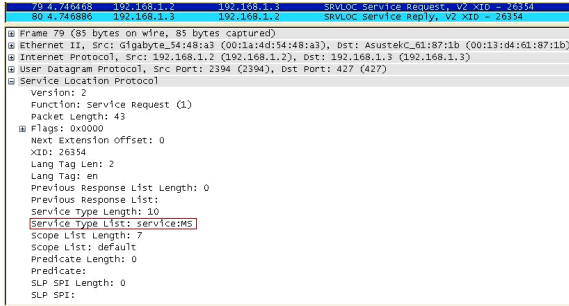

Figure 8: SLP Service Request Packet.



Figure 9: SLP Request Search Results.



Figure 10: Session Mobility.

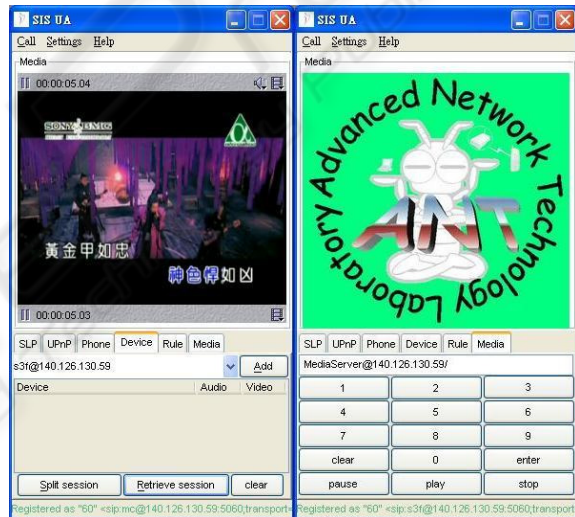

Figure 11: Retrieval Session.

Figure 12 shows the media server packet traffic. From Figure 12, we can find that the SIUA1 creates a streaming session with the media server after 9 seconds, and the traffic between the SIUA1 and media server is increased after 9 seconds. The SIUA1 transfers the session to the SIUA2 after 17 seconds, the traffic between the SIUA1 and media server is empty and the traffic between the SIUA2 and media server is increased after 17 seconds. The SIUA1 retrieves the session, the traffic between the SIUA1 and media server is increased and the traffic between the SIUA2 and media server is empty after 24 seconds.

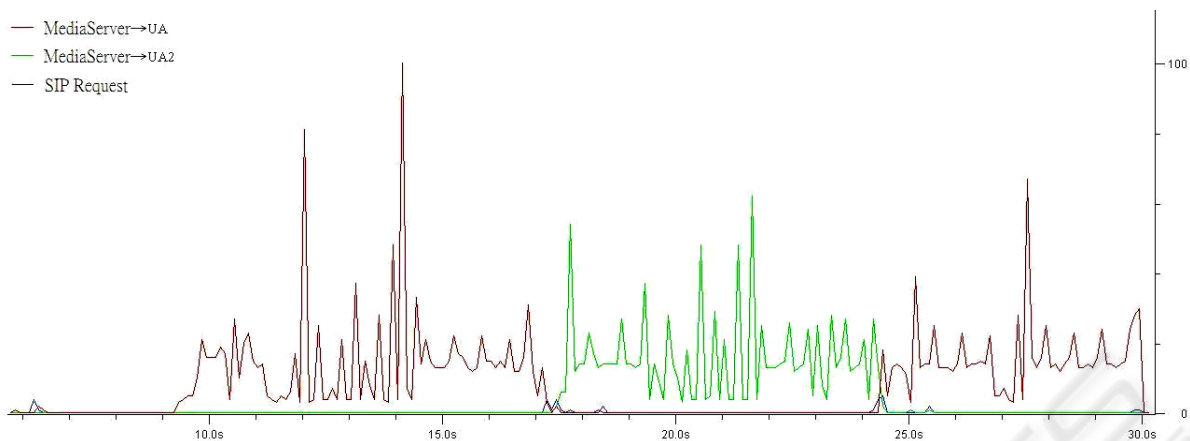

Figure 12: Packet Traffic of Media Server.

5 CONCLUSIONS AND FUTURE WORKS

The Internet has grown to an enormously large scale, with ubiquitous computing receiving increased attention over the past few years. In a home network, providing service discovery and multimedia services has become a great challenge. This paper proposed and implemented a video stream service for a home network based on SIP. The MediaService header was added into the SIP to provide video stream service. With the MediaService header and REFER method, streaming service session mobility can be provided. With the SLP, the SIUA can discover services from the SLP DA and access the media streaming from the media server. Application examples were introduced and the implementation results show the ability of the proposed architecture. In the future, we will extend our proposed architecture with OSGi platform capabilities to support an intelligent Home network system and intelligent Vehicle network system.

ACKNOWLEDGEMENTS

This work was supported by the National Science Council of Taiwan, R.O.C. under Grant NSC96-2221-E-216-010, NSC97-2221-E-259-036, and NSC98-2221-E-259-014.

REFERENCES

Bushmitch, D., Lin, W., Bieszczad, A., Kaplan, A., Papageorgiou, V., and Pakstas, A., 2004. A SIP-based

device communication service for OSGi Framework. *IEEE Consumer Communications and Networking Conference*.

Chen, M., Peng, J., and Hwang, R., 2007. SSIP: Split a SIP Session over Multiple Devices. *Computer Standards and Interfaces*, Vol. 29, No. 5 pp. 531-545.

Chen, M., and Tzeng, T., 2009. Heterogeneous Service Location Service Architecture Based on OSGi Technology. *International Conference on Advanced Communication Technology*.

Chen, M., and Wang, F., 2010. Session Integration Service over Multiple Devices. *International Journal of Communication Systems*, Vol. 23, No. 5, pp. 673-690.

Rosenberg, J., Peterson, J., Schulzrinne, H., and Camarillo, G., 2004. Best Current Practices for Third Party Call Control (3PCC) in the Session Initiation Protocol (SIP). *IETF RFC 3515*.

Schmidt, H., Guenkova-Luy, T., and Hauck, F.J., 2006. Service Location Using The Session Initiation Protocol (SIP). *International Conference on Networking and Services*.

Schulzrinne, H., Wu, X., Sidirolglou, S., and Berger, S., 2003. Ubiquitous Computing in Home Networks. *IEEE Communications Magazine*, Vol 41, No. 11, pp. 128-135.

Shacham, R., Schulzrinne, H., Thakolsri, S., and Kellerer, W., 2005. The Virtual Device: Expanding Wireless Communication Services through Service Discovery and Session Mobility. *IEEE International Conference on Wireless and Mobile Computing, Networking And Communications*.

Shacham, R., Schulzrinne, H., Thakolsri, S., and Kellerer, W., 2009. Session Initiation Protocol (SIP) Session Mobility. *IETF RFC 5631*.

Sparks, R., 2003. The Session Initiation Protocol (SIP) Refer Method. *IETF RFC 3515*.

Wils, A., Matthijs, F., Berbers, Y., Holvoet, T., and De Vlaminck, K., 2002. Device discovery via residential gateways. *International Conference on Consumer Electronics*.