

A COMPETING ALGORITHM FOR GRADIENT BASED ROUTING PROTOCOL IN WIRELESS SENSOR NETWORKS

Lusheng Miao, Karim Djouani, Anish Kurien and Guillaume Noel
French South African Institute of Technology, Tshwane University of Technology
Staatsartillerie Road, Pretoria, South Africa

Keywords: Wireless sensor networks, Gradient-based routing, Energy efficiency.

Abstract: The energy consumption is a key design criterion for the routing protocol in wireless sensor networks. Some routing protocols deliver the message by point to point like wire networks, which may not be optimal to maximise the lifetime of the network. In this paper, a competing algorithm for GBR in wireless sensor networks is proposed. This algorithm is referred to as GBR-C. Furthermore auto-adaptable GBR-C routing protocol is proposed. The proposed schemes are compared with the GBR protocol. Simulation results show that the proposed schemes give better results than GBR in terms of energy efficiency.

1 INTRODUCTION

Wireless Sensor Networks (WSNs) consist of intelligent sensor nodes with sensing, computation, and wireless communications capabilities. Routing in WSNs is challenging since sensor nodes are strongly constrained in terms of energy, computational power, and storage capacities. The limited energy supply is critical for the development of WSNs. As a result, the core question to be answered for WSNs is to determine how to save energy in order to prolong the lifetime of the network.

Gradient-based routing (GBR) is a routing protocol for WSNs proposed by C. Schurgers and M.B. Srivastava (2001). Al-Karaki, J.N and Kamal, A.E (2004) prove that GBR is reliable in choosing the shortest route to a sink while balancing the energy of the whole network. However, shortcomings exist in the GBR scheme such as nodes which deliver the message in a point to point manner and do not use the broadcast nature of wireless networks. Wireless sensors are usually equipped with omnidirectional antennas and are placed environment with potential of data retransmissions are high. This in turn significant multipath transmissions so that if one node sends a message, all its neighbors have the potential of receiving this message. However, due to the characteristics of the wireless channel, the number

greatly affects the energy consumption of the network. The retransmission can be reduced if the best node, which has already received this message, can be selected from its neighbors to transmit this message forward. However, very little research has focused on GBR in term of energy saving by considering the effect of the retransmission. Hence, in this project, a competing algorithm which uses the broadcasting nature of the wireless environment is developed to improve GBR in terms of energy efficiency.

The rest of the paper is organized as follows. In Section 2, related work is discussed. The energy consumption of GBR is analyzed in Section 3. In Section 4, the competing policy and the energy consumption analysis are proposed; furthermore an auto-adaptable GBR-C protocol is proposed. Simulations and results are presented in Section 5. Conclusions and future work are given in Section 6.

2 RELATED WORK

The basic idea of competing algorithm is to exploit the spatial diversity of the wireless medium by involving a set of candidate forwarders instead of only one in traditional routing, and then one forwarder which has already received the packet is chosen as the actual relay.

Miao L., Djouani K., Kurien A. and Noel G. (2010).

A COMPETING ALGORITHM FOR GRADIENT BASED ROUTING PROTOCOL IN WIRELESS SENSOR NETWORKS.

In *Proceedings of the International Conference on Wireless Information Networks and Systems*, pages 82-89

Copyright © SciTePress

H. Fussler, et al., (2003) propose a contention-based forwarding scheme (CBF), in CBF the source node broadcast packet to all its neighbours and then select one best node to forward the packet. Furthermore, the authors propose three suppression algorithms, Basic suppression scheme, Area-based suppression and Active selection, to prevent multiple next hops and thereby packet duplication. However, duplication still occurs in Basic suppression scheme and Area-based suppression, Active selection can prevent all forms of packet duplication but with additional overhead.

M. Zorzi and R. R. Rao (2003) propose a novel forwarding technique based on geographical location of the nodes involved and random selection of the relaying node via contention among receivers. The receivers which are closer to the destination have the higher priority to forward the packet, which also means that the closer nodes to the destination are always selected and overused.

S. Biswas and R. Morris, (2005) propose ExOR, an integrated routing and MAC protocol that increases the throughput of large unicast transfers in multi-hop wireless networks. ExOR operates on batches of packets, the source nodes includes a list of candidate forwarders in each packet, prioritized by closeness to the destination, the receivers with highest priority forward packets, and then the remaining forwarders forward the packet which were not forwarded by the higher priority forwarders.

K. Zeng, et al., (2008) propose an algorithm to set the forwarder priorities depending on the expected advancement (EPA) rate in order to achieve the maximum end-to-end throughput.

All of these works do not consider the energy efficiency of the network, and the source node broadcast the packet to all its neighbours which wastes the energy of the nodes. K. Zeng, et al., (2007) propose an EPA per unit energy consumption model, which calculates the best number of forwarding candidates to broadcast the packet in order to achieve the best energy efficiency. However in this model, the source node needs the knowledge of the real time delivery reliability for each neighbour which is hard for the real wireless sensor networks.

3 ENERGY CONSUMPTION ANALYSIS

It is known that limited energy supply is a very critical restriction for WSNs and that routing

protocols used in WSNs should cater for this feature. In this section the energy consumption of GBR is analyzed. Shortcomings in the protocol are exposed.

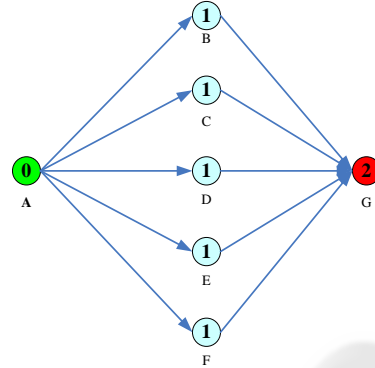

Figure 1: Two hop wireless sensor network.

Considering a simple two hop wireless sensor network as shown in Figure 1, Node A has five next hop nodes (determined by back propagation in GBR) and needs to send a message to node G. In the GBR framework, node A chooses one next hop node among node B, C, D, E or F. Assuming the power consumption of sending is p_{TX} while the energy overhead of receiving is p_{RX} . Assume that the data message size is M and the bit rate is *Bitrate*. The transmission probability p is referred to as the probability for one link that the receiver receives the message successfully. To simplify the problem, the energy consumption for the data transmission is only considered and the other energy consumptions are ignored. The one hop transmission energy consumption for GBR can be determined as

$$E = (p_{TX} + p_{RX}) * \Delta T. \quad (1)$$

Where ΔT is the transmission time and can be determined as

$$\Delta T = \left(\frac{M}{p}\right) / \text{Bitrate}. \quad (2)$$

Equation (1) and (2) can be rewritten as

$$E = \frac{(p_{TX} + p_{RX})}{\text{Bitrate}} * \left(\frac{M}{p}\right). \quad (3)$$

However, it can be seen that node A has five next hop nodes. Due to the broadcast characteristic of wireless, any of the node A's neighbour could receive node A's message. As a result, if node A sends the data to more than one next hop nodes, assuming that the number of next hop nodes is n ,

then the probability that at least one next hop node received the data is

$$P_n = 1 - (1 - p)^n. \quad (4)$$

The one hop transmission energy consumption can be determined from (3) and (4) as

$$E = \frac{(p_{TX} + n \cdot p_{RX})}{\text{Bitrate}} \left(\frac{M}{1 - (1 - p)^n} \right) \quad n = 2, 3, 4, 5 \quad (5)$$

When $n=1$, equation (5) is equivalent to equation (3). Equation (5) and (3) can be rewritten as

$$E = \frac{(p_{TX} + n \cdot p_{RX})}{\text{Bitrate}} \left(\frac{M}{1 - (1 - p)^n} \right) \quad n = 1, 2, 3, 4, 5. \quad (6)$$

Assuming the Mica2 power consumption model (Shnayder.V, et al., 2004) is used and p is set as $0.4 \leq p \leq 1$, then the energy consumption for n from 1 to 5 can be determined. The results obtained are shown in Figure 2.

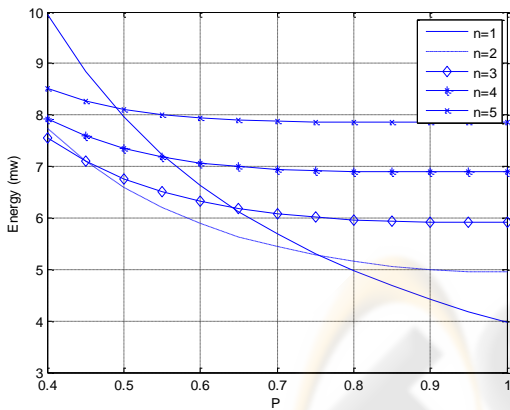

Figure 2: The energy consumptions ($p_{TX} = 65mw/sec$, $p_{RX} = 21mw/sec$, $M=800$ bits, $\text{Bitrate}=19200$ bits/sec.).

It can be seen that energy can be saved if we set $n=2$ for $P < 0.75$. This can save up to 23% energy for one hop transmission. Furthermore, it can be also seen that it is enough to set at most two next hop nodes when $0.45 \leq p \leq 1$. In this work, the setting up of at most two next hop nodes according to the transmission probability P as shown in Table.1 is considered.

Table 1: Next hop nodes number.

Transmission Probability	Next Hop Nodes Number
$P \geq 0.75$	$n=1$
$P < 0.75$	$n=2$

4 COMPETING ALGORITHM

In Section 3, it was shown that the transmission energy can be saved by adapting the next hop nodes number. However in real networks, we need to know which node should transmit the data forward. For example, in Figure 1, assume that node A needs to send a data packet to node G. Suppose node A has already chosen node C and D as its next hop nodes. Then, between node C and D, it should be determined which node should transmit the data packet to node G. To solve this problem, a competing algorithm for GBR is designed.

4.1 Competing Algorithm

Before the competing algorithm is discussed, the communication model used and the three kinds of message used are defined.

Reliable Communication Model: This implies that the communication is such that the messages are guaranteed to reach their destination complete and uncorrupted. Some special measures are taken to re-send information that did not arrive the first time. For example, transmission is made reliable via the use of sequence numbers and acknowledgments.

DATA: This refers to the data packet which needs to be transmitted through the network.

ACK&DACK: These are the transmission control characters used to indicate that a transmitted message was received uncorrupted or without errors. The receiver sends an ACK or DACK to the sender depending on the destination nodes number of the received message. If the message only has one destination node, then the receiver sends an ACK. Otherwise it sends a DACK.

TOGO: This is a signal that asks a node to transmit the data message forward.

In WSNs, the messages are delivered through the network by multi-hop and reliable communication is very important for each hop transmission. Hence, in this paper, wireless sensor networks which work with reliable communication model are focused on.

The details of the competing algorithm are shown in Figure 3:

- 1) The source node sends a data message to receiver(s).
- 2) The receiver receives the message. If the message is received successfully, then it will check the destination address list of this message.

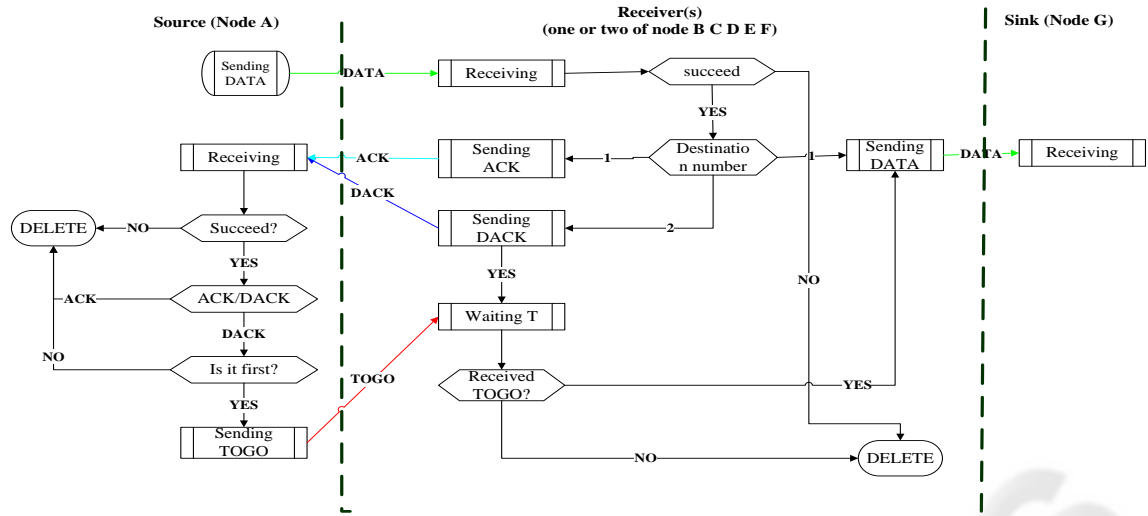

Figure 3: The competing algorithm flow chart.

- 3) If the destination address number is one, then the receiver transmits this message to the sink immediately. In addition, for the reliable communication network, the receiver also needs to send an ACK message to the sender.
- 4) If the destination address number is two, then the receiver sends a DACK message to the source. Then a waiting time T (for example 1s) is set.
- 5) The source receives the message and then checks the message type. If it is an ACK message, it then deletes it. If it is a DACK message, then the source node checks if it is the first DACK message for the data message which it sent before. If it is the first, then the source node sends a TOGO message to the sender of the DACK message. Otherwise, it deletes it.
- 6) If the receiver receives a TOGO message in the waiting time T, then it transmits the message to the sink; otherwise, deletes the message.

The above algorithm which adopts a competing algorithm for the GBR protocol is referred to as GBR-C.

4.2 Energy Consumption Analysis

In section 3, the energy consumption for one hop transmission was discussed. However, only the data transmission was focused on. As a result, the analysis was not very comprehensive and accurate. In this section the energy consumption with the competing algorithm is analyzed.

The same power consumption model used in Section 3 is used. The ACK&DACK message size is $(D)ACK=32 \text{ bits}$, the Togo message size is $Togo=32 \text{ bits}$. In addition, compared to the data message, the ACK and Togo message is very short. As a result, their packet error rates are much lower than the data message's. In this case, we do not consider their packet error rates.

Considering the ACK&DACK and Togo messages, the energy consumption for GBR-C is determined from (6) as

$$E = \begin{cases} \frac{P_{TX} + P_{RX}}{\text{Bitrate}} \left(\frac{M}{p} + ACK \right) & n = 1 \\ \frac{P_{TX} + n \cdot P_{RX}}{\text{Bitrate}} \left(\frac{M}{1 - (1-p)^n} \right) + & (7) \\ \frac{P_{TX} + P_{RX}}{\text{Bitrate}} (n \cdot P \cdot (D)ACK + TOGO) & n > 1 \end{cases}$$

If we set $0.4 \leq p \leq 1$, then the energy consumption for GBR and GBR-C can be determined. The results obtained are shown in Figure 4.

It can be seen that energy can be saved if GBR-C is used when $P < 0.71$. A saving of up to 22% energy for one hop transmission is seen when $p=0.4$. As a result, it can be concluded that GBR-C can save energy when the transmission probability P is less than a certain threshold. The threshold may be different for different application networks. For this example, the threshold is 0.71.

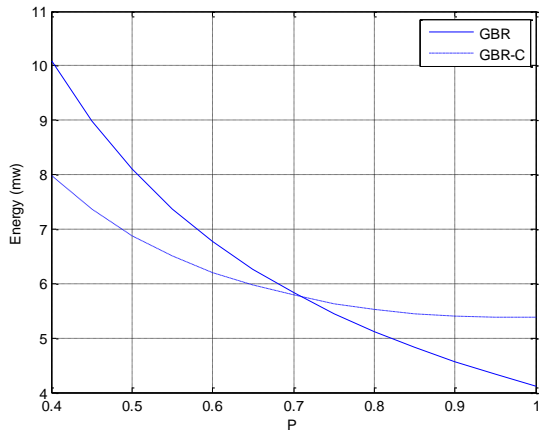

Figure 4: The energy consumptions for GBR and GBR-C.

Table 2: Next hop nodes number.

Transmission Probability	Next Hop Nodes Number
$P \geq 0.71$	n=1 GBR
$P < 0.71$	n=2 GBR-C

4.3 Auto-adaptable GBR-C Protocol

In the former section, it was concluded that GBR-C has the potential of saving energy when the transmission probability P is less than a certain threshold. However, in real networks, sometimes it is hard to know the value of P before networks are deployed. To overcome this, in this section, an algorithm is proposed which can make nodes adapt their next hop nodes numbers automatically according to the transmission probability P . The new protocol with this algorithm is referred to as auto-adaptable GBR-C protocol.

The main idea of this algorithm is to keep calculating the real time transmission probability. For a reliable communication model, every sender will wait for an ACK message after it sends a data message. So the transmission probability can be obtained by recording the send number and the ACK number. Firstly, variables used to record numbers which will be used to calculate the transmission probability are defined.

Sn is used to record the number of the data message that this node has already sent.

Rn is used to record the number of the ACK or DACK message that this node has already received.

P refers to the real time transmission probability that we are looking for.

The details of this algorithm are as follows:

- 1) p is initialized as one.
- 2) Each node checks the value of p before it sends a data message. If p is less than the

threshold ($p=0.71$), then this node sets two next hop destination nodes for this data message, otherwise it sets one.

- 3) Sn will be increased when the node sends a data message. Sn will be increased by 1 if this data message has only one next hop destination node. It will be increased by 2 if this data message has 2 next hop destination nodes.
- 4) Then, the node will wait for the ACK or DACK message and Rn will be increased by 1 when the node has received an ACK or DACK message.
- 5) The node calculates its transmission probability by the equation $P=Rn/Sn$, and then returns to step 2).

The energy consumption that is obtained for the auto-adaptable GBR-C protocol is shown in Figure 5.

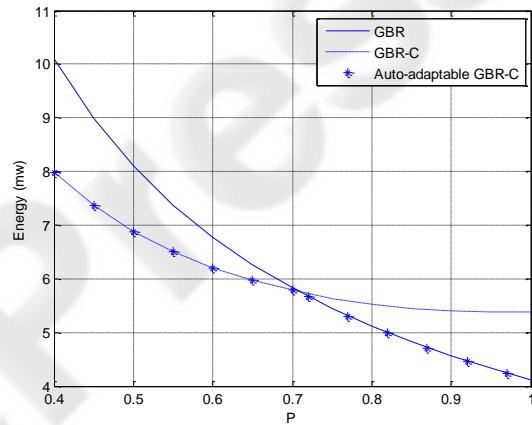

Figure 5: The energy consumption for auto-adaptable GBR-C.

5 SIMULATION & RESULTS

The competing algorithm protocols GBR-C and auto-adaptable GBR-C were implemented in the Omnet++ network simulator. The results obtained were compared with the GBR protocol.

5.1 Simulation Configurations

In our simulations, two wireless sensor networks were considered. One is a regular network which is shown in Figure 6 (a) with 11 static sensor nodes deployed inside a rectangle field regularly with one sink and one source. The other one is a random network shown in Figure 6 (b) with 50 static sensor nodes deployed inside a rectangle field randomly

with one sink and four sources. For the regular network, each node has a fixed radio range of 300 meters. For the random network, each node has a fixed radio range of 200 meters. The positions of the sources and sinks are shown in Figure 6. In these configurations, the sinks and sources are located far from each other which facilitate the evaluation of the protocol where the routing path has to traverse a large area in the sensor field.

The EnergyFramework-2.0 provided in the Omnet++ is used and each node is assigned with the same initial energy capacity of 40 J at the beginning of each simulation. The energy consumption is further set for sending time and receiving time as 65mw/sec and 21mw/sec respectively (The same parameters as Mica2 power consumption model). In addition, W. Ye, et al., (2002) have showed that compared to sending and receiving, the sleeping time consumption is very small. As a result, the

sleeping time energy consumption is ignored and set to 0. The B-MAC layer (Joseph Polastre, et al., 2004) is used, the MAC bit rate and the messages length are set as same as in Section 3. The simulation steps are as follows:

- 1) Sinks broadcast interest message through the whole network, and the interest will be resent every 1500 seconds.
- 2) Sources gather and sends data to the sinks every 30 seconds.
- 3) Stop simulating when the sink has received a certain number (300 for regular network, 1000 for random network) of messages from sources.
- 4) Output the simulation data.

5.2 Results and Discussion

Figure 7 shows the remaining energy for the regular network after the simulation under different transmission probability setting. Here the probability is set by dropping a certain percent packet, such as $p=0.88$ which means 12% messages is dropped by each node. It can be observed that GBR-C uses less energy than GBR to deliver the same number of messages when the transmission probability p less than 0.79 which verifies the conclusion that GBR-C has the potential to save energy when the probability P is less than a certain threshold. Compared to GBR, GBR-C can save up to 18% energy when $p=0.58$ for 4 hops transmission. However, the simulation result shows that the threshold is $p=0.79$ and it is a little higher than 0.71 which was obtained in Section 4.2. In this simulation, as well as in some real networks, the messages will be dropped after three failure transmissions. GBR-C chooses one more next hop nodes to transmit the message which can reduce the number of dropped messages in the intermediate nodes. As a result, in a real network, it is shown that the GBR-C can save more energy than in theory. This is why the simulation threshold value is 0.79 which is greater than the theoretic value 0.71.

Figure 7 also shows that the auto-adaptable GBR-C is like GBR when $p=0.88$ which is greater than the threshold $P=0.71$ and is like GBR-C when $p=0.58$ which is less than the threshold. The simulation results showed that for all network environments, the auto-adaptable GBR-C performed better in terms of energy efficiency.

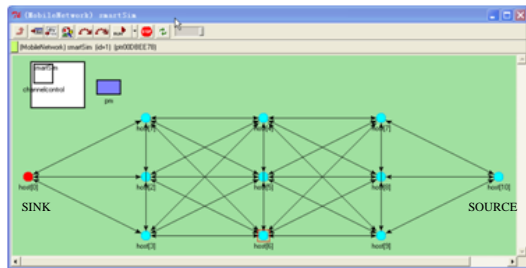

(a)

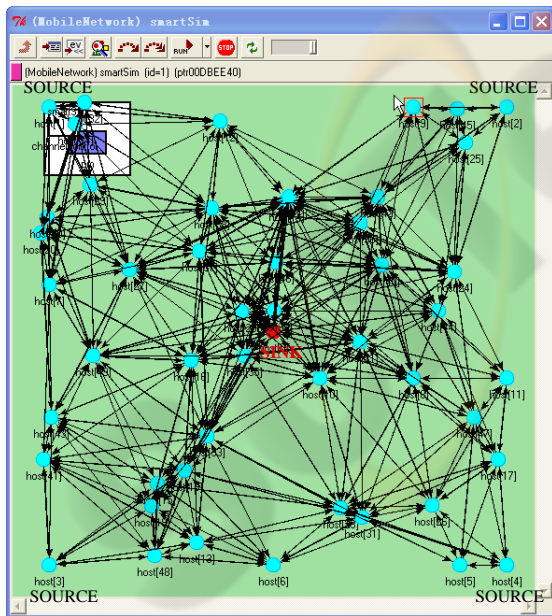

(b)

Figure 6: The simulation networks: (a) Regular wireless sensor network; (b) Random wireless sensor network.

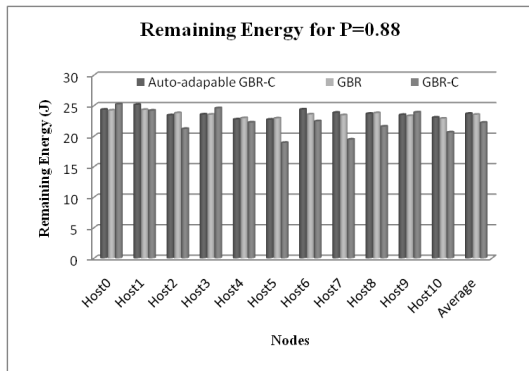

(a)

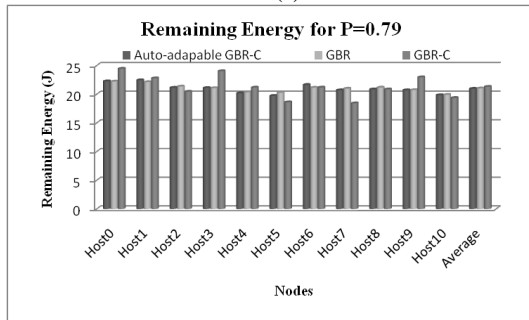

(b)

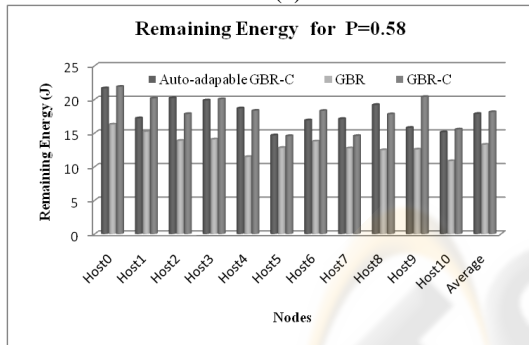

(c)

Figure 7: The remaining energy histogram for regular network with different transmission probability: (a) p=0.88 (b) p=0.79 (c) p=0.58.

Figure 8 shows the remaining energy for the random network after the simulation. In this network, the transmission probability for each node is $0.1 \leq p \leq 1$, the average transmission probability for the whole network is $p=0.63$. It can be observed that the auto-adaptable GBR-C performs better in terms of energy efficiency for this random wireless sensor network.

Figure 9 shows the average transmission delays for the regular network under different transmission probability. It can be observed that GBR-C has a little longer delay than GBR. This is because GBR-C uses the competing algorithm for every hop

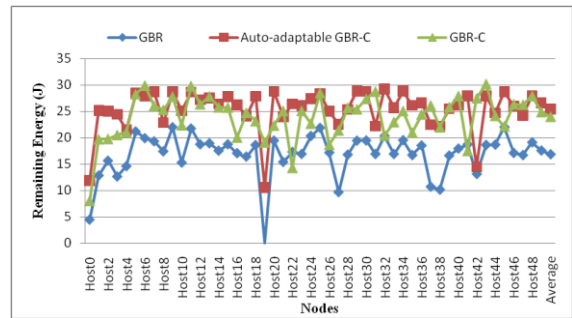

Figure 8: The remaining energy for random network.

transmission and needs to wait for the TOGO message before sending the message. For the auto-adaptable GBR-C, the transmission delay is close to GBR when p is greater than the threshold and close to GBR-C when p is less than the threshold. It also can be observed that the delay of GBR increases faster than GBR-C when p decrease. This is because that GBR-C reduces the probability of retransmission and saves retransmission delay. Herewith, the delay of GBR-C could shorter than GBR with a certain p and a short waiting time for TOGO.

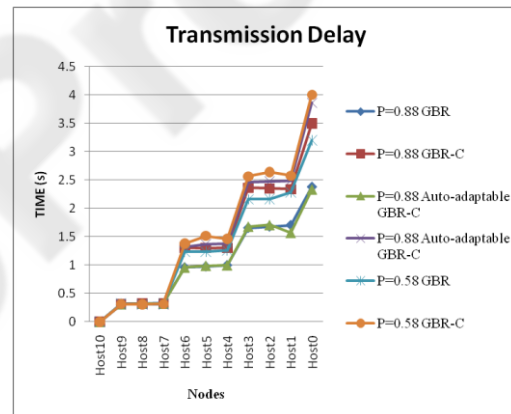

Figure 9: The transmission delay.

6 CONCLUSIONS

In this paper, a competing algorithm for GBR in wireless sensor networks was proposed. Furthermore, an Auto-adaptable GBR-C routing protocol for wireless sensor networks was proposed. The competing algorithm aims to reduce the retransmission attempts and save the energy by considering two next hop nodes. Simulation results showed that the proposed scheme has higher energy efficiency than the GBR, but with a little longer

transmission delay. In the future, studies will be carried out to find transmission probability threshold more accurately and to reduce the transmission delay.

ACKNOWLEDGEMENTS

The authors would like to thank F'SATI at Tshwane University of Technology and Telkom Centre of Excellence program for making this research possible.

REFERENCES

- C. Schurgers and M. B. Srivastava, 2001. Energy efficient routing in wireless sensor networks. In the MILCOM *Proceedings on Communications for Network-Centric Operations: Creating the Information Force*, McLean, VA.
- Al-Karaki, J. N and Kamal, A.E, 2004. "Routing techniques in wireless sensor networks: a survey." In the Wireless Communications, *IEEE*., page(s): 6- 28.
- Shnayder, V., Hempstead, M., Chen, B., Allen, G. W., and Welsh, M., 2004. "Simulating the power consumption of large-scale sensor network applications." In *Proceedings of the 2nd international Conference on Embedded Networked Sensor Systems* (Baltimore, MD, USA).
- W. Ye, J. Heidemann, and D. Estrin., 2002 . "An Energy-Efficient MAC Protocol for Wireless Sensor Networks." In *Proceedings of the 21st International Annual Joint Conference of the IEEE Computer and Communica.*
- Joseph Polastre, Jason` Hill, David Culler, 2004. "Versatile Low Power Media Access for Wireless Sensor Networks," *ACM Sensys*.
- H. Fussler, J. Widmer, M. Kasemann, M. Mauve, and H. Hartenstein, 2003. "Contention-based forwarding for mobile ad-hoc networks," Elsevier's Ad Hoc Networks, vol. 1, no. 4, pp. 351-369.
- M. Zorzi and R. R. Rao, 2003. "Geographic random forwarding (geraf) for ad hoc and sensor networks: energy and latency performance," *IEEE*.
- S. Biswas and R. Morris, 2005. "Exor: Opportunistic multi-hop routing for wireless networks," in *SIGCOMM'05, Philadelphia*, Pennsylvania.
- K. Zeng, W. Lou, and H. Zhai, 2008. "On end-to-end throughput of opportunistic routing in multirate and multihop wireless networks," in *Proceedings of the Annual Joint Conference of the IEEE Computer and Communications Societies (INFOCOM '08)*, pp. 1490-1498, Phoenix, Ariz, USA.
- K. Zeng, W. Lou, J. Yang and D. Brown, 2007. "On geographic collaborative forwarding in wireless ad hoc and sensor networks," in *WASA'07*, Chicago, IL.