

DEVELOPMENT OF EMERGENCY MONITORING SYSTEM FOR ELDERLY WHO LIVE ALONE

Dong Ik Shin, Pil June Pak

Dept. of Biomedical Engineering, Asan Medical Center, Seoul, Korea

Ji Hoon Song

SooEe Electronics Co., SeongNam, Korea

Se Kyeong Joo, Soo Jin Huh

Dept. of Biomedical Engineering, University of Ulsan College of Medicine, Ulsan, South Korea

Keywords: Emergency monitoring, Vital sign, Pulse Oxymetry, Elderly, Accelerometer.

Abstract: In this paper, we introduce a mobile device for the monitoring of the elderly vital signs. Using this mobile device, we composed the emergency monitoring system. There are so many vital signs to monitor, but we simplified vital signs as activity and heart rate. We measured the activity using 3-axis accelerometer and measured the heart rate using pulse oxymeter. The major problem of pulse oxymeter is motion artifact. But we suggested a new method using the combination of these two sensors. In case of active motion, we used and analyzed the accelerometer signal and withdraw the pulse oxymeter signal. In case of no activity, we adopt pulse oxymeter signal which has no motion artifacts. The important thing is to categorize activity patterns such as normal or abnormal activity. When the device detects abnormal condition, it sends a short message to server and then connected to the u-Healthcare center or emergency center.

1 INTRODUCTION

Nowadays u-healthcare already be a trend of these years with IT/BT technologies. And, another point of view, we must focus on the single elderly who must be cared in terms of activity and vital signs of them. This is very important social problem to solve. According to the statistics Korea, the aging index increasing fast in annual. So, there are needs of emergency monitoring for single elderly. Transition to aging society becomes very important problem day by day. Especially for the single elderly, it is critical problem that whose vital situation. According to the data from Statistics Korea, the aging index will increase rapidly from 9.5%(2006) to 14.3%(2018) and 20.8%(2026). With this trend, the number of single aged person is increases too.

The emergency monitoring system will be the solution of these problems so we started this development. So we proposed a monitoring system that alarming the emergent status of the elderly who live alone in their home. They will use compact mobile devices to monitor their vital signals such as

SpO2 from PPG sensor and activities from accelerometer.

And the second, the mobile device which gets vital signals have features of small size and energy efficiency.

2 SYSTEM OVERVIEW

2.1 Emergency Monitoring System

Fig. 1 shows the overall system diagram of emergency system. The device module acquires vital signs from several sensors and sends data to local monitoring site or SMS server using local wireless network and cellular network appropriately. And the SMS server decides the situation and send short message to the emergency center and/or to a family member of single elderly. After this stage, the operation will depend on Emergency center or hospital.

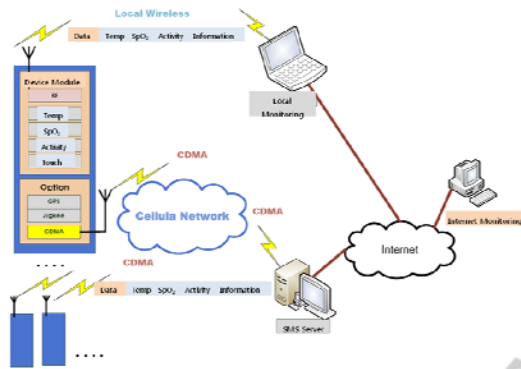

Figure 1: Overall system diagram of Emergency monitoring system.

2.2 Device Module

A device module may be attached to an ankle or wrist. The key points are size/weight and battery life. We apply several sensors to this device module which are acceleration, touch, temperature, heart rate and SpO₂ sensors.

Fig. 2 shows a block diagram of our device module. The microcontroller controls the major function of the device, and optional functions such as GPS, ZigBee, serial communication and CDMA. At this time, we use our own protocol for wireless communication between the device and base station for tests. Accelerometer for sensing activities, temperature sensor and touch sensor are located inside the device. PPG sensor for pulse oximetry is connected via serial port.

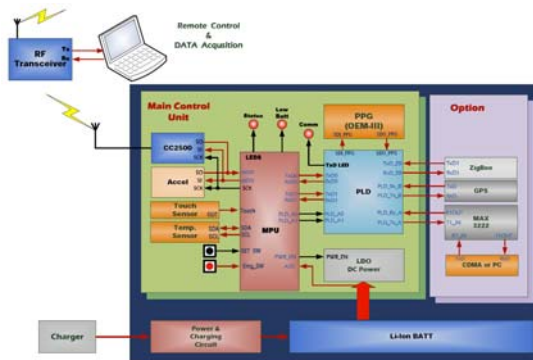

Figure 2: A block diagram of the device module.

Table 1 describes the specification of the device module. Specifications have several terms. Small size, light weight, various communication tools and acquire various vital signals such as SpO₂, activity, body temperature and touch sensor for wearing detection. Current consumption is maximum 180mA to minimum 15mA at standby state. We use the

lithium-polymer battery that has 1200mA capacity. And we prepared GPS function optionally.

Table 1: The Device Module Specification.

Term	Specification
Size mm (W x H x t)	45 x 90 x 15
Weight	96g(with battery, without CDMA module)
Communication	ZigBee, CDMA IS-95A,95B, 2.4GHz RF, RS-232
Vital Signals	SpO₂ breath, heart rate, blood O ₂ saturation Activity 3-axis accelerometer, Max.Range ±8g, 50Hz ISP comm. Body Temp. 0.2°C I2 Ccommunication
Sensing	Touch sensor for wearing detection
Current consumption	180mA(MAX) 15mA(waiting)
Battery	Litium polymer 3.7V/1200mAh, 80 hours waiting
Charge	3.7V TTA standard cahrger
GPS	2dRMS 10m or lower
Data Transfer Rate	9,600bps(Max. 38,400bps)
Number of connections	Normal: 1 time/20min, Emergency: 1 time/10sec

Fig. 3, 4 shows the internal algorithm of our device module. When power is 'ON', the status of each sensor is checked and stored.

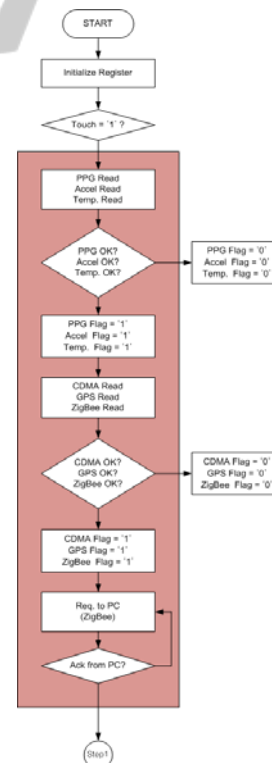

Figure 3: The internal operation algorithm of device module.

The device module is composed of three sensors which are body temperature, accelerometer and PPG sensor. There is no ECG sensor, instead we will derive the heart rate using PPG.

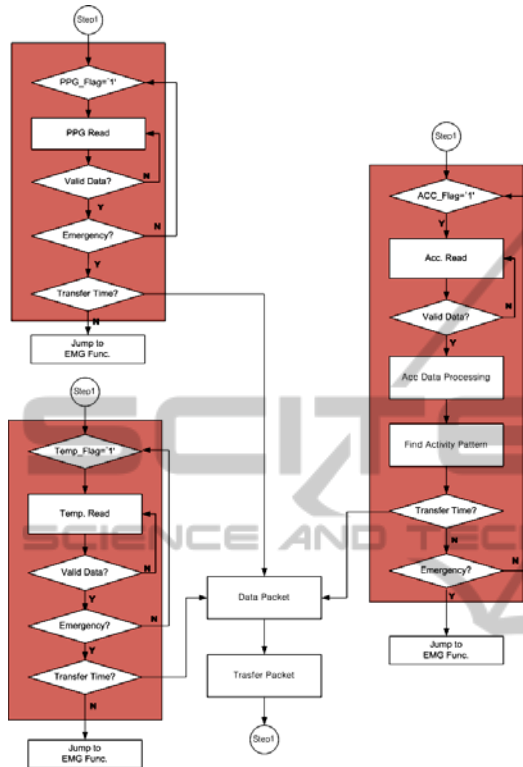

Figure 4: The internal algorithm of device module.

2.3 System Operation

The mobile device acquires vital signals. And the mobile device optionally pre-processes the raw data. Then, the mobile device sends data to Server. The server post-process and decide the final state. If the state is decided to emergent, the server send short message to the emergency center and a family member of single elderly.

When the device module detects an abnormal status, it sends data to the message server using wireless network. The message server finally decides the situation and if emergent case the server send a short message to the emergency center and family. Table II shows an example of message format. It contains a header, name, address, symptoms and event time.

Table 2: Short Message from message server to emergency center.

contents	header	name (age)	address	Symtom1	Symptom2	time	rsv
Byte	6	10	32	9	9	9	5
message	[EM]	Hong (72)	388-1, PunaNap-dong	Increase HR	Increase Temp.	23:15:37	RSV

3 RESULT

We made a prototype of the device module. Fig. 5 shows our prototype. It shows a main module and optional module for GPS and Bluetooth function.



Figure 5: A prototype of the device module.

Fig. 6 shows the wearing photograph. The ankle is just a case of possible position. With the test, we can wear on wrist or waist.



Figure 6: Wearing on ankle.

We tested the function of our device module in laboratory and Fig. 7 shows the recorded data of light walking.

We have tested in several situations. While

wearing on the forearm, the first three data show activities from accelerometer. The fourth is SpO2 from PPG sensor. The fifth is heart rate but not available yet.

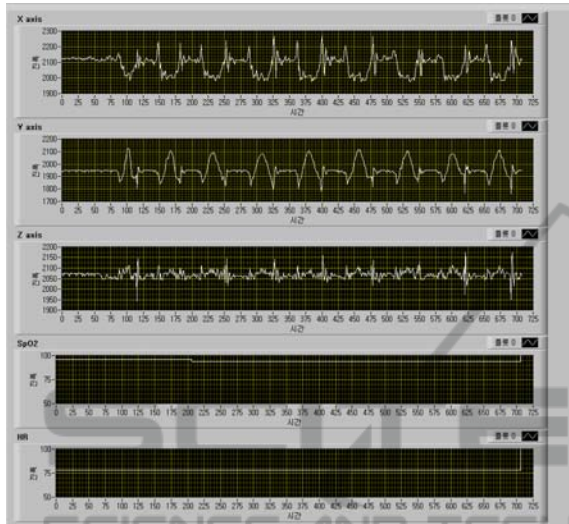

Figure 7: Data from the device module when light walking.

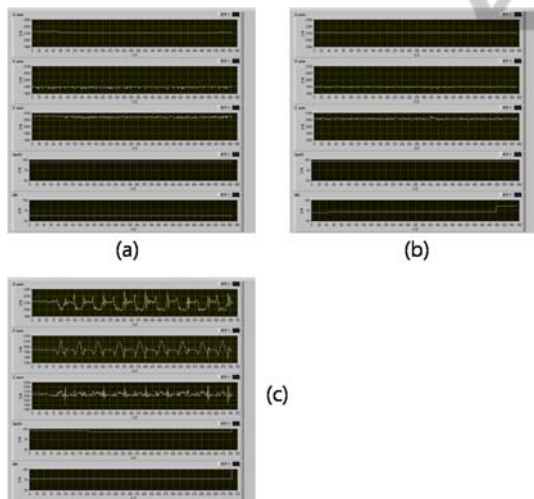

Figure 8: Waveforms of various situations; (a) Standing.

Fig. 9 shows waveforms according variable situations. The feature extraction will be our further works.

Fig. 10 shows a short message on the cellular phone of emergency center or a member of family. The message indicates ‘decreasing breath and no motion, so emergent status’.

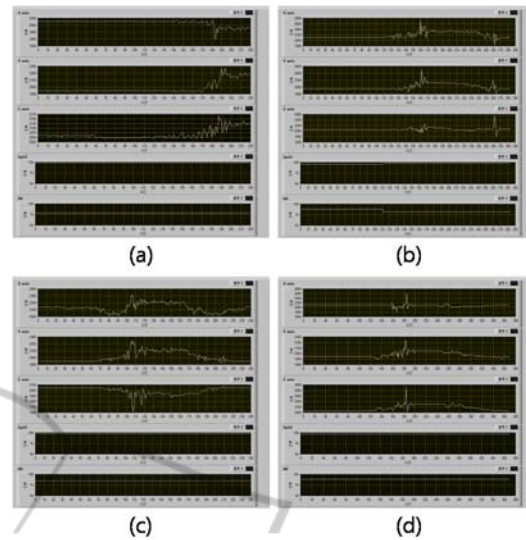

Figure 9: Feature extraction by variable situation; (a) Forward falling, (b) Backward falling, (c) Left falling, (d) Right falling.



Figure 10: Short message on cellular (Message says, [Emergency] Name(Age)/ Address/ Lower Breath rate/Reduce motion/Time)

4 DISCUSSION

We are developing the emergency monitoring system and small device module which is wearable on wrist or ankle. During 2 years development schedule, we are going one year schedule. We produced a prototype device module and built monitoring system. There are several problems to solve. One is the physical size and weight. It is very important because the main users may be the aged persons. And the battery life is another problem to solve. We are investigating carefully the benefits between weight and battery life of the device module.

Our ideas are focused on reliability and easy usage. Single elderly falls danger at home than outside. There are many persons outside to give help. So they will be less danger than home. So we can concentrate

our efforts on home area network. The other important things are minimization of complexity and simplifying situations. We may just alert to emergency center and/or family member. Further proper actions must depend on human being not on devices.

Finally we can not pass over the economic viewpoints. Cheaper, lighter, easier to using the device should be considered. Maybe, the support of government or welfare foundation will be helpful.

5 FUTURE WORKS

We are developing a cheaper, smaller PPG module as a vital sign sensor. We need pre-processing algorithm to extract several features. We also must solve the problem wearing on where and should minimize the energy consumption of sensor module. At the system operation stage, post-processing is very important to judge proper state of a person whether emergent or not. And we should refine data communication protocol and short messages. There still remain problems to solve. Policy consideration must be solved and individual privacy is another problem to consider.

ACKNOWLEDGEMENTS

This project is performed with the support of 'Small and Medium Business Administration, Korea'

REFERENCES

- Amr Amin Hafez et. al., Design of a low-power ZigBee receiver front-end for wireless sensors, *Micro Electronics Journal*.(in progress)
- Giuseppe Anastasi, Marco Conti, Mario Di Francesco, Andrea Passarell, Energy conservation in wireless sensor networks: A survey, *Ad Hoc Networks* 7 (2009) 537-568
- Mathieu Hautefeuille et. al., Miniaturized multi-MEMS sensor development, *Microelectronics Reliability* 49 (2009) 621-626
- P. Mendoza, P. Gonzalez, B. Villanueva, E. Haltiwanger, H. Nazeran "A Web-based Vital Sign Telemonitor and Recorder for Telemedicine Applications", in Proceedings of the 26th Annual International Conference of the IEEE EMBS San Francisco, CA, USA, September 1-5, 2004, pp. 2196-2199.
- Aleksandar Milenkovic et. al., Wireless sensor networks for personal health monitoring: Issues and an implementation, *Computer Communications* 29, 2006, pp. 2511-2533
- David Evans et. al., Vital signs in hospital patients: a systematic review, *International Journal of Nursing Studies* 38, 2001, pp. 643-650
- Hak Jong Lee et. al., Ubiquitous healthcare service using Zigbee and mobile phone for elderly patients, *International Journal of Medical Informatics* 78, 2009, pp. 193-198
- M. Palikonda et. al., Sensor grid applications in patient monitoring, *Future Generation Computer Systems* 26, 2010, pp. 569-575
- A. Marco et. al., Location-based services for elderly and disabled people, *Computer Communications* 31, 2008, pp. 1055-1066
- Francis E. H. et. al, MEMS-Wear biomonitoring system for remote vital signs monitoring, *Journal of the Franklin Institute* 346 2009, pp. 531-542