

# EXECUTION MEASUREMENT-DRIVEN CONTINUOUS IMPROVEMENT OF BUSINESS PROCESSES IMPLEMENTED BY SERVICES

Andrea Delgado

*Computer Science Institute, Faculty of Engineering, University of the Republica, Montevideo, Uruguay*

Barbara Weber

*Computer Science Institute, Quality Engineering Research Group, University of Innsbruck, Innsbruck, Austria*

Francisco Ruiz, Ignacio García-Rodríguez de Guzmán

*Alarcos Research Group, Technologies and IS Department, University of Castilla-La Mancha, Ciudad Real, Spain*

**Keywords:** Business Process Management (BPM), Service Oriented Computing (SOC), Business process execution measures, Continuous business process improvement.

**Abstract:** Continuous improvement of business processes is becoming increasingly important for organizations that need to maintain and improve their business in the current context, and to that end the continuous incorporation of changes to improve it is a key issue. However, an organization that has not defined how to measure and analyze the execution of its business processes is unlikely to have real and reliable information to introduce these changes. Nor will it easily achieve the goals set for the improvement effort that has been set out. MINERVA framework provides a comprehensive guide for the continuous improvement of business processes implemented by services and following principles of model driven development. Among other elements it defines a Business Process Continuous Improvement Process (BPCIP) and a Business Process Execution Measurement Model (BPEMM). In this paper we present the BPCIP and the BPEMM to first identify the business goals defined for business processes; second, to select the appropriate execution measures to be implemented and collect the associated execution information; third, to analyze and evaluate this information, identifying improvement opportunities, and fourth, to integrate these improvements into business processes in a systematic way to achieve the specific improvement results.

## 1 INTRODUCTION

The Business Process Management (BPM) (Weske, 2007) (van der Aalst et al., 2003) (Smith et al, 2003) paradigm is being used increasingly in organizations to manage their business. The explicit modelling of business processes (i.e. using BPMN (OMG,2008a)) together with information regarding its execution constitute the main elements with which to compare the functioning of the organization as it moves towards achieving its business goals. The measurement of their business process execution is a key issue to be able to analyze its operation to see if business goals are being achieved. If they are not, the idea is to find improvement opportunities that

would modify the business process so that it could reach the goals defined.

MINERVA framework (Delgado et.al, 2009b) (Delgado et. al, 2010c) provides support for the business process lifecycle (Weske, 2007) and its continuous improvement, implementing them with services (Papazoglou et al, 2007) using model driven development (Mellor et. al, 2003). It is made up of three dimensions: conceptual (Delgado et.al, 2010a), methodological (Delgado et.al, 2009a) (Delgado et.al, 2010d) and tools (Delgado et.al, 2010b). It thereby integrates concepts, models, methodologies and processes for both development and improvement, and tools. In this article we extend the definition of MINERVA describing the Business

Process Continuous Improvement Process (BPCIP) for guiding the improvement effort and the Business Process Execution Measurement Model (BPEMM) to guide the selection, implementation, collection, analysis and evaluation of execution measures for Business Process (BP) implemented by services.

The rest of the article is organized as follows: in Section 2 the BPCIP is presented detailing its phases and activities. Section 3 describes the BPEMM along with an example of its use. Section 4 sets out related work and finally in Section 5 conclusions and future work are discussed.

## 2 BP CONTINUOUS IMPROVEMENT PROCESS

The Business Process Continuous Improvement Process (BPCIP) is defined in the methodological dimension of MINERVA, and its main objective is to guide the improvement effort in the organization. It integrates the phases of the business process lifecycle in (Weske, 2007) and those from the continuous improvement process PmCOMPETISOFT in (Pino et.al, 2009). The measures defined in the Business Process Execution Measurement Model (BPEMM) are used to relate the BP execution to the organization's business goals explicitly, as well as to implement, register and assess the associated data. In Section 3 BPEMM will be described in detail.

A complete execution cycle through the MINERVA framework begins with modeling a new BP or redesigning an existing one in BPMN, whose

execution is then measured and evaluated, aiming to identify improvement opportunities. BPMN was selected for many reasons mainly as it is an OMG standard widely adopted and MINERVA is a standardized framework. These improvements can then be fed back into the business process following a systematic approach based on the continuous improvement process defined. Finally, the measures of the new version of the business process comprising the improvements made are compared with the previous version, to evaluate the results of the changes carried out. The general framework of BPCIP is shown in Figure 1.

On the left side of Figure 1 the business process lifecycle (bottom left circle) defines four phases: *Design & Analysis*, *Configuration*, *Enactment* and *Evaluation*. For each of these phases we show explicitly the corresponding measurement activities in which the BPEMM is used (outer four arrowed circle). In addition, the arrow from Design&Analysis to Configuration indicates the use of the Business Process Service Oriented Methodology (BPSOM) to guide the implementation of business processes with services. On the right side the continuous improvement process (upper right circle) defines five phases: *Initiating the cycle*, *Diagnosing processes*, *Formulating improvements*, *Executing improvements* and *Revising the cycle*. Three arrows indicate the navigation from one cycle to another: from the *Executing improvements* phase of the improvement process to the *Design &Analysis* or the *Configuration* phases to re-enter BP lifecycle, and from the *Evaluation* phase to the *Revising the cycle* phase to return to the improvement process.

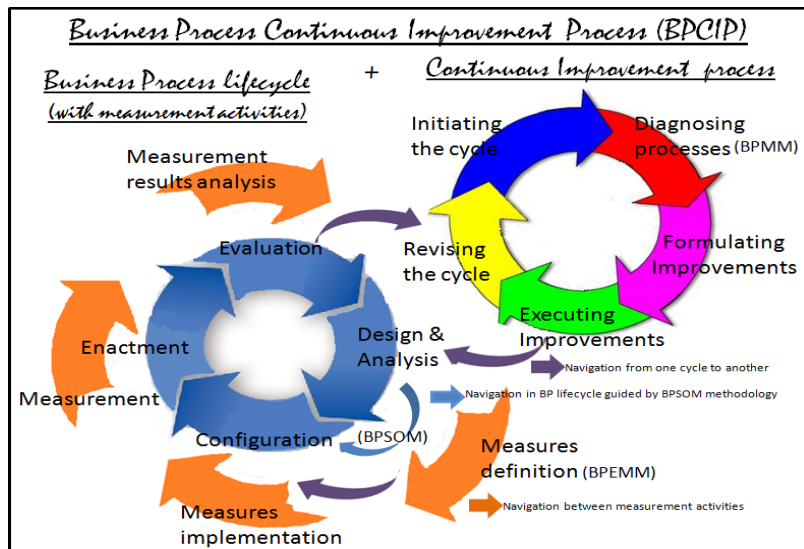

Figure 1: MINERVA Business Process Continuous Improvement Process (BPCIP).

## 2.1 Process Phases and Activities

This section sets out the particular phases and the activities in executing a complete BPCIP cycle of MINERVA framework, as shown in Figure 1.

### 2.1.1 Design & Analysis

The cycle begins with the design and specification of a business process by means of BPMN models as part of the *Design & Analysis* phase. These models are then validated through simulation or analytical techniques to determine their relevance to the specified business goals, or to evaluate different design options for it. Moreover, to assess quality characteristics of the model created (i.e., complexity) as well as to detect potential problems in early stages, design measures not presented here can be used (Rolón et. al, 2006) (Cardoso, 2006) (Mendling, 2008) (Sánchez González et. al, 2010). Finally, the BPEMM of MINERVA is used to select execution measures according both with the business objectives defined for the BP and the business strategy of the organization.



Figure 2: Main activities in Design&Analysis phase.

### 2.1.2 Configuration

In the *Configuration phase* the BPs are implemented by services with model driven development, guided by the BPSOM methodology (Delgado et.al, 2009a). BPSOM defines the disciplines Business Modeling, Services Design and Implementation with activities, input and output deliverables, and roles needed to carry out the service development starting from the BP that has been defined. In addition, QVT (OMG, 2008b) transformations are defined and executed to generate SoaML (OMG, 2009) service models from BPMN models. This phase is also concerned with the implementation of the execution measures selected to be integrated directly into the process engine or into software systems, in the form of execution logs to register the information needed.

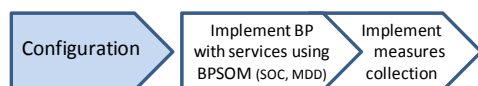

Figure 3: Main activities in Configuration phase.

### 2.1.3 Enactment

In the *Enactment phase* the BPs are executed in an

appropriate process engine according to their implementation (BPEL/XPDL), from which to invoke the services realizing BP activities, sub-process or even the complete BP. The execution measures defined and implemented are collected as BP cases (instances) are executed, registering the events and information needed for the execution measures to be calculated later.

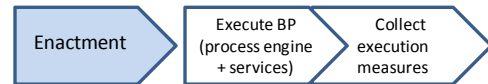

Figure 4: Main activities in Enactment phase.

### 2.1.4 Evaluation

The BP execution is then assessed in the *Evaluation phase* analyzing the measurement results. For this to be done, the execution measures are calculated on the basis of the information registered in the execution logs using the Process Mining (van der Aalst et al, 2007) framework ProM (ProM). By means of several plug-ins ProM allows different views of the associated information to be analyzed. Using the analysis performed it is possible to identify improvement opportunities for redesigning the BP, which can be related to the BP modelling level as well as to the software realizing the BP (implemented services), such as bottlenecks in the BP or service execution delays. For the redesign of the BP several existing approaches can be used (Reijers, 2003) (Maruster, 2009) (Netjes, 2010).



Figure 5: Main activities in Evaluation phase.

### 2.1.5 Initiating the Cycle

Once the improvement opportunities have been identified, the continuous improvement process to carry out the improvement effort is undertaken, executing the corresponding phases. This implies the introduction of the improvements in a systematic way in order to assure the achievement of the results specified for the improvement of some or several BP characteristics. In the *Initiating the cycle* phase the improvements to be included in this iteration are established, including the BPs and the characteristics to be improved, as well as the results expected after the introduction of the improvements that have been defined. This can also lead to a revision of the execution measures chosen.

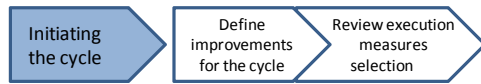

Figure 6: Main activities in Initiating the cycle.

### 2.1.6 Diagnosing Processes

In the *Diagnosing processes* phase other aspects of the BP definition (i.e., management) can be assessed using the OMG Business Process Maturity Model (BPMM) (OMG, 2008c). This standard which follows the format defined by the software maturity models (CMM, CMMI) includes several Process Areas and defined Key Activities that when performed, allows the BP to gain maturity by evolving through the model's five maturity levels. Based on this diagnosis new improvement opportunities for the BP can be found, which can be included in this iteration. For a description of the BPMM and BP measuring activities we refer the reader to (Sanchez González et al, 2009).



Figure 7: Main activities in Diagnosing processes.

### 2.1.7 Formulating Improvements

The *Formulating improvements* phase aims to define how (by doing what) the selected improvements for this iteration will be introduced. To do so, the changes have to be defined specifically, i.e., if an activity in a BP has been identified as a bottleneck and its execution time should be improved, it could be specified that for this activity several redesigns must be evaluated to obtain better results. The same applies if the problem detected involves the execution of services which realizes the BP. In any case, the improvement to be made will be set out in detail in the associated improvement document.

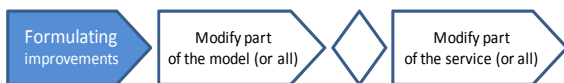

Figure 8: Main activities in Formulating improvements.

### 2.1.8 Executing Improvements

In the *Executing improvements* phase the BP lifecycle is re-entered exactly where the improvements have to be made. If the improvement refers to the BP model then the lifecycle is re-entered in the *Design & Analysis phase*, where parts of the BP model or its entirety will be redesigned to introduce the improvements. Afterwards the whole

BP lifecycle will again be executed with the new version of the BP. The existing traceability between the BPMN BP models and its implementation with services, will allow the identification of the impact of the changes in related services and/or other software artefacts in the Configuration phase.

On the other hand, improvement might only refer to the implementation of the BP (i.e., the BP model will not be changed but only the software realizing the BP). In that case the BP lifecycle will be re-entered in the *Configuration phase*, to implement changes in the services. Once the BP model and/or the services realizing it are modified, along with the implementation of the execution measures to be collected for the new version of the BP, this new version of the BP is executed registering the associated data in the specific execution logs. Finally, the defined activities are executed in the *Evaluation phase*, along with a comparison between measurement results from the new version of the BP and the previous version used as the basis for improvements. This comparison will also allow assessing if the goals set out for the improvement that has been brought in have been achieved.

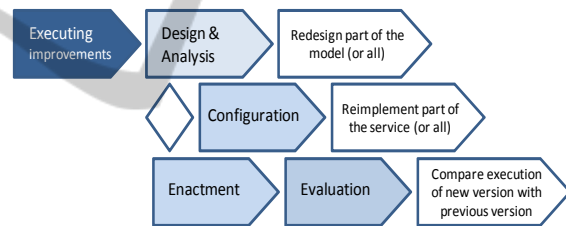

Figure 9: Main activities in Executing improvements.

### 2.1.9 Revising the Cycle

In the *Revising the cycle* phase the data registered about the execution of the continuous improvement process itself is analyzed, to identify improvement opportunities in the improvement process also.



Figure 10: Main activities in Revising the cycle.

## 3 BP EXECUTION MEASUREMENT MODEL

Measurement of BP execution to analyze the achievement of business goals as well as to detect improvement opportunities is a key aspect in

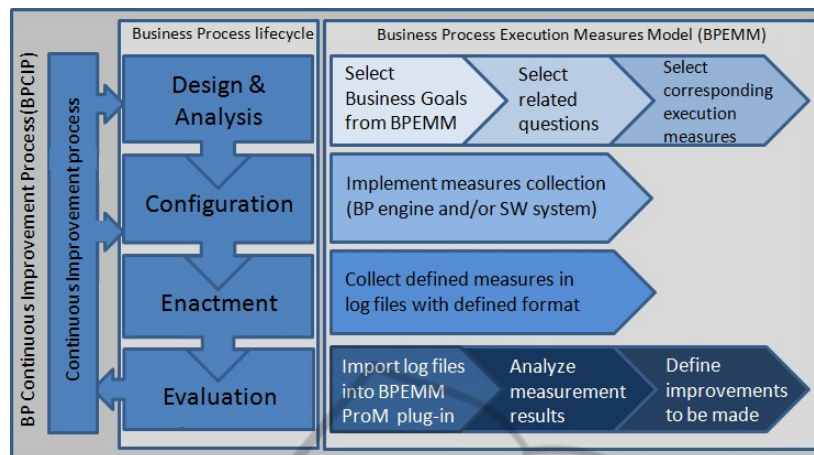

Figure 11: Detailed measurement activities from BPEMM and its use in the BPCIP context.

MINERVA framework. Although the execution measurement activities are not new, it is the BPEMM model proposal. Its goal is to define a set of pre-defined measures for BP execution based on services, to support the improvement effort, relating business goals for the BP to its real execution, and helping in finding improvement opportunities. In Figure 11 the relation between BPCIP and BPEMM is shown, along with the BPEMM activities.

### 3.1 BPEMM Definition

BPEMM aims to help in relating business strategy and goals to business process implementation and execution, thus facilitating the selection of predefined execution measures for each business goal. BPEMM definition focuses on organizations which implement their BPs with services, proposing a set of execution measures from three defined views: generic BP execution (i.e., generic and domain specific measures for domains such as medical, software, production), focus on lean philosophy (e.g., eliminating waste and encouraging optimization), and services execution (i.e., for execution of services realizing the BP). These views were defined to cover as much information as possible to be able to get accurate knowledge from the execution logs of the BP, and then focus BP improvements on the specific parts of the BP. In addition to the views the dimensions defined by the “Devil’s quadrant” (Brand&Van der Kolk, 1995) (Reijers; 2003): time, cost, flexibility and quality, were taken into account. These dimensions refer to the trade-off that has to be taken into account when designing or redesigning a BP. For example, adding activities to improve the quality of the BP can have a negative impact on its performance. It is therefore

important to collect information on the BP execution for each dimension, to analyze the improvements.

For the definition of the execution measures of the model, we used the Goal, Question, Metrics (GQM) paradigm (Basili, 1992) which is based on the idea that an organization must first specify its goals if it is to measure in a meaningful way what the organization does. It provides a systematic approach to establish and assess a set of operational goals based on measurement. It integrates goals with process models, products, resources and different perspectives, depending on the needs of the organization and project. Initially defined to evaluate defects in software projects, its use has been expanded to improvement efforts in software organizations. As our proposal includes a continuous improvement process that also comes from the software area, the use of GQM to define BPEMM is set in the same direction. BPEMM measures are then defined by three main elements:

- Goal: it is defined for the organization, section, project or process, from various points of view with respect to different models.
- Question: it is used to describe how each goal will be evaluated from the point of view of a quality characteristic.
- Metric: a set of data associated with each question to be answered quantitatively. Measures can be objective or subjective.

For the specification of BPEMM execution measures we use the Software Measurement Ontology (SMO) (García et al, 2005). The SMO defines, among other concepts, different types of measures: base and derived measures and indicators, which are calculated by a measurement approach. In addition to the specification of GQM elements for each view and dimension in natural language, we

model the execution measures and associated concepts in a graphical way. To do that, we use the SMTTool (Mora et al, 2008) which implements SMO. It provides a quick overview of the measures set out to satisfy the information needs of the organization, helping in the communication with stakeholders.

### 3.1.1 Views, Dimensions and Measures

The execution measures views defined in BPEMM allow the measures to be organized according to three relevant perspectives. In the first view defined, i.e., generic BP execution, the measures are related to BP characteristics that are common to all processes regardless of the associated domain, such as their duration or the duration of their activities, the associated cost, the roles involved, etc. However, some of these generic measures have to be instantiated for the BP domain, for example when they involve label definitions such as “successful branch”, where activities comprising the branch have to be identified for each BP. Generally, these kinds of measures are specified as Key Performance Indicators (KPIs) by the business management area.

The “Devils quadrant” dimensions are used to group these measures. The definition of measures for a BP is also defined in a three-level hierarchy. At the third level measures for the execution of each activity are registered. At the second level these measures are combined to calculate the BP case measures. Finally, in the first level case measures are combined to calculate the measures for the BP

definition (e.g., averages, percentages, etc.).

We present as an example of this view of BPEMM, some execution measures defined in the Time dimension related to the BP performance, i.e., its Throughput Time (TT) or Cycle Time. This is defined, for a BP case (instance) as the total time incurred from the moment in which the case is initiated until it is completed (Reijers, 2003; Laguna et al, 2005). Several different times are defined to calculate time measures such as: enable, start, change, suspension, queue, processing (or working), service, setup, waiting and completion time, for activities and cases (Reijers, 2003) (zur Muehlen, 2004) (Laguna et al, 2005) (Netjes, 2010). From these we used as base measures for an activity, the enabled time (i.e., when an activity becomes available for execution), start time (i.e., when it actually starts its execution) and completion time (i.e., when an activity completes its execution). Based on these the derived measures and indicators are calculated as shown in Table 1. The explanation of the basic concepts about time measures defined for an activity and a BP case is shown in Figure 12. In addition to throughput time (TT), the generic execution measures view defines other measures for this and the rest of the dimensions of the Devil’s quadrangle, which are not presented here.

As can be seen in Table 1 measures have been defined for the Goal “Minimize the TT of the BP” at three different levels: activity, BP case and set of all BP cases. By analyzing the measurement

Table 1: Generic BP execution view, time dimension measures sub-set.

Goal	Purpose Issue Object	Minimize the throughput time (TT) of the BP
Question	Q1	which is the actual throughput time of the BP
Metrics	M1 (base) M2 (base) M3 (base) M4 (derived) M5 (derived) M6 (derived) M7 (derived) M8 (derived) M9 (indicator)  M10 (indicator)  M11 (indicator)  M12 (indicator)  M13 (indicator)  M14 (indicator)  M15 (indicator)	Enabled time of an Activity (ET) Start time of an Activity (ST) Completion time of an Activity (CT) Working time of an Activity ( $AWoT = CT - ST$ ) Waiting time of an Activity ( $AWaT = ST - ET$ ) Total Working time of a BP case ( $TWoT = \sum (AWoT)$ ) Total Waiting time of a BP case ( $TWaT = \sum (AWaT)$ ) Throughput Time of a BP case ( $BPTT = TWoT + TWaT$ ) Activity Working time vs. Activity Waiting time index ( $ATI = AWaT/AWoT$ ) Decision criteria = Index DC: R1: $0 \leq TTI \leq L1 = "LOW" \rightarrow GREEN$ ; R2: $L1 \leq TTI < L2 = "MEDIUM" \rightarrow YELLOW$ ; R3: $L2 \leq TTI = "HIGH" \rightarrow RED$ Total BP Working time vs. Total BP Waiting time index ( $TTI = TWaT/TWoT$ ) Decision criteria = Index DC. Percentage of total BP Working time in total BP TT ( $PWoT = TWoT * 100 / BPTT$ ) Decision criteria = Percentage DC: R1: $0 \leq TTI < L1 = "LOW" \rightarrow RED$ ; R2: $L1 \leq TTI < L2 = "MEDIUM" \rightarrow YELLOW$ ; R3: $L2 \leq TTI \leq 100 = "HIGH" \rightarrow GREEN$ Percentage of Total BP Waiting time in Total BP TT ( $PWaT = TWaT * 100 / BPTT$ ) Decision criteria = Inverse Percentage DC (GREEN, YELLOW, RED) Average BP Throughput Time for all BP cases ( $ABPTT = \sum BPTT / \text{Total BP cases}$ ) Decision criteria = Inverse Percentage DC (GREEN, YELLOW, RED) Average BP total Working time for all BP cases ( $ABPTWoT = \sum TWoT / \text{Total BP cases}$ ) Decision criteria = Percentage DC Average BP total Waiting time for all BP cases ( $ABPTWaT = \sum TWaT / \text{Total BP cases}$ ) Decision criteria = Inverse Percentage DC (GREEN, YELLOW, RED)

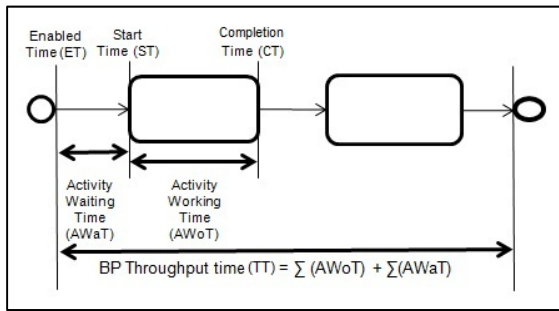

Figure 12: Time concepts definition for BP execution.

results for each level, improvement opportunities can be detected from global BP execution measures (i.e., average, percentage) to the corresponding activities or BP parts that have to be changed to improve the TT of the BP. For indicators decision criteria have to be defined, i.e., the different ranks to which the measurement result can belong. To define the ranks we use labels that have to be changed to actual numbers for each BP and organization when selecting the execution measures (e.g.  $0 \leq \text{Measurement result} \leq L1$ ). This allows the ranks to be flexible enough to be used in different contexts using different numbers instead of the labels.

Associated with the meaning of the ranks defined, we also use semaphores as supported in ProM. The semaphores show the meaning of the ranks by means of colors, where Green means “OK”, Yellow means “Warning” and Red means “Problems”. In Figure 13 some of the measures

presented in Table 1 are shown graphically using the SMTool, which provides special icons for each concept defined in the SMO, its attributes, associations and restrictions defined between the ontology elements (i.e., rule for base measure, rule with figures for derived measures, rule with figures and lamp for indicators, among others).

Other goals defined in the Generic BP execution view are, among others: “Minimize the cost of the BP” and “Minimize the use of resources for the BP” both of which correspond to the cost dimension, “Maximize the BP cases ending normally” (i.e., normal completion of the instance, successful or unsuccessful, with no abortion due to errors or user cancellation) corresponding to the quality dimension, and “Maximize the BP cases ending successfully” (i.e., executing the successful branch of the BP involving the execution of defined activities, such as making and paying for the reservation of flight, room and others in a travel agency BP) corresponding to a domain specific execution measure. Table 2 shows an example of execution measures to be instantiated for domains.

The second BP execution view defined focuses on the Lean thinking philosophy, aiming to find elements in the BP that could be unnecessary or replaceable, or parts of the BP that if made as efficient as possible can lead to an optimization and improvement of the complete BP definition (Laguna et al, 2005). Lean thinking was first introduced in the Toyota Production System (TPS) and

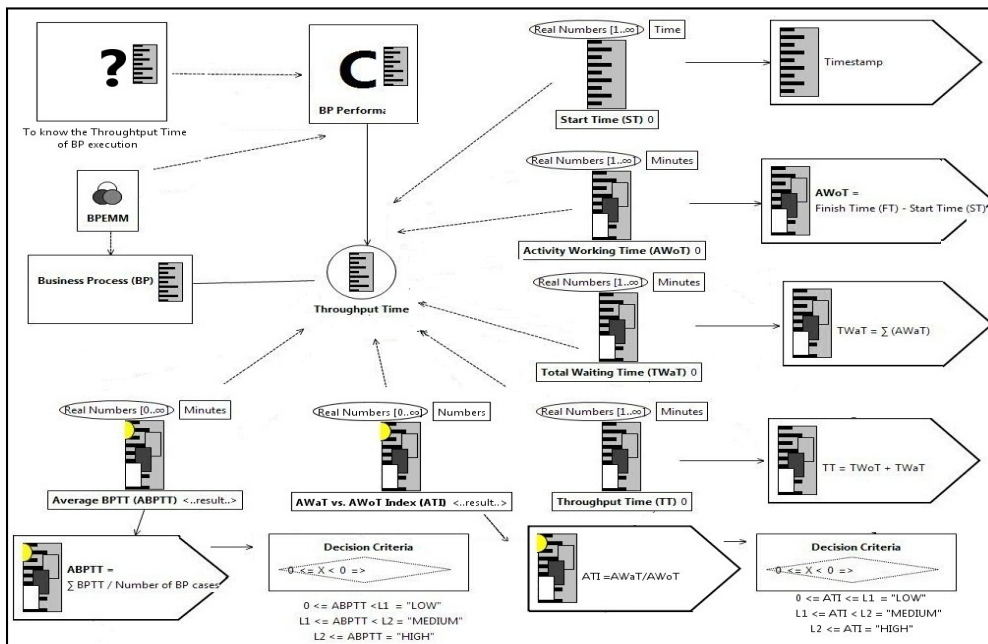

Figure 13: Some measures from Table 1 shown graphically in the SMTool (Mora et al, 2008).

Table 2: Generic BP execution view, domain specific measures sub-set.

Goal	Purpose Issue Object	Maximize the BP cases ending successfully (executing the successful branch of BP) of the BP
Question	Q1	which is the actual number of BP cases ending successfully
Metrics	M1 (base) M2 (base) M3 (derived) M4 (derived) M5 (indicator)	Successful branch execution of a BP case (SB = branch with execution of activity X) Unsuccessful branch execution of a BP case (USB = branch with execution of activity Y) Number of BP cases ending successfully (BPSB = count of SB) Number of BP cases ending unsuccessfully (BPUSB = count of USB) Percentage of BP ending successfully in total BP cases (PBPSB = BPSB*100/TCBP) Decision criteria = Percentage DC: R1: $0 \leq TTI < L1 = "LOW" \rightarrow RED$ ; R2: $L1 \leq TTI < L2 = "MEDIUM" \rightarrow YELLOW$ ; R3: $L2 \leq TTI \leq 100 = "HIGH" \rightarrow GREEN$

Table 3: Lean BP execution view measures sub-set.

Goal	Purpose Issue Object	Minimize the rework in loops of the BP
Question	Q1	which is the actual quantity of rework due to BP loops
Metrics	M1 (derived) M2 (derived) M3 (derived) M4 (derived) M5 (indicator)	Activity rework in a loop (ARL = counts the time each activity is executed in a loop) Activity Working time for the rework in a loop ( $AWoTRL = \sum (AWoTe_i)$ being $e_i$ each execution of the activity in the loop) Total Working time for the rework in a loop of the BP ( $TWoTRL = \sum (AWoTRLa_i)$ where $a_i$ represents an activity in the loop) Total Working time for rework in all loops of BP case ( $BPTWoTRL = \sum (TWoTRL_i)$ where $i_i$ represents a loop in the BP) Percentage of rework time in BP case due to loops in the total BP TT ( $PBPTWoTRL =$ $BPTWoTRL * 100 / BPTT$ ) Decision criteria = Percentage DC: R1: $0 \leq TTI < L1 = "LOW" \rightarrow GREEN$ ; R2: $L1 \leq TTI < L2 = "MEDIUM" \rightarrow YELLOW$ ; R3: $L2 \leq TTI \leq 100 = "HIGH" \rightarrow RED$

is based mainly on the identification and elimination of waste. It defines as key principles the specification of value from the customer viewpoint, the removal of waste, making valuable flow, delivering what the customer wants when it is wanted and pursuing perfection. There are seven types of waste defined: overproduction, waiting, transport, extra processing, inventory, motion and defects. These principles and waste types have been adapted to several areas other than the manufacturing sphere, such as lean software development (Poppendieck, 2002), lean information management (Hicks, 2007) and healthcare (Jimmerson et al, 2005), among other realms, thus making lean thinking usable in several BP domains. As an example the GQM for the goal “Minimize the rework in loops of the BP” is shown in Table 3, which focuses on the detection of defects on the products or services delivered by the BP.

Finally, the third view corresponding to the Services execution, aims to define measures to assess the execution of services realizing the BP. Several issues have to be taken into account to identify the most important features as regards Quality of Services (QoS) requirements specified in Services Level Agreement (SLA) (Wetzstein et al, 2008) (Cardoso et. al, 2002). To define these measures we used the Quality Attributes (QA)

concepts for non-functional requirements and the taxonomies from (O’Brien et. al, 2005) (Clements et. al, 2001) (Bass et. al., 2003) (Barbacci et. al, 1995). Services measures then include quality attributes such as: performance (i.e., response time including processing time and latency, throughput, capacity), dependability (i.e., availability, reliability), security (i.e., confidentiality, availability). Services execution measures defined for performance are related to the Generic execution measures for BP performance. They focus, however, on the automatic activities (i.e., tasks, sub-process, process) that are implemented by services, adding information about the execution of the specific software infrastructure. Table 4 presents the GQM for the Goal “Guarantee response time to L1 (i.e., label to be changed) seconds for the service”, as an example of this.

### 3.2 Example of BPEMM Use

To give an example of the use of the BPEMM in the context of the BPCIP from the MINERVA framework we present the “Patient Admission and Registration for Major Ambulatory Surgery (MAS)” business process in Figure 14. In the following we describe the possible execution of the improvement cycle based on defined measures. The organization is the “Hospital” whose business management area



Table 4: Services execution view measures sub-set.

Goal	Purpose Issue Object	Guarantee response time to L1 seconds (label to be changed) (on peak load/normal operation) for the service (implementing an activity/sub-process/process)
Question	Q1	which is the actual response time of the service
Metrics	M1 (derived) M2 (derived) M3 (derived) M4 (indicator)	Processing time of a service (SPoT = CT-ST) (idem AWoT but for the defined service) Latency time of a service (SLaT = ST - ET) (idem AWaT but for the defined service) Response Time of a service in a BP case (SRpT = SPoT + SLaT) Average service Response Time in all BP cases (ASRpT = $\sum$ SRpT/ Total services execution in all BP cases) Decision criteria = Average DC: R1: $0 \leq TTI < L1 = "LOW" \rightarrow GREEN$ ; R2: $L1 \leq TTI < L2 = "MEDIUM" \rightarrow YELLOW$ ; R3: $L2 \leq TTI \leq 100 = "HIGH" \rightarrow RED$

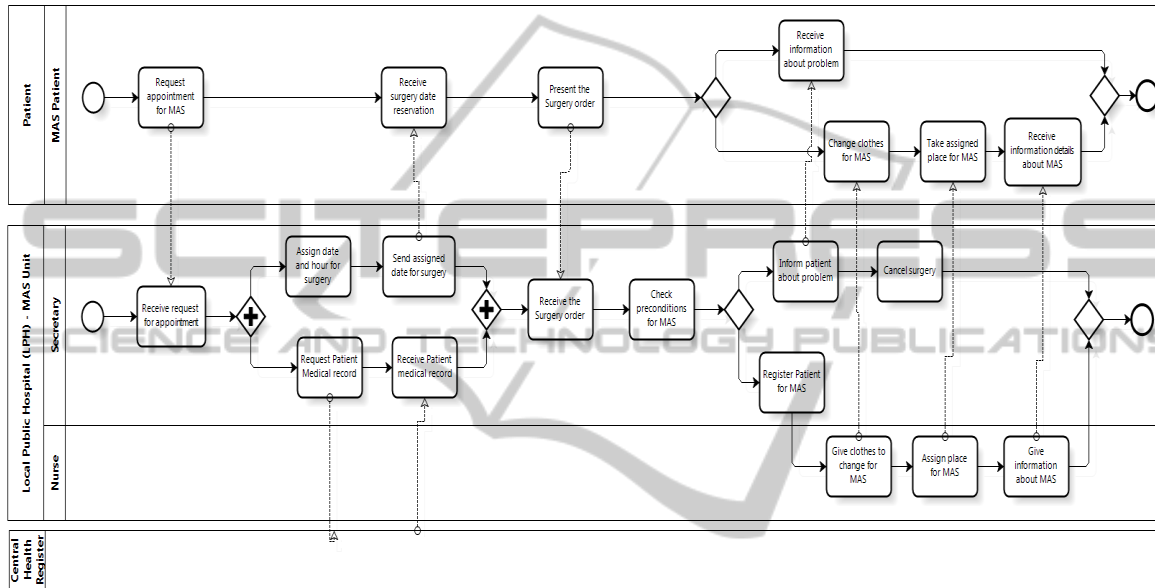

Figure 14: “Patient Admission and Registration for MAS” business process specified using BPMN.

we assumed has chosen, in the Design & Analysis phase, the set of execution measures of the Generic execution view for the time dimension and services execution measures (cf. Table 1, Table 4). Further assume that guided by the BPSOM methodology services to realize the BP have been implemented which will be externally invoked by other participants, and services have been defined to be invoked by the Hospital from other parties.

In the Configuration phase assume the collection of chosen measures is implemented in the software for BP execution, and then the defined execution information is registered in the execution logs. Based on the measures defined for calculating BP Throughput Time (TT) in BPEMM, times corresponding to base measures for BP activities have to be logged: enabled, start and finish time. Table 5 shows an example of some events related to the execution of activities simulating two BP cases. It can be seen that as defined, the specified times are registered for each activity, indicating to which event the timestamp corresponds (enabled, start,

finish). Based on this information the execution measures for the BP Throughput Time (TT) are then calculated. Other information that can be registered corresponding to other execution measures defined such as the role or person/system performing the activity is not shown in the table.

In the Evaluation phase based on the information registered in the execution logs, the defined execution measures can be calculated. Some of the measurement results can be as follows:

- Average TT (ABPTT) = 8640 minutes (6 days)
- Case max.TT(BPTT) = 21600 minutes (15 days)
- Case min. TT (BPTT) = 2880 minutes (2 days)

The Average TT for all BP case executions is 6 days instead of 4 days as defined by the business area for performing the BP. The maximum value of 15 days shows that there are cases which take significantly longer than 4 days. As these values are not the expected ones, other measurement results can be evaluated for BP case executions and for key activities of the BP. The M14 indicator of Average

Table 5: Example of execution logs information.

Case	Activity	Timestamp	Event
Case 1	Receive request MAS	10-01-2010: 09:30	Enabled
Case 1	Receive request MAS	10-01-2010: 09:30	Start
Case 1	Receive request MAS	10-01-2010: 10:00	Completed
Case 2	Receive request MAS	10-01-2010: 09:30	Enabled
Case 2	Receive request MAS	10-01-2010: 09:35	Start
Case 2	Receive request MAS	10-01-2010: 10:15	Completed
Case 1	Assign date for MAS	10-01-2010: 10:00	Enabled
Case 2	Assign date for MAS	11-01-2010: 10:15	Enabled
Case 2	Assign date for MAS	13-01-2010: 12:15	Start
Case 2	Assign date for MAS	13-01-2010: 12:45	Completed
Case 1	Assign date for MAS	13-01-2010: 12:45	Start
Case 1	Assign date for MAS	13-01-2010: 13:00	Completed
Case 1	Send assigned date for MAS	13-01-2010: 13:00	Enabled
Case 1	Send assigned date for MAS	13-01-2010: 13:02	Start
Case 1	Send assigned date for MAS	13-01-2010: 13:05	Completed
Case 2	Send assigned date for MAS	13-01-2010: 12:45	Enabled
Case 2	Send assigned date for MAS	13-01-2010: 12:46	Start
Case 2	Send assigned date for MAS	13-01-2010: 12:50	Completed

BP Working time (ABPTWoT) as well as the M10 indicator of the Index (TTI) between BP Total Working time vs. Total Waiting time, which are not shown due to space reasons, show that the TT of the BP is increased by waiting times in the execution of some activities. After analyzing the values for several BP cases, the M9 indicator of the index (ATI) between Working time and Waiting time of

the activity “Assign date and hour for the surgery” is found to be in the rank “High” in 90%, i.e., the activity’s waiting time is unreasonably high compared to its working time. Then, the origin of the BP execution problem is located in the activity mentioned, so an improvement effort with focus on this activity is initiated, to redesign the BP model.

The activities defined in the improvement process have to be performed then, to specify the improvements to be integrated in the cycle, how to integrate them into the BP, and finally to execute the particular improvements re-entering the BP lifecycle again. In this case, re-entry is in the Design & Analysis phase as the BP model has to be redesigned. To do so, there are approaches that propose different options (Reijers, 2003) (Maruster, 2009) (Netjes, 2010). In the example, one option could be to combine the activity with the one called “Send assigned date for surgery” in an activity of higher granularity, which performs both tasks automatically, thus eliminating the manual intervention in the first one. Figure 15 shows the two BP versions before and after the improvement.

Redesign options can be evaluated by means of analytical or simulation techniques. After selecting a redesign, a new version of the BP is generated continuing with it execution up to the calculation of the associated execution measures. Finally, the measures results for the new BP version executed are compared to the ones from the previous BP version, to assess whether the defined goals have been achieved with the introduced improvement. In the example the goal is to reduce the BP Average Throughput Time (TT) from 6 to 4 days.

#### 4 RELATED WORK

Regarding BP execution measurement our definitions are based on the works on (Reijers, 2003)

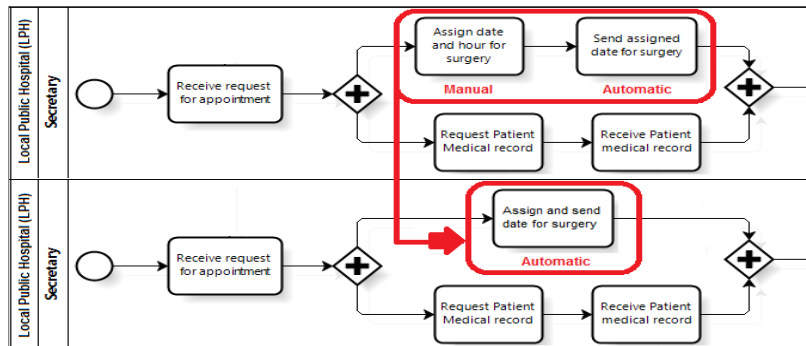

Figure 15: Versions Comparison for “Patient Admission and Registration for MAS”.

(Laguna et. al, 2005) (zur Muehlen, 2004) (van der Aalst et. al, 2007) where several concepts and measures, are presented and analyzed. Process Mining (van der Aalst, 2007) uses execution logs information to help finding BP models from BP execution, checking conformance between BP models and its execution, and extending BP models with execution information. Analytical techniques are used in (Reijers, 2003) (Laguna et. al, 2005) to analyze and predict BP performance and other BP characteristics, and simulation is also used in (Laguna et. al., 2005) (Netjes, 2010). To redesign BP models based on improvement opportunities found several options are proposed in (Reijers, 2003) (Netjes, 2010). Using a data warehouse is proposed in (zur Muehlen, 2004) to store, analyze and evaluate BP execution. Design measures defined in (Rolón et. al, 2006) (Mendling, 2008), (Sánchez González et. al, 2010) are complementary to ours and can be used to find improvements opportunities in earlier stages of the BP lifecycle.

Several proposals exist from the business area but they focus mostly on the definition of Key Performance Indicators (KPIs) related to the flow and domain of the BP, not taking explicitly into account the infrastructure which realizes it. Some tools from the software area such as ProM (ProM) has a plug-in to make basic performance analysis based on measures defined. ARIS (ARIS) has a Process Performance Manager (PPM) which also provides insight into performance and other BP execution measures, which have to be defined. Other techniques like Balance Scorecard (Kaplan et. al, 1992) are proposed and used by the business area to align the BP with the strategic goals of the organization and to define the associated measures, a comparison with GQM can be seen in (Buglione et. al, 2000). Several tools provide support to BSC.

## 5 CONCLUSIONS AND FUTURE WORK

The MINERVA framework provides support for continuous business process improvement based on its lifecycle management and its implementation by services and model driven development. It defines a BPCIP improvement process integrating into the BP lifecycle explicit measurement activities and a process to introduce improvements in a systematic way. A BP execution model (BPEMM) made up of several BP execution measures is also defined to be used in the BPCIP improvement process. BPEMM provides several execution measures related with the

defined business strategy and goals, allowing the selection and implementation of execution measures regarding the needs of the organization.

BPEMM execution measures are defined using the GQM paradigm, to provide traceability from business goals to execution measures taking into account existing and broadly used measures and proposing new ones. Execution measures are defined for: time, cost, quality and flexibility dimensions of generic BP execution, domain specific execution, lean focus execution and services execution. For each specific GQM we also provide a graphical representation in the SMTTool, which allows bringing a global vision of the measures defined. The major contribution of the BPCIP and BPEMM we have described lies in the integration of all the different methods presented, the existing execution measures and the new ones defined, to support the continuous improvement of BP implemented by services with traceability from business goals to software implementation.

As current and future work we are implementing the BPEMM as a ProM plug-in so as to import execution logs, calculate the execution measures defined and show the results to be analyzed by the business management area, thus providing support in finding improvement opportunities with respect to the achievement of the specified business goals.

## ACKNOWLEDGEMENTS

This work has been partially funded by the Agencia Nacional de Investigación e Innovación (ANII, Uruguay), ALTAMIRA project (Junta de Comunidades de Castilla-La Mancha, Spain, F. Soc. Europeo, PII2109-0106-2463), PEGASO/MAGO project (Ministerio Ciencia e Innovación MICINN, Spain, FEDER, TIN2009-13718-C02-01) and INGENIOSO project (Junta de Comunidades de Castilla-La Mancha, Spain, PEIII1-0025-9533)

## REFERENCES

- ARIS, IDS Scheer, Software AG, Germany
- Barbacci, M., Klein, M., Longstaff, T., Weinstock, C., 1995, Quality Atributtes, CMU/SEI-95-TR-021, SEI.
- Basili, V.R., 1992, Software Modeling and Measurement: The GQM Paradigm, CS-TR-2956, University of Maryland
- Bass, L., Clements, P., Kazman, R., 2003, Software Architecture in Practice, Addison Wesley
- Buglione, L., Abran, A., 2000: Balance Scorecards and GQM: what are the differences?, *FESMA-AEMES*

- Software Measurement Conference
- Brand, N., Van der Kolk, H., *Workflow Analysis and Design*, 1995.
- Cardoso J., Sheth, A., Miller, J., 2002: Workflow quality of service, In *Int. Conf. on Enterprise Integ. and Mod. Tech., Int. Enterprise Mod. Conf. (ICEIMT/IEM'02)*
- Cardoso, J., 2006: Process control-flow complexity metric: An empirical validation, In *IEEE International Conference on Services Computing (SCC'06)*
- Clements, P., Kazman, R., Klein, M., 2001, *Evaluating SW Archs: Methods and Case Studies*, Addison Wesley
- Delgado A., Ruiz F., García-Rodríguez de Guzmán I., Piattini M., 2009a: Towards a Service-Oriented and Model-Driven framework with business processes as first-class citizens, In: *2nd IC on Business Process and Services Computing (BPSC'09)*.
- Delgado A., Ruiz F., García-Rodríguez de Guzmán I., Piattini M., 2009b: MINERVA: Model driven and service oriented framework for the continuous business processes improvement & related tools, In *5th Int. Work. on Engineering Service-Oriented Applications (WESOA'09)*, LNCS
- Delgado A., Ruiz F., García-Rodríguez de Guzmán I., Piattini M., 2010a: Towards an ontology for service oriented modeling supporting business processes, In *4th IC Research Challenges Inf. Sci. (RCIS'10)*, IEEE
- Delgado, A., García - Rodríguez de Guzmán, I., Ruiz, F., Piattini, M., 2010b: Tool support for Service Oriented development from Business Processes, In *2nd Int. Work. Model-Driven Service Engineering (MOSE'10)*
- Delgado A., Ruiz F., García-Rodríguez de Guzmán I., Piattini M., 2010c: A Model-driven and Service-oriented framework for BP improvement, *Journal of Systems Integration (JSI)*, Vol.1, No.3
- Delgado, A., García - Rodríguez de Guzmán, I., Ruiz, F., Piattini, M., 2010d: From BPMN BP models to SoaML service models: a transformation-driven approach. In: *2nd Int. Conf. on Sw Tech. Engineering (ICSTE'10)*
- García, F., et al., 2005: Towards a Consistent Terminology for *Software Measurement, Inf. and SW Tech.*, 48
- Hicks, B.J., 2007: Lean information management: Understanding and eliminating waste, *Int. Journal of Information Management*, Elsevier
- Jimmerson, C., Weber, D., Sobek, D., 2005: Reducing waste and errors: Piloting Lean Principles at Intermountain Healthcare, *Journal Quality & Patient Safety*
- Kaplan, R. S., Norton, D. P., 1992: The balanced Scorecard Measures that drive performance, *Harvard Business Review*, Vol. 10, No. 1
- Laguna, M., Marklund, J., 2005: BP Modeling, Simulation and Design, Prentice Hall
- Maruster, L., van Beest, N., 2009: Redesigning business processes: a methodology based on simulation and process mining techniques, *Knowl. Inf. Syst. Journal*
- Mellor, S., Clark, A., Futagami, T., 2003: Model Driven Development-Guest eds.int., *IEEE Computer Society*
- Mendling, J., 2008: Metrics for Process Models: Empirical Foundations of Verification, Error Prediction, and Guidelines for Correctness, Springer
- Mora, B., García, F., Ruiz, F., Piattini, M., 2008: SMML: Software Measurement Modeling Language, 8th Int. Work. Domain-Specific Modeling, (OOPSLA'08)
- Netjes, M., 2010: Process Improvement: The creation and Evaluation of Process Alternatives, Eindhoven UT.
- O'Brien, L., Bass, L., Merson, P., 2005: Quality Attributes and SOA, CMU/SEI-20055-TN-014, SEI.
- OMG, 2008a, BP Modeling Notation(BPMN), v.1.2
- OMG, 2008b, Query/Views/Transformations(QVT), v.1.0
- OMG, 2008c, BP Maturity Model (BPMM), v.1.0
- OMG, 2009, Soa Modeling Language (SoaML), beta 2
- Papazoglou, M.; Traverso, P.; Dustdar, S.; Leymann, F., 2007: Service-Oriented Computing: State of the Art and Research Challenge, IEEE Computer Society
- Pino, F., Hurtado, J., Vidal, J., García, F., Piattini, M., 2009: A Process for Driving Process Improvement in VSEs, *Int. Conf. on Software Process (ICSP'09)*
- Poppendieck, M., 2002: Principles of Lean Thinking, Poppendieck.LLC.
- ProM, Process Mining Group, Eindhoven University of Technology, The Netherlands
- Reijers, H., 2003: Design and Control of Workflow Processes: *BPM for the Service Industry*, LNCS
- Rolón, E., F. García, et al., 2006: Evaluation Measures for Business Process Models, In *21st Symposium on Applied Computing (SAC'06)*
- Sánchez, González L., Delgado, A., Ruiz, F., García, F., Piattini, M., 2009: Measurement and Maturity of BP. Eds.: Cardoso, J., van der Aalst, W., Handbook of Research on BP Modeling, Inf. Science Ref., IGI Global
- Sánchez González, L., F. García, et al., 2010: *Assessment and Prediction of Business Process Model Quality*, In *18th Int. Conf. Cooperative Inf. Systems (CoopIS'10)*
- Smith, H., Fingar, P., 2003: *Business Process Management: The third wave*, Meghan-Kieffer
- van der Aalst, W. M. P., ter Hofstede, A., Weske, M., 2003: *Business Process Management: A Survey*, In *Int. Conf. on Business Process Management (BPM'03)*
- van der Aalst, W.M.P., Reijers, H. A., Medeiros, A., 2007, *Business Process Mining: an Industrial Application*, *Information Systems Vol.32 Issue 5*
- Weske, M., 2007: *BPM Concepts, Languages, Architectures*, Springer
- Wetzstein, B., Karastoyanova, D., Leyman, F., 2008: Towards Management of SLA-Aware BP Based on Key Performance Indicators, In *9th Work. BP Modeling, Development and Support (BPMDS'08)*
- zur Muehlen, M., 2004: Workflow-based Process Controlling, Foundation, Design, and Application of Workflow-driven Process IS, Logos Verlag