

Derivation of Control Input using Optimization with CFD Simulator and its Application to a Molten-metal Pouring Process

Yoshifumi Kuriyama¹, Hisashi Yamada², Ken'ichi Yano², Yuya Michioka³, Yasunori Nemoto⁴
and Panya Minyong⁵

¹*Faculty of Engineering, Gifu National College of University, Motosu, Gifu, Japan*

²*Faculty of Engineering, Mie University, Mie, Japan*

³*Technology Development Division, AISIN TAKAOKA CO.,LTD, Aichi, Japan*

⁴*Technology Division, FLOW Science JAPAN CO.,LTD, Tokyo, Japan*

⁵*Faculty of Engineering, Pathumwan Institute of Technology, Bangkok, Thailand*

Keywords: Optimization, Optimum Control, Pouring, CFD Simulator.

Abstract: Tilting-type automatic pouring machines are used for gravity casting in manufacturing processes, and their pouring speed is set by workers through trial and error. Therefore, it is difficult to achieve pouring that results in high-quality casting and high process yield. On the other hand, in recent years, this control input has been derived by computer using a CFD simulator. However, the computation of a single condition currently requires a few hours, and the entire optimization requires hundreds of such computations. Thus, a considerable amount of time is required in order to perform an optimization using a CFD simulator. The purpose of this study was to design a calculation method for a pouring machine that would reduce the calculation time. The effectiveness of the proposed system is shown through CFD simulation.

1 INTRODUCTION

In current casting factories, tilting-type automatic pouring machines are often used to pour the molten metal into the mold, with the operator relying on experience, perception and repeated testing to manually determine the pouring velocity. However, seeking an optimum multistep pouring velocity through trial and error requires an enormous number of combinations and requires highly skilled workers. For this reason, it cannot be said that suitable casting that realizes a high-quality cast is being carried out; rather, the norm is nonoptimal yield rates due to product defects and operator recalibrations. Furthermore, the extension of the production preparatory phase and increase in costs due to this kind of trial operation also become a significant problem.

Computational Fluid Dynamics (CFD) has been developed to solve this problem (Y. Kurokawa and H. Ota, 2001) (T. Sakuragi, 2004). In CFD, numerical simulations of fluid analysis based on computational fluid dynamics can analyze the behavior and the thermal hydraulics of a fluid flowing around an object. CFD is currently used not only for theoretical analysis of the behavior of fluids, but also for opti-

mization of the shape and flow of fluids for improved quality and performance of various products (Martin, 2005) (Y. Kuriyama and Watanabe, 2009). However, analysis by CFD simulator of one condition currently requires a few hours, and the entire optimization requires hundreds of such computations. Thus, a considerable amount of time is required in order to perform an optimization by CFD simulator.

With the aim of reducing this calculation time, we sought to design in this study a calculation method using a CFD simulator with optimization method. This proposed method was applied to an actual problem of a tilting-type automatic pouring machine, and derived the pouring speed by which a sprue cup could be quickly filled and the liquid level controlled at a fixed high level of liquid. The effectiveness of proposed method is shown by comparing the calculation time to iterative learning control which has been applied in past studies.

2 EXPERIMENTAL APPARATUS

The experimental apparatus is shown in Fig.1. This automatic tilting type pouring machine has a tank

with a melting furnace to control the temperature of the molten metal. Thus, the viscosity of the molten metal was maintained. The capacity of the tank was 300[kg].

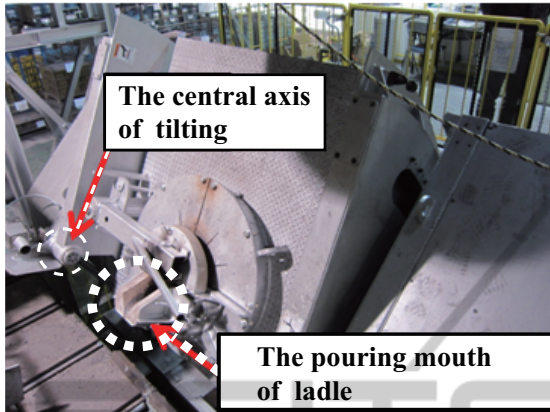

Figure 1: Overview of the automatic pouring machine.

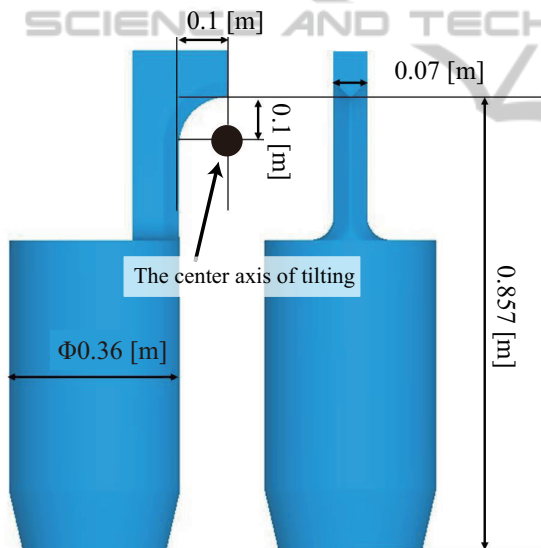

Figure 2: Measurement of a tank.

Fig.2 shows the measurement of the tank, and Fig.3 presents an overview of the sprue cup. In Fig.3, a molten metal filter (wire mesh) is installed in the sprue runner for the purpose of removing slag.

3 SETTING THE CFD SIMULATOR

Our fluid analysis software is a 3D fluid calculation program that uses a calculus of finite differences for handling a wide range of flows, from the flow of an

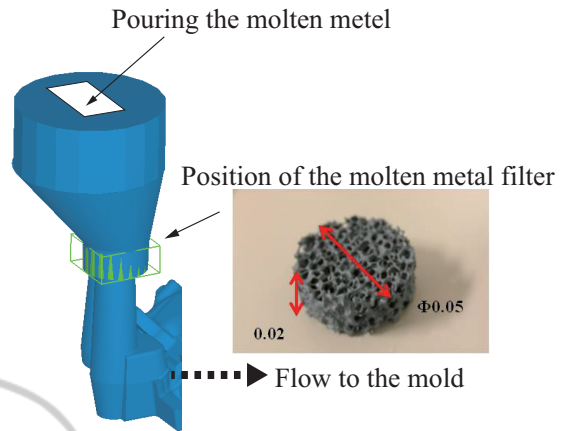

Figure 3: Overview of a casting mold.

incompressible fluid and flow accompanied by an adjustable surface to the flow of a compressible fluid flow accompanied by solidification. The free surface is calculated using the Volume Of Fluid (VOF) method(C.W.HirtCB.D.Nichols, 1981). The geometry of complex objects is handled using the Fractional Area Volume Obstacle Representation (FAVOR) method(C.W.HirtCJ.M.Sicilian, 1985).

3.1 Setting of the Casting Mold

In this study, cast steel is assumed as the molten metal, and its fluid properties are shown in Table 1. The weight of the casted product is 26[kg], and the volume is $3.65 \times 10^{-3} [m^3]$. The temperature of the molten metal in the melting furnace is set to a value of about 1200°C.

This product has thin-wall parts. Thus, it is advisable to set as fine a mesh as possible. Table 2 shows the minimum settings to perform the calculations quickly and accurately. This analysis time was 12 hours.

Table 1: Fluid parameters of Ductile Cast Iron.

Fluid parameters	Ductile Cast Iron
Density	7620 [kg/m ³]
Viscosity	0.008 [Pa·s]
Temperature of the Fluid	1873 [K]
Specific Heat	1032 [J/(kg·K)]
Thermal Conductivity	23.2 [W/(m·K)]
Liquidus Temperature	1769 [K]
Solidus Temperature	1615 [K]

3.2 Setting of the ladle

As seen in Fig.2, the ladle part is symmetrical. Thus, the analysis area is given as a one-sided model to re-

Table 2: Mesh Parameters for sprue cup.

	cell size[m]	Number of cell
X-direction	0.0016	254
Y-direction	0.0016	153
Z-direction	0.0016	192
Total cell count		7,697,924
Active cell count		772,331

Table 3: Mesh Parameters for ladle.

	cell size[m]	Number of cell
X-direction	0.01-0.0025	94
Y-direction	0.01	20
Z-direction	0.01-0.025	112
Total cell count		240,770
Active cell count		61,104

duce the analysis time. Table 3 shows the minimum settings to perform the calculations quickly and accurately, and the mesh parameter is set such that a rough mesh is used around the bottom part of the tank because the fluid is stable in that section. On the other hand, a fine mesh is used around the tapping hole because the fluid velocity is high and the fluid is unstable in that section.

Fig.4 indicates the angular velocity curve of the ladle. The tilting has three parts. In the first part, the ladle is tilted until just before outflow. In the second part, the ladle starts to pour. In the third part, the ladle is tilted back to stop the pouring.

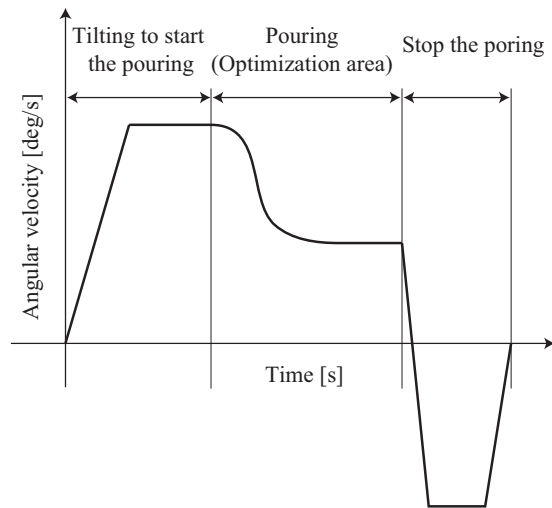

Figure 4: Tilting motion of the ladle.

3.3 Setting of the Molten Metal Filter

In the CFD simulator, the molten metal filter is set by using the equation of flow loss as shown in Eq.(1).

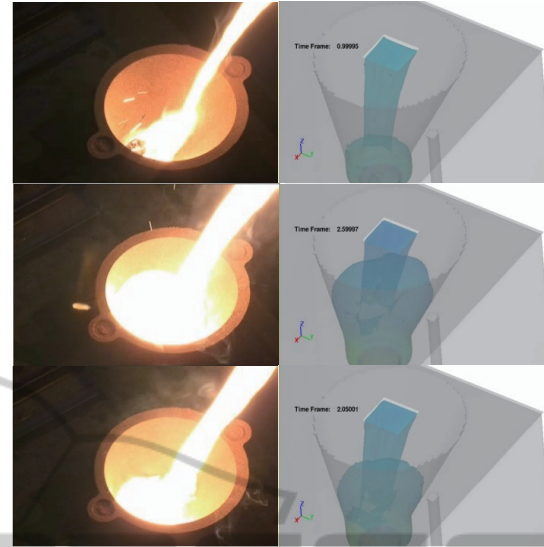

Figure 5: Comparison of flow in sprue cup.

To identify the parameter for flow loss, the parameter of porosity is calculated using Archimedes' principle. As a result, the parameter of porosity is $V_F=0.837$, and the diameter of the fiber is $d=0.001$ [m]. The other parameter is identified by comparing the fluid behavior. As a result, α is 180 and β is 2.0.

Comparing these with the pouring test results as shown in Fig.5, it can be seen that a satisfactory reproduction of the molten metal behavior inside the sprue was achieved.

$$K = \frac{\mu}{\rho} \frac{1-V_F}{V_F^2} \left[ADRG(1-V_F) + BDRG \frac{ReV_F}{d} \right] \quad (1)$$

$$ADRG = \alpha/d^2 \quad BDRG = \beta/d$$

4 PROPOSED CALCULATION METHOD

Fig.6 shows the proposed calculation method. In this method, the mathematic model(Yoshiyuki Noda, 2005)(Yoshiyuki Noda, 2011) and the CFD simulator are included. The reference angular velocity ω [rad/s] is derived by optimization method. In this study, genetic algorithm (GA) was applied as a optimization method. Using this ω [rad/s], the outflow q from the ladle is calculated by the mathematic model, and the fluid level h_c of the cup is calculated by mathematical model with outflow q . Then, the model errors of the mathematical model are modified by the CFD simulator. Finally, comparing the maximum fluid level, the optimization method derives the reference angular velocity, which is a satisfied constraint.

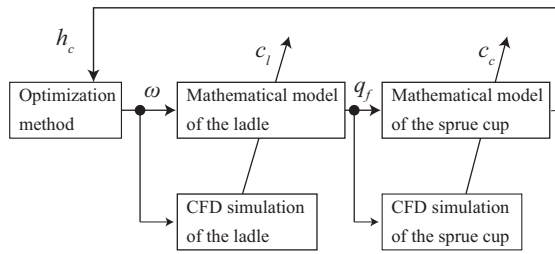

Figure 6: Proposed calculation method.

4.1 Modeling of the Ladle

Eq.(2) indicates the model of the outflow from the ladle. This equation derives the volume of pouring q_f [m³/s] from the angular velocity $\omega(t)$ [rad/s] of the ladle. Fig.7 and Fig.8 show each variable, where h [m] is the minimum fluid level from the liquid surface to the pouring mouth, and $V_s(\theta(t))$ [m³] is the residual volume of fluid. $A(\theta(t))$ [m²] is the fluid surface, and L_n [m] is the width of the pouring mouth. In this equation, the fluctuation of the fluid affected by fluid behavior or the centrifugal force is not considered because the maximum tilting speed is sufficiently low.

The variables $A(\theta(t))$ and $V_s(\theta(t))$ are calculated by fitting curve. Fig.9 and Fig.10 show the analysis result.

$$\frac{dV_r(t)}{dt} = -c_l \int_0^{V_r(t)} \frac{V_r(t)}{A(\theta(t))} (L_f \sqrt{2gh_b}) dh_b - \frac{\partial V_s(\theta(t))}{\partial \theta(t)} \omega(t)$$

$$q(t) = c_l \int_0^{V_r(t)} (L_f \sqrt{2gh_b}) dh_b \quad (2)$$

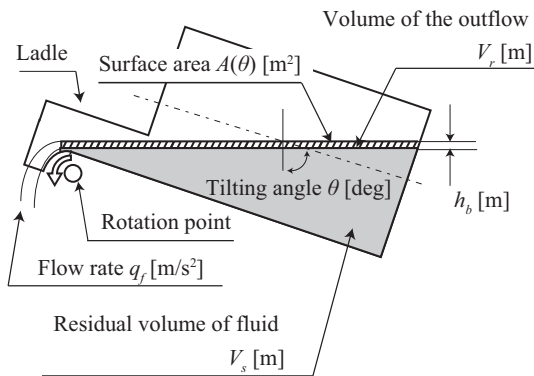

Figure 7: Variables for the mathematical model of ladle.

4.2 Modeling of the Sprue

Eq.(3) represents the fluid level model of the sprue cup. This equation derives the fluid level h_c from the

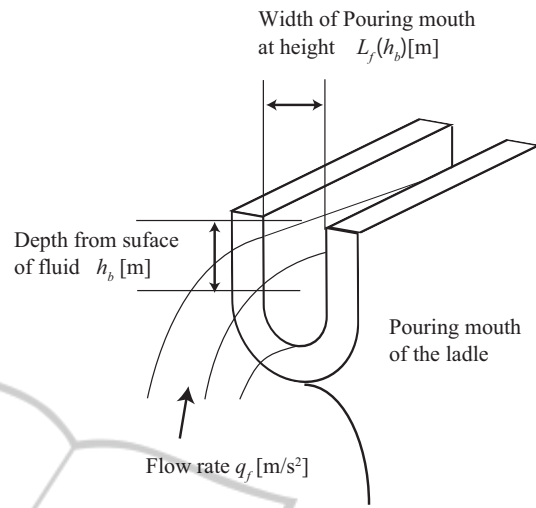

Figure 8: Variables of the pouring mouth.

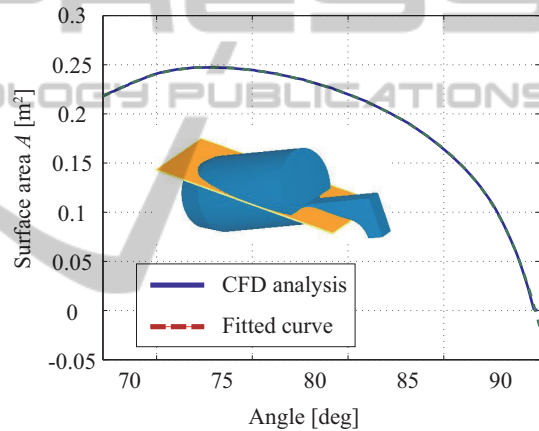

Figure 9: Surface area A at the angle θ .

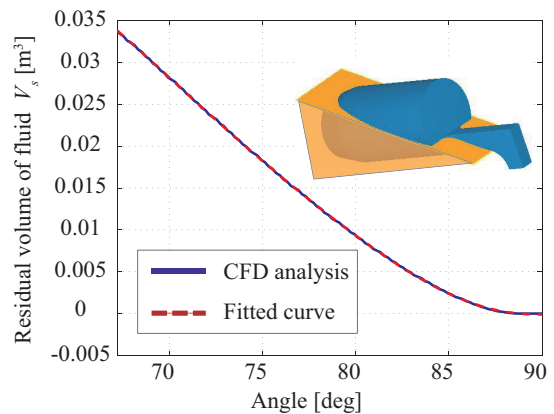

Figure 10: Volume of fluid V_s at the angle θ .

volume of pouring q_f . Fig.11 shows each variable, where h_c is the fluid level at the timer t , A_c is the fluid surface, A_{Exit} is the area of bottom of the cup, q_{Exit} is the outflow to the mold, and h_{ref} is the maximum

Table 4: Parameters of the fitting curve.

	A	V_s	A_c
a_1	0	$3.2e^{-11}$	0
a_2	0	0	0
a_3	$-3.0e^{-4}$	0	0
a_4	$-3.8e^{-2}$	$-7.0e^{-4}$	$-1.0e^{-4}$
a_5	-2.9	$5.6e^{-2}$	$4.0e^{-4}$
a_6	134.4	-2.8	$6.0e^{-4}$
a_7	-3431.9	77.4	$1.4e^{-3}$
a_8	37506.3	-912.3	$3.8e^{-3}$

liquid level.

The variables A_c is calculated by fitting curve. The analysis result are shown in Fig.12.

The fitting curve is shown in the Eq.4, and the parameters are shown in Table 4.

$$\frac{dh_c(t)}{dt} = \frac{q_f(t) - q_{Exit}(t)}{A_{(h_c)}} \quad (3)$$

$$q_{Exit}(t) = c_c * A_{Exit} \sqrt{2gh_c}$$

$$y = a_1x^7 + a_2x^6 + a_3x^5 + a_4x^4 + a_5x^3 + a_6x^2 + a_7x^1 + a_8 \quad (4)$$

5 OPTIMIZATION OF THE ANGULAR VELOCITY CURVE

5.1 Derivation the pouring Start Angle and End Angle

The pouring angle area is determined by the pouring start angle θ_a and end angle θ_b , by which the molten metal can be poured to fill the reference volume with least displacement angle. Eq.(5) represents the formula for the computation, and Fig.13 shows the volume change of fluid per degree. In this figure, ρ is density and M is the mass of the produced unit. In this study, M is 24.1[kg]. As the analysis result, start angle θ_a is 71.1[deg], and end angle θ_b is 72.3[deg].

$$\theta_{min} = \min \left\{ \theta_b - \theta_a; M \approx \rho \left(\int_{\theta_a}^{\theta_b} A(\theta) d\theta \right) \right\} \quad (5)$$

5.2 Equation of Reference Fluid Level Curve

In this study, the fluctuation of fluid level are derived in two parts as shown in Fig.14. The first part is for

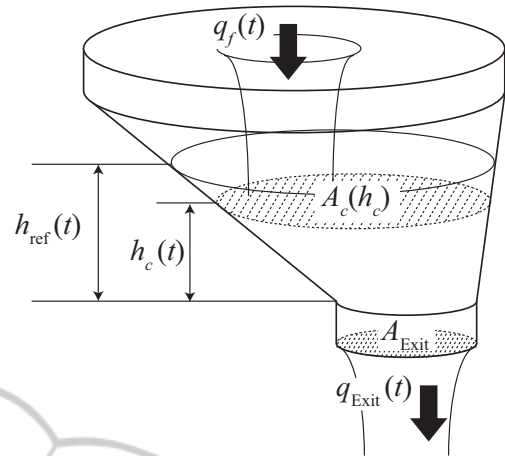
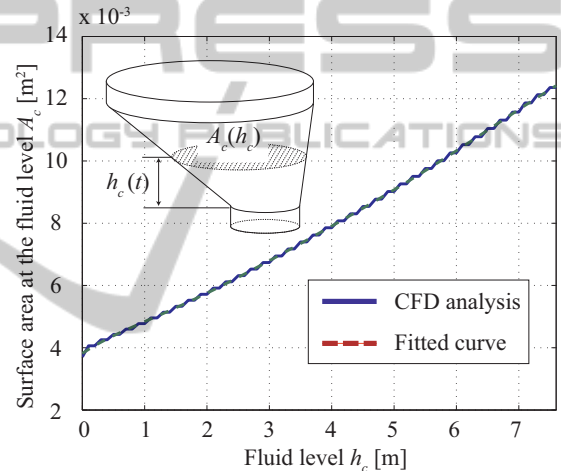

Figure 11: Variables for the mathematical model of the sprue cup.

 Figure 12: Surface area at the fluid level h_c .

the rising of the liquid, the second part is for the equilibrium of the liquid, where t_{end} is the finish time of the rising of the liquid, T_s is the finish time of pouring, h_m is the reference height.

The reference fluid level velocity curve of the rising part is defined by Eq.(6)~Eq.(8), where t is the time and, $a_i (i = 0 \sim 7)$ are the constants.

$$f(t) = \sum_{i=0}^n a_i t^i \quad (6)$$

$$f'(t) = \sum_{i=0}^{n-1} (a_{i+1} t^i) (i+1) \quad (7)$$

$$f''(t) = \sum_{i=0}^{n-2} (a_{i+2} t^i) (i^2 + 3i + 2) \quad (8)$$

The initial conditions are $f(0)=0.0$ [m], $f'(0)=0.0$ [m/s], $f''(0)=0.0$ [m/s²], the conditions at $t=t_{end}$ are $f(t_{end})=h_m$ [m], $f'(t_{end})=0.0$ [m/s], $f''(t_{end})=0.0$ [m/s²]

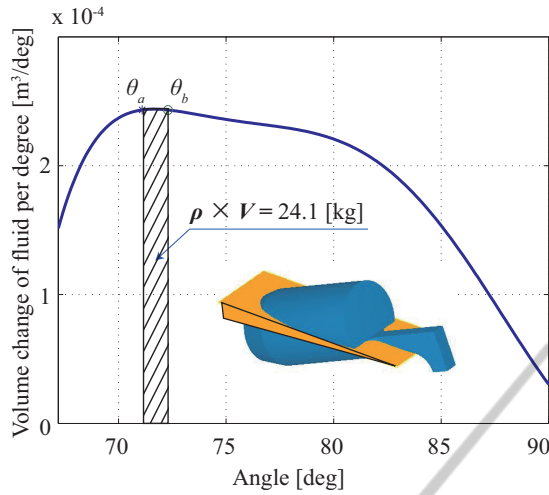

Figure 13: Volume change of fluid per degree.

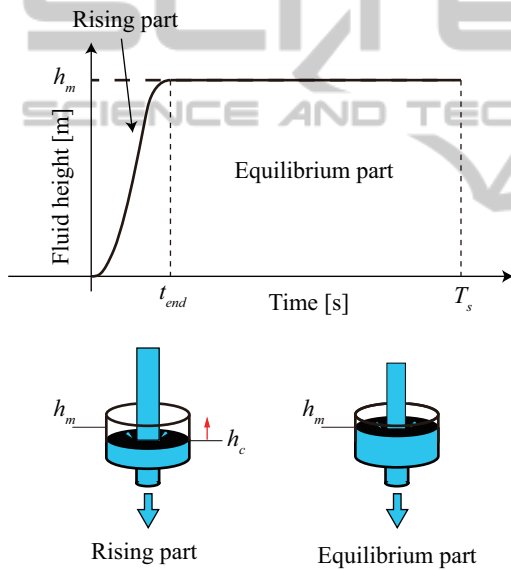

Figure 14: Reference fluid level curve.

Therefore, (9) is solved by substituting the initial conditions into (6) ~ (8).

$$a_0 = a_1 = a_2 = 0 \quad (9)$$

From the conditions at $t=t_{end}$, (10)~(12) are also given as

$$a_5 = \frac{6h_m - 6a_7t_1^7 - 3a_6t_1^6}{t_1^5} \quad (10)$$

$$a_4 = \frac{-15h_m + 8a_7t_1^7 + 3a_6t_1^6}{t_1^4} \quad (11)$$

$$a_3 = \frac{10h_m - 3a_7t_1^7 - a_6t_1^6}{t_1^3} \quad (12)$$

where the t_{end}, h_m, a_7, a_6 are unknown parameters solved by optimization problem using GA.

5.3 Formulation of Design Specifications

The specification of the reference fluid level curve are formulated by making use of penalty functions, and then t_{end}, h_m, a_7, a_6 are simultaneously calculated to satisfy the specifications. In this design, Specs.(I)-(III) shown below were given.

Spec.(I): The maximum angular velocity of the ladle do not exceed the pouring machine constraint. Penalties are given if the following relation is not satisfied.

$$\max(\omega_t) > 0.14 \text{ [rad/s]} \quad (13)$$

Spec.(II): The allowed pouring time T_s do not exceed the production constraint. Penalties are given if the following relation is not satisfied.

$$T_s > 5 \text{ [s]} \quad (14)$$

Spec.(III): The spilling liquid Q_{spill} [m^3] from the sprue cup is more than 0 [m^3], where this spec is evaluated by using CFD simulator. Penalties are given if the following relation is not satisfied.

$$Q_{spill} > 0 \text{ [m}^3\text{]} \quad (15)$$

The unknown parameters of t_{end}, h_m, a_7, a_6 are obtained by minimizing the cost function expressed as

$$J_s = T_s + J_p \quad (16)$$

In (16). T_s is the settling time of the transfer expressed as follows Eq.(17), and J_p is the penalty term expressed as Eq.(18)

$$T_s = \{t \mid \rho \cdot q_{Exit}(t) = M\} \quad (17)$$

$$J_p = J_I + J_{II} + J_{III} \quad (18)$$

where $J_i = 10^8$ ($i = \text{Spec.(I), Spec.(II), Spec.(III)}$) is the penalty. Each time the penalty conditions hold, the penalty, which is big enough to avoid the penalty conditions, will be added to satisfy the specifications. In order to obtain the reference fluid level curve, the optimization problem with the constraints is formulated with: the target function (the pouring time $T_s \rightarrow$ minimum) and the constraints Eq.(13) ~ Eq.(15). In the Eq.(10)~ Eq.(12), t_{end}, h_m, a_7, a_6 are unknown parameters. The unknown parameters are computed by solving the optimization method with the constraints expressed in Eq.(16).

To optimize the cost function, the GA is applied to the present problem because there are four unknown parameters in this case. Table 5 shows the genetic algorithm parameters.

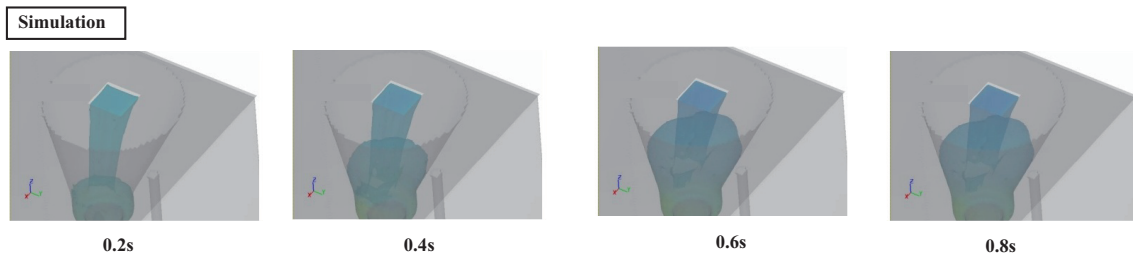

Figure 17: Fluid behavior of the fluid in the sprue cup by using CFD simulation.

Table 5: Parameters for genetic algorithms.

Number of population	30
Number of elite preservation	2
Crossover fraction	80[%]
Mutation evolution	5[%]
Crossover	One-point crossover
Selection	Roulette wheel selection

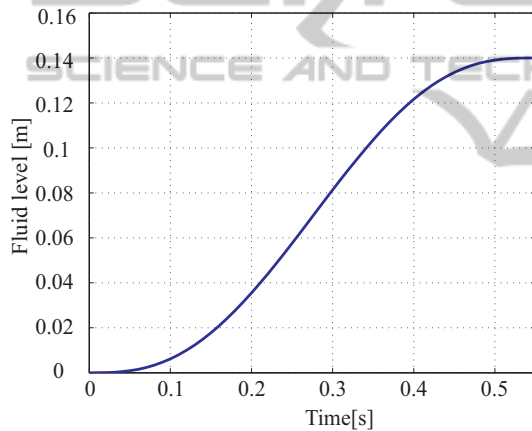

Figure 15: Optimum reference fluid level curve.

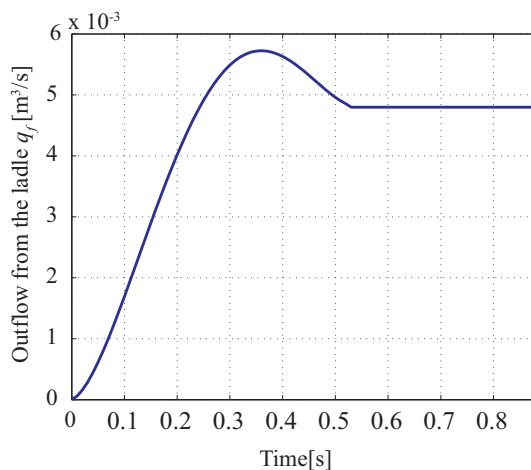

Figure 16: Outflow from the ladle.

6 OPTIMIZATION RESULT

The calculation time was 32 hours until the finish. the number of iterations of the convergence is around 33, and the settling time is converged at 1.49[s]. As a result of the computations, each parameter is $t_{end}=0.546[s]$, $h_m=0.136[m]$, $a_7=0.258$, $a_6=0.810$, $a_5=14.925$, $a_4=-21.772$, $a_3=8.1169$. The intended reference fluid level curve is shown in the Fig.15, and Fig.16 shows a simulation result of outflow from the ladle using the reference fluid level curve. Comparing the calculation time to the iterative learning control, the latter required 5 [days] to obtain the same result. Thus, it can be said that the calculation speed was improved. Fig.17 shows a result of the CFD simulation. In this figure, the liquid level can be controlled at a fixed high level.

7 CONCLUSIONS

The aim of this study was to design a calculation method using the CFD simulator with optimization method. This proposed method was applied to an actual problem of a tilting-type automatic pouring machine, and derived the pouring speed by which a sprue cup could be swiftly filled and the liquid level controlled at a fixed high level. The proposed method could derive the expected flow rate, and the calculation time was 32 hours from start to finish. The iterative learning control required 5 [days] of calculation to obtain the same result. Thus, it can be said that the calculation speed was improved.

REFERENCES

- C.W.HirtCB.D.Nichols (1981). Vokume of fluid (vof) method for the dynamics of free boundaries. In *Journal of Computational Physics*. Elsevier.
- C.W.HirtCJ.M.Sicilian (1985). A porosity technique for the definition of ovstacles in rectangular cell meshues. In

- Proc. of 4 th International Conference on Ship Hydrodynamics*. Naval Architecture and Marine Engineering.
- Martin, P. S. P. C. M. (2005). Integrating multibody simulation and cfd : toward complex multidisciplinary design optimization. In *JSME international journal*. Japan Society of Mechanical Engineers.
- T.Sakuragi (2004). Prediction of gas defects by mold-filling simulation with consideration of surface tension. In *J.JFS*. Japan Foundry Engineering Society.
- Y. Kuriyama, K. Y. and Watanabe, M. (2009). Solution search algorithm for a cfd optimization problem with multimodal solution space. In *Proc. of World Foundry Congress*. WFC.
- Y.Kurokawa, N. and H.Ota (2001). Classification of pin hole defect of iron casting. In *J.JFS*. Japan Foundry Engineering Society.
- Yoshiyuki Noda, Kenfichi Yano, K. T. (2005). Control of self-transfer-type automatic pouring robot with cylindrical ladle. In *16th IFAC World Congress*. IFAC.
- Yoshiyuki Noda, Michael Zeitz, O. S. K. T. (2011). Flow rate control based on differential flatness in automatic pouring robot. In *CCA 2011*. IEEE.

