

WIRELESS POWER TRANSMISSION IN URSI

Naoki Shinohara¹

¹*Research Institute for Sustainable Humanosphere, Kyoto University, Gokasho, Uji, Kyoto, Japan
shino@rish.kyoto-u.ac.jp*

Keywords: Wireless Power Transmission, Energy Harvesting, Rectenna, Beam Forming, Phase Array

Abstract: In URSI, Inter-Commission Working Group on Solar Power Satellites (SPS) was established in 2002 and the URSI Board has been working on writing and reviewing an URSI White Paper on SPS, which was published on June 2007, because the SPS is one of huge application of radio science. One of important application of the radio science on the SPS is a wireless power transmission (WPT) via microwave (microwave power transmission ; MPT). At first, the WPT walked along with the SPS. But now we have some kinds of the WPT and its commercial applications. One of important application of the WPT is an energy harvesting. The other is MPT for the SPS. Some important researches are done as URSI activities in Japan. It is high efficiency rectenna development at low power and at wide band frequency. It is also high efficiency and low cost phased array for the MPT and the SPS. Some of them were published in URSI conference. In this paper, I will show mainly present status of the WPT in Japan and in the world and will also show a relationship between the WPT and the URSI activities.

1 INTRODUCTION

In URSI, Inter-Commission Working Group on Solar Power Satellites (SPS) was established in 2002 and the URSI Board has been working on writing and reviewing an URSI White Paper on SPS because the SPS is one of huge application of radio science. The White Paper on SPS was published on June, 2007(SPS White Paper, 2013). One of important application of the radio science on the SPS is a wireless power transmission (WPT) via microwave (microwave power transmission ; MPT). The MPT researches walked along the SPS researches from the end of 1960s(Brown, 1984)(Matsumoto, 2002). The SPS was one and only application of the MPT because the commercial or industrial MPT system, especially antennas, theoretically become larger than that imagined by users. But in 21st century, some new WPT systems arise to be applied for the commercial or industrial uses(Shinohara, 2011). One is called a resonance coupling WPT which was

established by MIT's group in 2006. The other is called an energy harvesting which includes rectifying technologies from weak broadcasting radio waves and power generations from vibration, heat, and light, etc. Technologies for the energy harvesting from radio waves and for the MPT are the same. Difference is only that the energy harvesting is a passive system only with a rectenna, rectifying antenna, against that the WPT is an active system with a power transmitter (Fig.1). The energy harvesting is supported by low power device technologies and is applied for ubiquitous sensor network or simple wireless communications. On contrary, we can transmit power and information simultaneously on the WPT system. The URSI can support to make new theory of the MPT including the energy harvesting and the SPS and can advance its commercialization. In this paper, I will show mainly present status of the WPT in Japan and in the world and will also show a relationship between the WPT and the URSI activities.

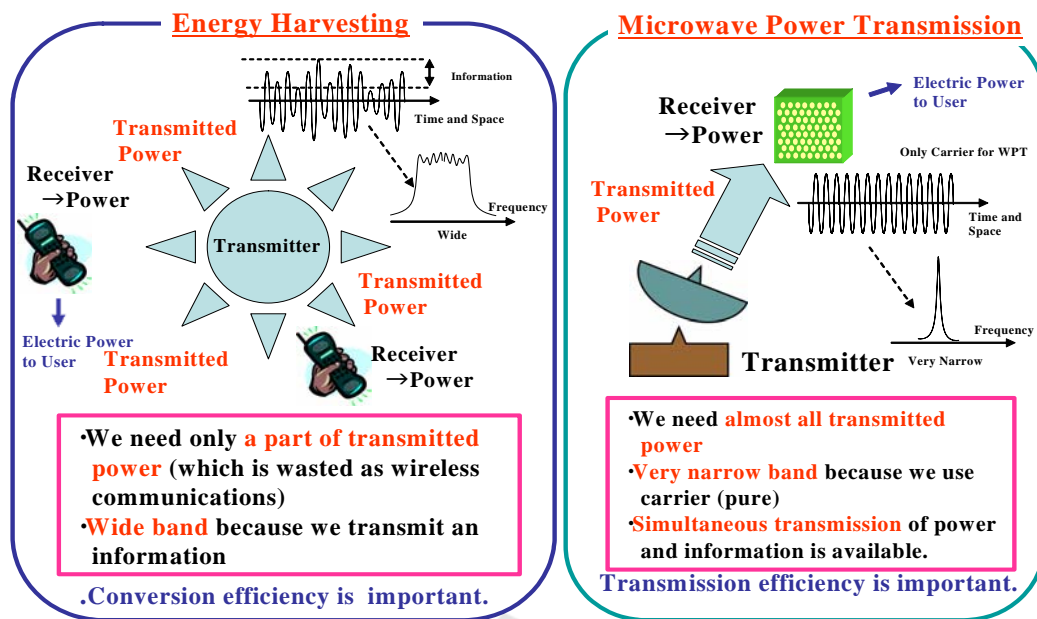

Figure 1 Microwave Power Transmission and Energy Harvesting

2 ENERGY HARVESTING

An energy harvesting is most hopeful wireless power application recently because there have been no allowed frequency for a wireless power transmission in the world. The energy harvesting does not require special frequency because the system is passive and the wireless power is harvested from broadcasting radio waves or waves of wireless communications. There are a lot of researches and developments of the energy harvesting systems in the world (Sample, 2009) (Collado, 2012) (Visser, 2013) (Popovic, 2013). Some of them are researches based on RF-ID technologies and some of them are that based on the energy harvesting from the other power source like vibration or solar.

In Japan, there are also some trials of the energy harvesting from broadcasting waves. One is carried out by ATR (Advanced Telecommunications Research Institute International). They evaluated an energy harvesting system from an 800 MHz cellular BS. For this system, they developed an 800 MHz band twin-loop antenna and an RF-DC conversion circuit. The antenna gain of 5.2 dBi and the RF-DC conversion efficiency of 9 % at -20 dBm input power were obtained. Experimental results showed that a 1.0 F electric double layer capacitor was charged up to 469 mV in 19 hours and drove a low

power LCD thermometer for 10 minutes using its stored energy (Kitazawa, 2013).

The other group is Univ. of Tokyo. They developed an energy harvesting system from UHF (at 550MHz) broadcasting wave. They chose charge pump rectifying circuit to charge the tank capacitor to 1.8 and 3.0V are 38 and 70 micro-watts respectively at 550 MHz. At a distance of 6.5km from Tokyo TV tower, the energy harvesting circuit charges up the 100uF charge tank to 2.9V in 3minutes making such a device ideal for battery less operation of wireless sensors for remote monitoring/sensing in most urban areas using just the existing terrestrial TV broadcast infrastructure for power (Vyas, 2012).

Kyoto University's group focuses on development of high efficiency rectenna at low power and at wide band frequency. First of all, we, Kyoto University's group, developed high efficiency rectenna at 5.8GHz with pure spectrum in a MPT system. We proposed a concept of 'Ubiquitous Power Source (UPS)' with the MPT technologies (Shinohara, 2005). In the UPS system, we transmit a microwave power whose microwave is not modulated and pure spectrum and whose power is limited below 1mW/cm², safety regulation for human. We chose frequency of 2.45GHz or 5.8 GHz which are on ISM (Industrial, Science, and Medical) band. We developed high efficiency rectenna at low power with expectation of

application for the UPS and the energy harvesting. A picture of the developed rectifying circuit of the rectenna is shown in Fig.2. Target frequency is 5.8GHz continuous wave (CW). The circuit is based on shingle shunt full wave rectifier whose theoretical RF-DC conversion efficiency is 100% with one diode only. As a rectifying theory, line length between a diode and a capacitance (C2) must be $\lambda/4$ for 100% efficiency. However, we change the line length between a diode and a capacitance to increase the RF-DC conversion efficiency at 1mW. As a result, we achieved approximately 50% of the RF-DC conversion efficiency at 1mW, 1k Ω in 5.8GHz CW(Fig.3).

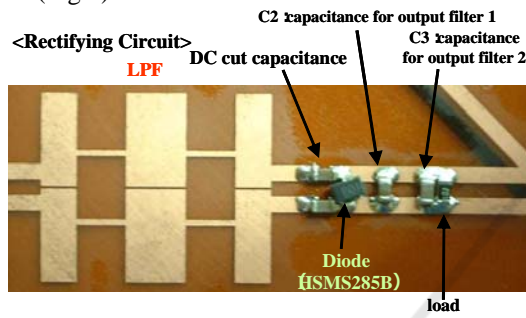

Figure 2 Developed Rectenna for Rectifying of Low Power

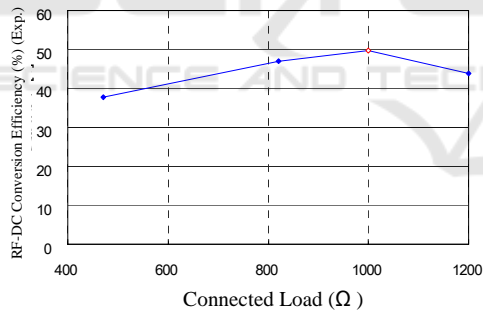

Figure 3: Experimental Result of Load Characteristics of RF-DC Conversion Efficiency at 1mW input microwave power (without Low-Pass Filter)

For 2.45GHz system, we chose the other approach to increase the RF-DC conversion efficiency of the rectenna. Optimization of the line length between a diode and a capacitance was the same. However, we could not increase the efficiency enough with one diode only. Therefore, we increased a number of the diodes and put them like a charge pump rectifier without capacitances (Fig.4). As circuit simulations, we achieved 55.3% at 0.1mW, 8.2k Ω in 2.45GHzCW with type of 6EA (Fig.5). All

distributed lines and capacitances are optimized and different in each circuit. Optimum connected loads are also different in each circuit. This was collaborative research with Kyoto University and Mitsubishi Electric Corporation.

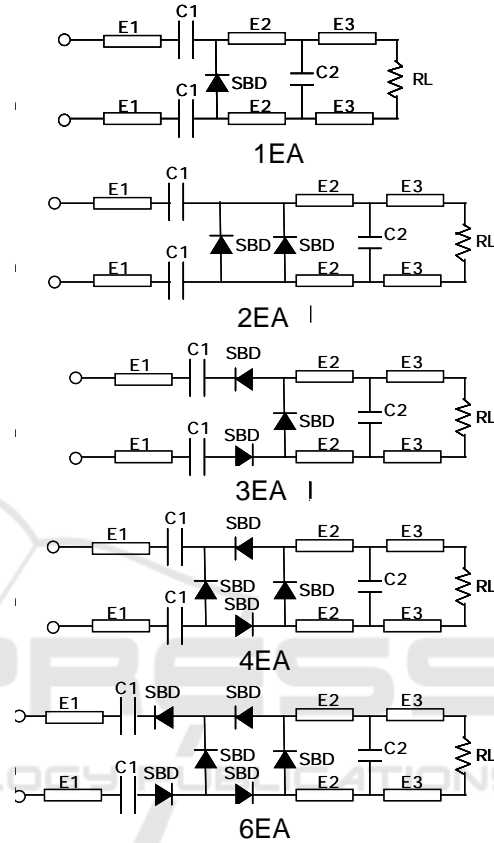

Figure 4 Proposed Rectifying Circuits in 2.45GHzCW (E : Distributed Line, C : Capacitance, SBD : Shottky Barrier Diode)

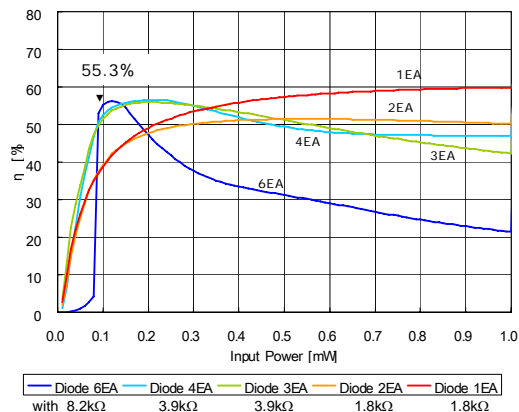

Figure 5 Simulation Results of Proposed Rectifying Circuits in 2.45GHzCW

RF-DC conversion efficiency of these rectennas at low input power is high. However, these are only for continuous waves. We have to develop a rectenna for modulated radio waves whose frequency range is wide. Theoretically, it is difficult to increase RF-DC conversion efficiency by modulated radio waves because some high Q circuits like distributed lines are used to increase the efficiency in a single shunt rectifier. For an energy harvesting with high efficiency, we, Kyoto University and NTT, proposed new rectifying circuit based on the single shunt rectifier in 2013(Shinohara and Hatano, 2013). It is in 24GHz band. The experimental result is shown in Fig.6. We put sector-type open stubs as resonators at higher harmonics instead of a capacitance in a single shunt rectifier. Compared with normal stubs as resonators at higher harmonics, the frequency range is expanded.

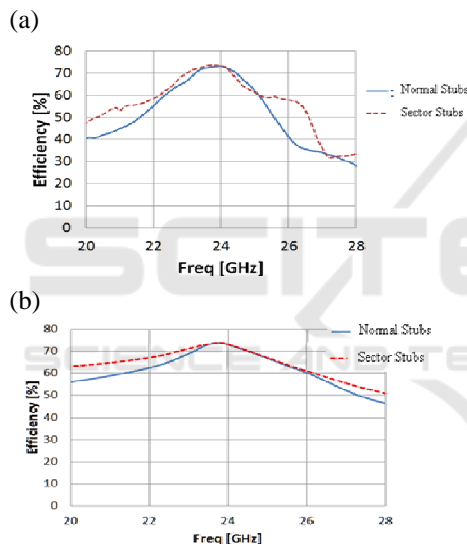

Figure 6 Simulation Result of RF-DC Conversion Efficiency of Class-F Load Rectenna with Sector Stubs(a) with Impedance Matching at 24GHz (b) with Impedance Matching at All Frequencies (Shinohara, 2013)

3 MICROWAVE POWER TRANSMISSION

In URSI activities, we mainly focused on a MPT and a SPS as a MPT application in Japan. Especially, high efficiency beam forming in the MPT and the SPS system is important work. It is not only a new beam forming theoretical algorithm but also a beam

forming algorithm with considering a phased array system.

For the SPS, phased arrays for the MPT were historically developed (Shinohara, 2013). Magnetron phased array developed in Kyoto University is one of hopeful phased array for the SPS. We developed phase controlled magnetron for the SPS. However, one magnetron generates high microwave power, for example, 1kW. For the SPS, the high output power is a weak point because an output power from 1 antenna in the SPS will be less than 1 W. We have to coexistent both beam forming without grating lobes and high efficiency array. In order to coexistent both, we consider two systems. One is a phased array with power divider and sub-phase shifters whose loss are small, between antennas and a magnetron (Shinohara, 2002). We showed that we could keep high beam collection efficiency at wider beam scanning with magnetron phased array with sub-phase shifter, comparing the simple magnetron phased array. Based on the result, we developed magnetron phased array with sub-phase shifters in Kyoto University (Fig.7). The research results were referred in URSI White paper on SPS.

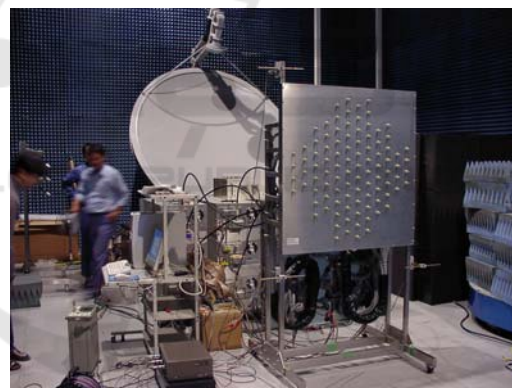

Figure 7 Magnetron Phased Array with Phase Controlled Magnetron through 1-bit sub-phase shifters after 8-way power dividers

The other approach to coexistent both beam forming without grating lobes and high efficiency array, we proposed new random array to suppress grating lobes and to increase beam collection efficiency simultaneously (Shinohara, 2008) (Shishkov, 2009)(Shishkov, 2011). In conventional random array, we can suppress grating lobes with large antenna spacing like a magnetron array. However, energy of the grating lobes merges not to main lobe but to side lobes. As a result, beam collection efficiency of large spacing array with grating lobes and random array without grating lobes

are the same and low. With our new proposed element spacing algorithm, grating lobes are suppressed and beam collection efficiency is increased simultaneously (Fig.8).

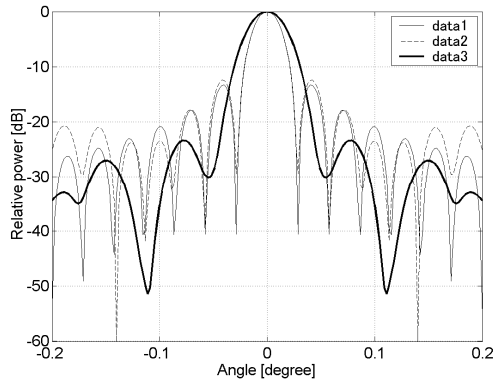

Figure 8 Beam Patterns of data3 (Proposed New Positioning Algorithm) and data2 (Conventional Random Array), data1 (Uniform Array) for 1000 elements, average spacing $d_{av} = 2\lambda$ and uniform excitation (Shinohara, 2008)

4 CONCLUSIONS

Radio waves can carry not only information but also energy. A wireless power transmission is one of important new radio scientific and technical region in URSI. In this paper, I only show technical results of the WPT and an energy harvesting. However, propagation, plasma physics, EMC and biomedical of the radio wave are also very important matters to realize commercial WPT and the SPS. I hope fruitful discussions will be in URSI.

REFERENCES

- Brown, W. C., 1984. *The history of power transmission by radio waves*, IEEE Trans. Microwave Theory and Techniques, MTT-32, No.9, pp.1230-1242
- Collado, A., and A. Georgiadis, 2012. *Improving Wireless Power Transmission Efficiency Using Chaotic Waveforms*, Proc. of IMS2012, TU4F-1, 1849-LL5P2GLnBqBm-2.pdf
- Kitazawa, S., M. Hanazawa, S. Ano, H. Kamoda, H. Ban and K. Kobayashi, 2013. *Field Test Results of RF Energy Harvesting from Cellular Base Station*, Proc. of GSMM2013, 1569736061.pdf
- Matsumoto, H., Dec. 2002. *Research on Solar Power Station and Microwave Power Transmission in Japan: Review and Perspectives*, IEEE Microwave Magazine, pp.36-45
- Popovic, Z., E. Falkenstein, and R. Zane, 2013. *Low-Power Density Wireless Powering for Battery-less Sensors*, Proc. of RWS2013, MO3A, pp.31-33
- Sample, A. P. and J.R. Smith, 2009. *Experimental Results with two Wireless Power Transfer Systems*, Proc. of RWS2009, MO2A-5, pp.16-18
- Shinohara, N., H. Matsumoto, and K. Hashimoto, 2002. *"Solar Power Station/Satellite (SPS) with Phase Controlled Magnetrons"*, Proc. of 2002 Asia-Pacific Microwave Conference (APMC), pp.2-795-798
- Shinohara, N., T. Mitani, and H. Matsumoto, 2005. *Study on Ubiquitous Power Source with Microwave Power Transmission*, Proc. of URSI General Assembly 2005, C07.5(01145).pdf
- Shinohara, N., B. Shishkov, H. Matsumoto, K.Hashimoto, and A.K.M. Baki, 2008. *New Stochastic Algorithm for Optimization of Both Side Lobes and Grating Lobes in Large Antenna Arrays for MPT*, IEICE Trans. Communications, Vol.E91-B, No.1, pp.286-296
- Shinohara, N., 2011, *Power without Wires*, IEEE Microwave Magazine, Vol.12, No.7, pp.S64-S73
- Shinohara, N., K. Hatano, T. Seki, and M. Kawashima, 2013. *Development of Broadband Rectenna at 24GHz*, Proc. of GSMM2013, 1569734001.pdf
- Shinohara, N., 2013. *Beam Control Technologies With a High-Efficiency Phased Array for Microwave Power Transmission in Japan*, Proceeding of IEEE, 10.1109/JPROC.2013.2253062, 0020-SIP-2012-PIEEE
- Shishkov, B., K. Hashimoto, H. Matsumoto, N. Shinohara and T. Mitani, 2009. *Direction Finding Estimators of Cyclostationary Signals in Array Processing for Microwave Power Transmission*, Pliska Stud. Math. Bulgar., Vol.19, pp.245-268
- Shishkov, B., N. Shinohara, H. Matsumoto, K. Hashimoto, and T. Mitani, 2011. *On the Minimization of Side-Lobes in Large Antenna*, Proc. of URSI General Assembly 2011, CD-ROM CHGBDJK-5.pdf
- SPS White Paper, <http://www.rish.kyoto-u.ac.jp/SPS/index.html>, 2013
- Visser, H. J., 2013. *Printed Folded Dipole Antenna Design for Rectenna and RFID Applications*, Proc. of EuCAP2013, pp.2766-2769
- Vyas, R. J., H. Nishimoto, M. Tentzeris, Y. Kawahara, T. Asami, 2012. *A Battery-Less, Energy Harvesting Device for Long Range Scavenging of Wireless Power from Terrestrial TV Broadcasts*, Proc. of IMS2012, TU4F-2, 2060-LL6Ai1QvYbBc-2.pdf
- Yamamoto, A., H. Okegawa, N. Shinohara, and H. Matsumoto, 2006, *Development of High Efficiency Thin Film Rectenna for Low-Power Input*, Prof. of the 3rd International Symposium on Sustainable Energy System, p.219