

# The Role of Modeling and Simulation in Coordination of Health Care

Bernard P. Zeigler

Arizona Center for Integrative Modeling and Simulation, U. Arizona, Tucson, AZ, U.S.A.  
RTSync Corp Phoenix, AZ, U.S.A.

Keywords: System of Systems, Coordination of Activities, Healthcare Coordination, DEVS Modeling and Simulation.

Abstract: US healthcare, the most expensive in the world, has been diagnosed as an assemblage of uncoordinated component systems embedded in a market economy that promotes independent pricing with few points of global control over delivered quality of care and cost. Stimulated by the Affordable Care Act and other initiatives, efforts are underway to increase the level of information technology (IT) to improve patient record keeping and portability as well as to price services based on performance rather than amount provided. Yet such an IT infrastructure by itself will not provide significantly greater component coordination since it does not provide transparency into the threads of transactions that represent patient treatments, their outcomes, and total costs. In the traditional formulation of the coordination problem, the goal of the system-of-systems conflicts with those of its components. In contrast, our concern here is the coordination of activities among disconnected provider systems to deliver the appropriate services to an individual client. In this paper, we discuss the Pathways Coordination model, a generic construct that enforces threaded distributed tracking of individual patients experiencing certain pathways of intervention, thereby supporting coordination of care and fee-for-performance based on end-to-end outcomes. DEVS-based Modeling and Simulation methodology is discussed as the means to design, simulate, and implement such client-based coordination in systems engineering.

## 1 HEALTH CARE REFORM – A SYSTEM OF SYSTEMS COORDINATION PROBLEM

An AHRQ/NSF workshop (AHRQ/NSF,2009) envisioned an ideal health care system that is unlike today's fragmented, loosely coupled, and uncoordinated assemblage of component systems. The workshop concluded that, "An ideal (optimal) health care delivery system will require methods to model large scale distributed complex systems." Improving the health care sector presents a challenge in that the optimization cannot be achieved by sub-optimizing the component systems, but must be directed at the entire system itself. Reforming such a system requires methods to model large scale distributed complex systems using net-centric systems of systems engineering approaches (Jamshidi 2008, Mittal et al., 2012, PCAST 2014). Porter and Teisberg (2006) advocate radical reform of health care that requires that physicians re-organize themselves into Integrated Practice Units (IPUs) moving away from care that is

currently based on specialties with associated hospital departments. An IPU is centred on a medical condition defined as an interrelated set of patient medical circumstances best addressed in an integrated way. Distinct from such *clinical* care is *extra-clinical* care – the care needed outside the hospital. People with multiple health and social needs are high consumers of health care services, and are thus drivers of high health care costs. The ability to provide the right information to the right people in real time requires a *system-level* model that identifies the various community partners involved and rigorously lays out how their interactions might be effectively coordinated to improve care for the neediest patients that cost the most.

A useful abstraction comprehends the healthcare system as an interaction of individual patients, a variety of care providers, a set of payers, and a billing system that records patient-provider transactions and enables payer-provider fee-for-service transactions. Stimulated by the Affordable Care Act and other initiatives, efforts are underway

to increase the level of information technology (IT) to improve patient record keeping and portability as well as to price services based on quality of service rather than amount of service provided. Yet such an IT infrastructure by itself will not provide significantly greater coordination since it does not provide transparency into, and management of the threads of transactions that represent patient treatments, their outcomes, and total costs.

Healthcare has been compared to manufacturing with the idea that many of the same techniques can be transferred to it. However, complex patient flows, numerous human resources, dynamic evolution of patient's health state motivated Augusto and Xie (2014) to develop Petri-net-based software for modeling, simulation, and activity planning and scheduling of health care services. Their goal was to provide a mathematical framework to design models of a wide range of medical units of a hospital in order to model and simulate a wide range of healthcare services and organizations and to support such design with a Unified Modeling Language (UML) / business process modeling (BPM) interface for decision-makers. In contrast, our concern here is not within the hospital but at the System-of-Systems (SoS) level where hospitals interact with other components such as physicians, community workers, social services and health plan payers.

At the SoS level, care coordination/ is the organization of care activities among the individual patient and providers involved in the patient's care to facilitate the appropriate delivery of health care services. Craig et al. (2011) present a care coordination framework aimed at improving care at lower cost for people with multiple health and social needs. Although such a framework provides a starting point, it does not afford a rigorous predictive model that takes account of emerging health information networks and electronic medical records. The Pathways Community HUB Model is a delivery system for care coordination services provided in a community setting (AHRQ, 2011). The model is designed to identify the most at-risk individuals in a community, connect them to evidence-based interventions, and measure the results (Zeigler et al. 2014). Community care coordination works at the SoS level to coordinate care of individuals in the community to help address health disparities including the social barriers to health. The Pathways Community HUB model is a construct that enforces threaded distributed tracking of individual clients experiencing certain pathways of intervention, thereby supporting coordination of

care and fee-for-performance based on end-to-end outcomes. As an essential by-product, the Pathway concept also opens up possibilities for system level metrics that enable more coherent transparency of behavior than previously possible, therefore greater process control and improvement re-engineering,

The objective of this paper is to present a concept of *Coordination Model* that abstracts essential features of the Pathways Community HUB Model so that the kind of coordination it offers can be appreciated, and employed, in a general SoS context. This will allow us to develop a Modeling and Simulation (M&S) framework to design, test, and implement such coordination models in a variety of SoS settings, exemplified by healthcare, that present the issues that such coordination models address. We discuss the associated concepts and show how the Discrete Event System Specification (DEVS) formalism is an appropriate vehicle for their representation and implementation in the MS4 Modeling and Simulation Environment (Zeigler and Sarjoughian, 2013). We close with comments on how the environment and tools can play a role in the evolution of the Pathways Coordination model as it is applied to healthcare and other settings.

## 2 SYSTEM THEORY AND SYSTEM-OF-SYSTEMS (SOS)

We begin with a brief review of systems theory, systems-of-systems, and DEVS as they are relevant to the type of coordination discussed here. Application of the System of Systems Engineering (SoSE) concept to healthcare recognizes that it includes myriads of stakeholders involving multiple large scale concurrent and complex systems that are themselves comprised of complex systems (Jamshidi, 2008, Wickragemansighe, et. al, 2008.) Systems theory, especially as formulated by Wymore (Ören and Zeigler, 2012), provides a conceptual basis for formulating the coordination problem of interest here. Systems are defined mathematically and viewed as components to be coupled together to form a higher level system, the SoS.

### 2.1 Wymore's Mathematical System Framework

As illustrated in Figure 1, Wymore's (1967) systems theory mathematically characterizes:

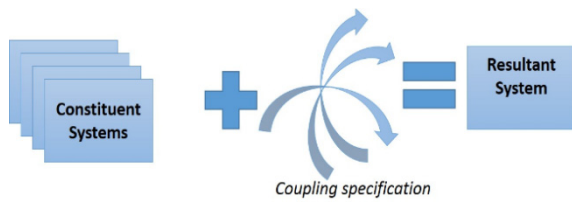

Figure 1: Wymore's System Theory

*Systems* as well defined mathematical objects characterizing “black boxes” with structure and behavior.

*Composition of Systems* – constituent systems and coupling specification result in a system, called the resultant, with structure and behavior emerging from their interaction.

*Closure under coupling* – the resultant is a well-defined system just like the original components.

## 2.2 System-of-Systems

As illustrated in Figure 2, a System of Systems (SoS) is a composition of systems, where often component systems have legacy properties e.g., autonomy, belonging, diversity, and emergence (Boardman and Sauser, 2006). In this view, an SoS is a system with the distinction that its parts and relationships are gathered together under the forces of legacy (components bring their pre-existing constraints as extant viable systems) and emergence (it is not totally predictable what properties and behavior will emerge.) Here in Wymore’s terms, *coupling* captures certain properties of relevance to coordination, e.g., connectivity, information flow, etc. *Structural and behavioral properties* provide the means to characterize the resulting SoS, such as fragmented, competitive, collaborative, coordinated, etc.

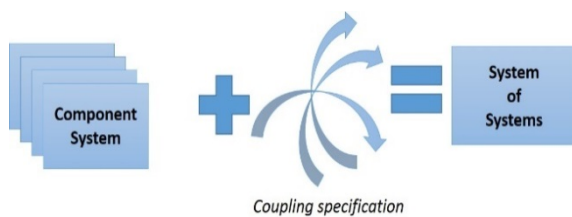

Figure 2: System of Systems.

In the traditional formulation of the coordination problem, each system has a goal and often the goal of the SoS conflicts in part with those of the components. Coordination is then conceived as a mechanism to achieve optimal alignment of component goals to the overall goal (Mesarovic,

1970). In contrast, as mentioned above, our concern here is the organization of activities among individual clients and service providers to coordinate the appropriate delivery of services. Although salient in healthcare, this concept of coordination is applicable to many situations where multiple providers offer multiple services to multiple clients.

## 2.3 Discrete Event Systems Specification (DEVS) Modeling and Simulation Framework

The DEVS formalism (Zeigler, Kim and Praehofer, 2000), based on systems theory, provides a framework and a set of modeling and simulation tools to support Systems concepts in application to SoSE (Mittal et al, 2008). A DEVS model is a system-theoretic concept specifying inputs, states, outputs, similar to a state machine. Critically different however, is that it includes a time-advance function that enables it to represent discrete event systems, as well as hybrids with continuous components, in a straightforward platform-neutral manner. DEVS provides a robust formalism for designing systems using event-driven, state-based models in which timing information is explicitly and precisely defined. Hierarchy within DEVS is supported through the specification of atomic and coupled models. Atomic models specify behavior of individual components. Coupled models specify the instances and connections between atomic models and consist of ports, atomic model instances, and port connections. The input and output ports define a model’s external interface, through which models (atomic or coupled) can be connected to other models.

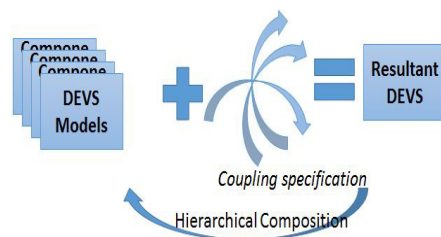

Figure 3: DEVS Formulation of Systems-of-Systems.

As illustrated in Figure 3, based on Wymore’s systems theory, the DEVS formalism mathematically characterizes:

*DEVS Atomic and Coupled Models* specify Wymore Systems.

*Composition of DEVS Models* – component DEVS and coupling result in a Wymore system, called the resultant, with structure and behavior emerging from their interaction.

*Closure under coupling* – the resultant is a well-defined DEVS just like the original components.

*Hierarchical Composition* – closure of coupling enables the resultant coupled models to become components in larger compositions.

## 2.4 Client-Oriented Coordination of Cross-System Transactions

In the kind of coordination considered here, there are multiple service providers (component systems) whose activities must be brought together in different ways to serve different clients. In the as-is situation, a client is to a large extent responsible for selecting, sequencing, and scheduling encounters with providers. Since multiple activities are located in different component systems, the client needs to traverse several activities across different systems to complete a *cross-system transaction*. Thus an adequate coordination model is characterized by the following requirements:

- Coordination design must define cross-system transitions and criteria for their successful completion,
- One or more cross-system transactions may be assigned to a client
- A coordination agent must aim to assure that clients will successfully complete their assigned transactions
- Coordination tracks the completion state and provides accountability for success/failure of the client and coordination agent in completing assigned transactions
- Coordination tracks the cost of cross-system transaction by accumulating the costs of activities involved in it.

## 2.5 Pathways as Coordination Models

Viewed as coordination models as just defined, Coordination Pathways provide concrete means to:

- Define steps in terms of goals and subgoals along paths to complete cross-system transactions
- Test for achievement and confirmation of pathway goals and subgoals

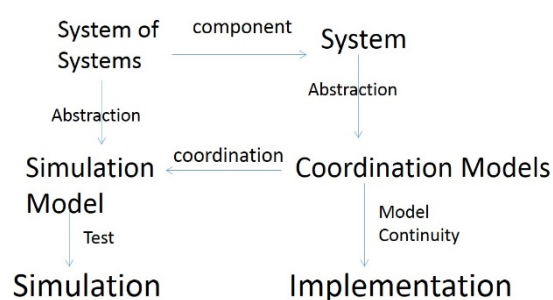

Figure 4: Methodology for Coordination Systems Engineering.

- Track, and measure progress of, clients along the pathways they are following
- Maintain accountability of the compliance/adherence of the individual and responsible coordination agent

An information technology implementation of such Pathways can provide abilities to:

- Query for the state of a client on a pathway
- Query for population statistics based on aggregation of pathway states for individuals
- Support Time-Driven Activity-based costing (Kaplan and Anderson, 2004) based on pathway steps and their completion times.

## 3 M&S METHODOLOGY FOR COORDINATION MODELING

A methodology for coordination systems engineering follows along the lines of net-centric system of systems engineering with DEVS-based modeling and simulation methodology (Zeigler and Sarjoughian, 2013, Mittal et al. 2012.) As illustrated in Figure 4, an SoS can be abstracted to a simulation model which can be used to test the developed coordination models. Such models can be derived by abstracting the features (activities, services, etc.) of the component systems that are relevant to defining coordination pathways for cross-system transactions of interest. Then after virtual testing in the SoS simulation, the same pathway models can be implemented in net-centric information technology using the model-continuity properties of the DEVS framework (which allows simulation models to be executed in real-time as software by replacing the underlying simulator



engine.) The following sections are in tune with this approach.

## 4 DEVS FORMALIZATION OF COORDINATION PATHWAYS

Formalization provides a firm basis for capitalizing on the transparency that is afforded by the Pathways Community HUB Model which enforces threaded distributed tracking of individual clients experiencing Pathways of intervention. Zeigler et al. (2014) represented such pathways as DEVS Atomic Models with implementation in the form of an active calendar that combines event-based control (Zeigler, 1989), time management, and database capabilities. Here we will specify more precisely the coordination pathway models just defined as a subclass of DEVS models. Further, such DEVS Pathways can become components of coupled models thereby enabling activation of successors and sharing of information. Zeigler et al. (2014) represented steps in a Pathway as states in its associated atomic model. Such a representation can constrain steps to follow each other in proper succession with limited branching as required; external input can represent the effect of a transition from one step to next due to data entry. Moreover, temporal aspects of the Pathways, including allowable duration of steps can be directly represented by the DEVS atomic model's assignment of residence times in states.

### 4.1 Atomic Pathways Models

Three aspects of Atomic Pathway models to note are:

- *Their primary role* is to request and receive data about a main goal and benchmarks (or subgoals) accomplishment – we will call these Questions and Answers
- *Bounded times* are given for answers to be received
- *Accomplishment of the main goal is decidable after a finite time* in the sense that the model is guaranteed to wind up (and remains) in one of three classes of states: *known success, known failure, or incomplete*. In the last type, the model explicitly states that it is unknown whether the goal has been achieved or not.

An example of an Atomic Model representing a Pathway with one goal (Figure 5) starts in state WA

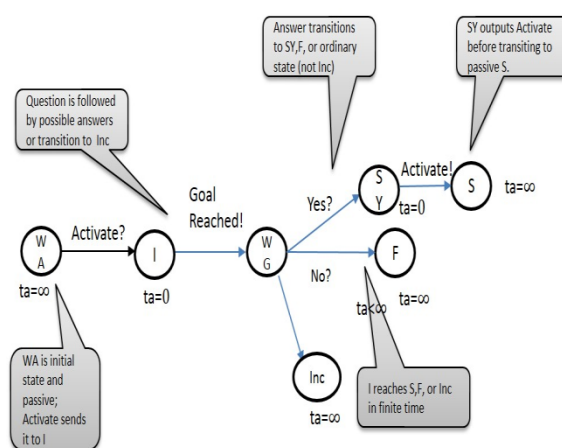

Figure 5: A Single Question Pathway Atomic Model.

(for waitForActivate) which is passive (its time advance,  $t_a$  is infinity). When an Activate is received (input ports are noted by ?, output ports by !), the model transitions to the Initialization state, I, which is a transient state ( $t_a = 0.$ ) This state immediately outputs the question, GoalReached and transitions to the state WG (waitForGoal.) In this state, the model can receive answers Yes or No and eventually enter passive states S (Success) and F (Failed) resp. (S is entered after an Activate output is generated from state SY.) However, WG has a finite time advance, so that it transitions to states Inc (incomplete) if it does not receive one of the Yes or No answers within this interval. Since Inc is a passive state, it is easy to see that, as required, this simple model always winds up (and remains) in one of the three states S, F or Inc.

### 4.2 Example Measurement Application

To illustrate an example of such a one goal pathway, we consider an application to the medical heart condition known as stroke. An input event is the arrival of a patient with a possible stroke, at the door of an emergency room. We employ the formulation of “time lost is brain lost” of Toussaint (2010) The goal is that the time from door to the start of IV tPA (intravenous infusion blood clot breakdown agent) be under 60 minutes. In Figure 5, this means that the Activate port is triggered by arrival of the patient at the door, the associated question is whether IV tPA has been started, and the time advance for the WG state is 60 minutes. Thus the Yes input signifies infusion started before 60, hence success. The input No arriving before 60 definitely indicates that the infusion will not be started in time hence failure (this could happen if a

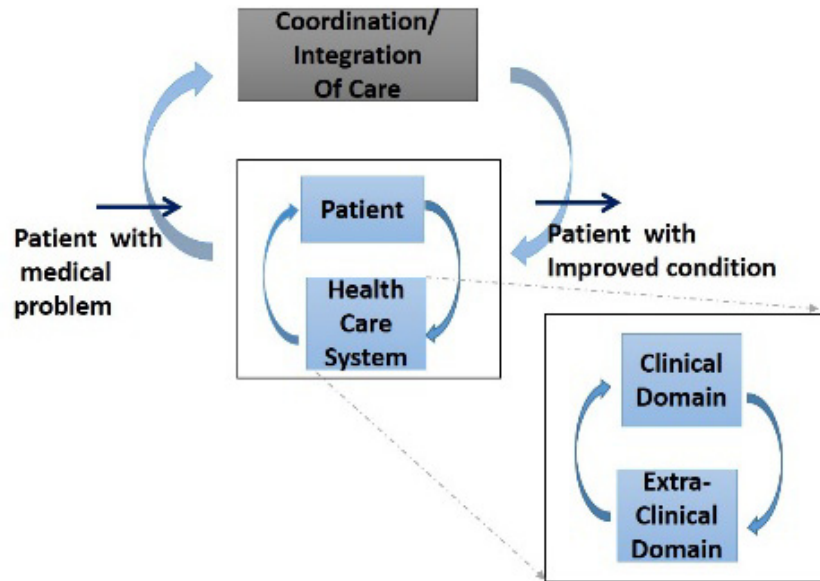

Figure 6: Health Care System Model.

subgoal such as taking a CAT scan failed due to malfunction (see later discussion). Transition to the Inc state indicates that information on the start of the infusion did not arrive within the allowed time.

The general pathway atomic model has states like WG for outputting questions and receiving answers except that transition to an incomplete state is optional. This will be illustrated in later discussion. Nevertheless, the requirement for finite time is enforced so that eventually the accomplishment of the main goal is known to be true, false, or explicitly stated to be incomplete.

In Figure 6, the system-level model of healthcare starts with a top down decomposition in which a model of a Coordinated Care System (CCS) is coupled with a Measurement System component that monitors for arrival of patients with medical conditions and other external events and evaluates the resulting outcomes produced by the CCS. To consider the Measurement System component we need to discuss coupled pathway models.

### 4.3 Coupled Pathways Models

Coupling atomic pathway models enables us to coordinate the behavior of multiple concurrent pathways. For simplicity here, coupling will be limited to activations by one pathway of one or more others. DEVS closure under coupling will assure that the resultant is a DEVS model. More than that, we can show that the resultant is also expressible as an atomic pathway model, establishing closure under coupling when restricted

to the subset of DEVS defined as pathway models. The following property is essential to such closure:

*Finite Termination Property:* For any pathway model, there is a finite time  $T$ , such that the model or all its components reach, and passivate, in any one the three types of states: Success, Failed, or Incomplete within time  $T$  after initialization.

The Appendix proves the Finite Termination Property underlying closure of coupling.

### 4.4 Comparing Coordinated Care and Traditional Clinical Pathways

Many of the features discussed above are common to both coordinated care and clinical pathways (Zeigler et al. 2014). However, coordinated care pathways are focused on accomplishment of steps, with associated accountability and payment schemes. Consequently, they specify tests for accomplishment and time bounds within which such tests must be satisfied. While clinical pathways are procedure oriented (i.e., tend towards increased granularity in describing clinical processes), care coordination pathways are more declarative (i.e., tend toward specification of goals and sub-goals rather than procedures for achieving them). Moreover, the underlying intent of Pathways are quite different in two essential dimensions: **accountability** and **basis of payment**. In a protocol, accountability is not in a specific sense taken into consideration. If the patient does not show for follow-up appointments or the medication

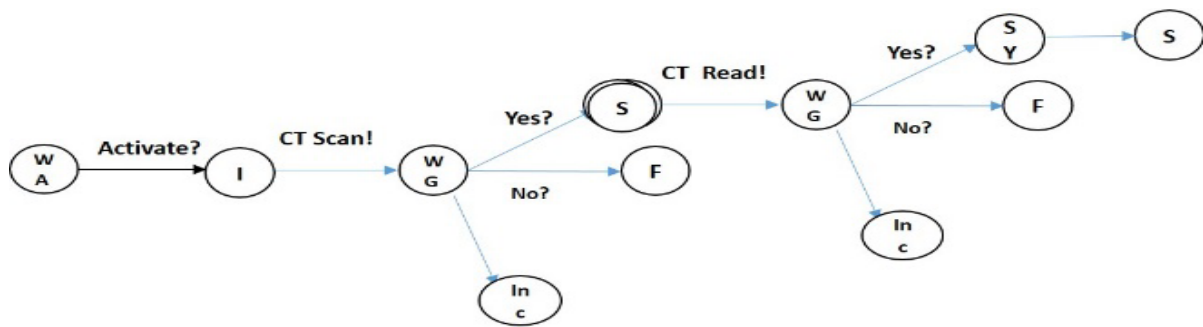

Figure 7: Atomic Pathway for "time lost is brain lost".

isn't being taking correctly, then the provider is not held accountable as long as he/she followed the protocol. This is not the case in a Pathway. The Pathway is not considered complete until an identified problem is successfully resolved. Conversely, at some definitive point, a Pathway that has not been successfully completed must be closed in a documented fashion. Moreover, as indicated above, coordinated care Pathways are associated with payment for specific benchmarks along the pathway with the highest payment provided for successful outcomes at completion, thereby linking payments to accomplishments.

## 5 PATHWAYS-BASED MEASUREMENT

To apply the DEVS formalization of pathways to measurement of goal achievement within deadlines, we use the MS4 modeling and simulation environment (ms4systems.com) to develop a simulation model that enables design, exploration, simulation and optimization. In Figure 6, the Measurement System follows a patient starting with his/her initial doctor visit or emergency room appearance through interaction with an array of services in the CCS. The Measurement System tracks a) patients' health status as they progress through pathways in service care, and b) accumulating the cost of care (tests, medications, human care managers and providers) including cost of readmissions to hospitals' regular and emergency departments.

### 5.1 DEVS Pathways Implementation for the Measurement System

Porter's Outcome Measurement Hierarchy (Porter 2010) provides a comprehensive basis for the

measurement system. Before discussing it in more detail we prepare the groundwork by continuing the discussion of the model of "time lost is brain lost" above. We employ the DEVS pathway representation for the Measurement System along the lines of Porter's Outcome Hierarchy design approach. We define a comprehensive set of outcome dimensions, and specific measures based on the event-based experimental frame methods implementable using DEVS.

***Following the Pathways Coordination Model, this will allow tracking patients through the full cycle of care to accumulate actual costs of care (not how they are charged, currently in arbitrary fashion).***

The approach starts with the simplest, yet meaningful, example of DEVS measurement system. In the application to stroke, the activation event is the arrival of a patient at the door and the goal is that the infusion of the blood clot breakdown agent, IV tPA start before 60 minutes have elapsed since the patient's arrival. The measurement system must support detecting the events of patient arrival and infusion occurrence and increment the count of goal success if, and when, it does. The output is the measure of success – percent of patients receiving the injection in time. Figure 8 shows a coupled model in which the atomic pathway model for "time lost is brain lost" sends Success or Failed outputs to an Accumulator model which counts patients and percent of successful infusion of IV tPA before 60 minutes. Figure 8 shows the Accumulator as an atomic model in the State Design graphical form supported by MS4 Me. Note in this approach we count Inc output as Failed. Zeigler et al (2014) discuss the inclusion of Incomplete in the counts of outputs and the effects this has on the choice of metrics of interest.

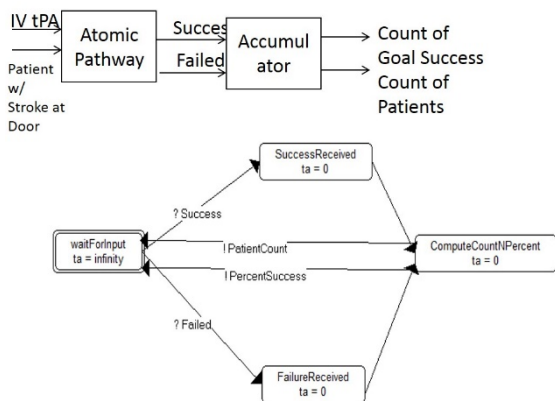

Figure 8: Measurement of Pathway Outcomes

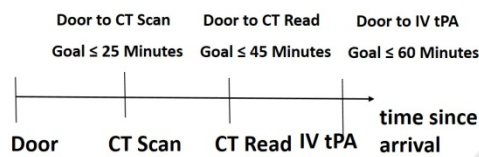

Figure 9: Subgoals for the door-to-IV tPA process.

## 5.2 Alternative Architectures for Sub-goal Tracking

Sub-goals for the door-to-IV tPA process are formulated based on critical points in the process in which a CAT Scan is taken, read and interpreted. As illustrated on the timeline in Figure 9, the subgoals CT Scan and CT Read were established with benchmarks of 25 and 45 minutes expiration from arrival at the door (Toussaint, 2010) Note that the Scan and Read measures are process measures not outcomes of direct interest to the patient but that can help the organization meet its overall goal. Figure 7 also depicts an atomic pathway model with states for CT Scan and CT Read subgoals where the Scan must happen within 25 minutes and the Read must take place within 20 minutes later for success. Extending the model with a state for the goal of IV tPA infusion would complete it.

The single atomic model, and its variations, is one possible realization of measurement for the door-to-IV tPA process. Coupled model alternatives are sketched in Figure 10. Here the components are pathway models for the individual subgoals and goal: CT Scan, CT Read, and IV tPA, resp. These components can be coupled in series or in parallel as illustrated. The atomic model and coupled model alternatives for realization of the measurement can be considered as alternative architectures available to explore as design options for implementation. In the parallel case, each of the times is measured from

the arrival event at the door while in the sequential case, these times are relative to the time of the earlier stage completion. Thus the former allows independent, less error prone, measurement while the latter may be more natural to implement since it conforms to the care delivery pathways.

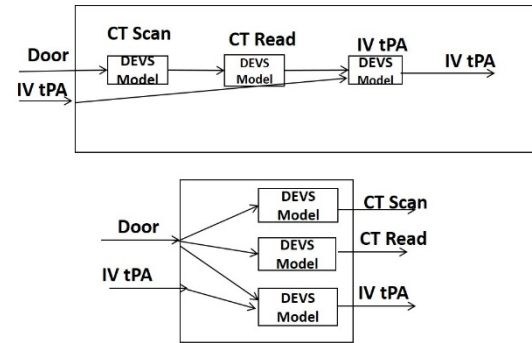

Figure 10: Alternative Coupled Models for Multiple Pathways.

Bradley et al. (2006) researched strategies to reduce door-to-balloon time in Acute Myocardial Infarction (AMI) including a time based goal of expecting staff to arrive in the catheterization laboratory within 20 minutes after being paged and the catheterization laboratory to use real-time data feedback. They found that despite the effectiveness of these strategies, only a minority of hospitals surveyed were using them- perhaps indicating the need for further automation such as the current approach can provide. The three alternative architectures for what might be called Door-to-critical-intervention can be represented as specializations in a System Entity Structure (Zeigler and Sarjoughian, 2013) and can be selected as appropriate for different medical conditions. For example, a heart attack (AMI) implementation might use only a single atomic pathway model to measure door-to-balloon times and survival rates. In contrast, a stroke implementation might employ one of the sequential or parallel alternative architectures for its time-lost-is-brain-lost interventions.

## 5.3 Example: Coordinated HIV-AIDS Care System Model

The continuity spectrum of HIV-AIDS intervention spans HIV diagnosis, full engagement in care, receipt of antiretroviral therapy, and achievement of complete viral suppression (Figure 11). However, Gardner, et al., (2011) estimate that only 19% of HIV-infected individuals in the United States have been treated to the point where their virus is



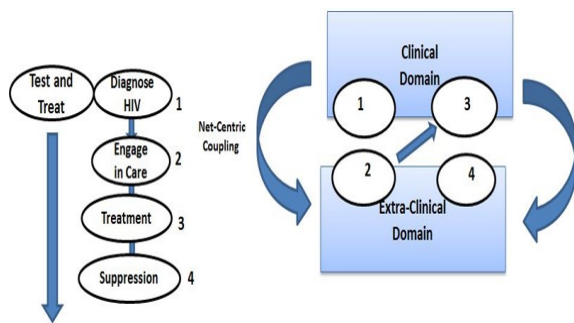

Figure 11: HIV-AIDS Continuity of Care Pathway Model.

undetectable. This occurs because achievement of an undetectable viral load is dependent on overcoming the barriers posed by patients “falling through the cracks” in traversing each of the sequential stages shown in Figure 11. The authors conclude that recognition of the “pipeline” and support for successful handoff of patients from stage to stage is necessary to achieve a substantial increase in successfully treated HIV population. Figure 11 depicts the stages of care continuity roughly assigned to both clinical and extra-clinical domains and that they alternate between the two domains (shown cycling from 1 to 4).

Coordination of the clinical and extra-clinical domains is consistent with the multi-level framework for coordination within and across organizations (Gittell and Weiss, 2004). This framework identifies key dimensions that can be altered within and across organizations to enable or improve communication and coordination. Such dimensions include structure of the organization, knowledge and technology employed, and administrative operational processes and were found to be effective in enhancing information exchange, alignment of goals and roles, and improved quality of relationships (Van Houtd, 2013). Here we consider the approach of formulating the DEVS Pathways discussed above for stages 1 and 3 to form an Integrated Practice Unit. Also DEVS pathways are proposed for stages 2 and 4 which are similar to those of the Pathways Community HUB. Using a DEVS coupled model, the clinical domain pathways are interfaced to the extra-clinical ones. The objective is that patients are handed-off from one DEVS Pathway to the next without being dropped from care. Such cross-organization care pathways require sufficient electronic health record system and health information technology networking support to track and monitor patients as they traverse the treatment pipeline. Recall that this will require definition of

goals and subgoals along paths to complete cross-system transactions, testing for achievement and confirmation of pathway goals and subgoals, tracking, and measuring progress of, patients along the pathways they are following, and maintaining accountability of compliance and adherence. The implementation of such IT can then provide a “dashboard” for viewing the overall disposition of patients through the complete cycle of continuity of care required for successful HIV-AIDS treatment.

## 6 ACTIVITY-BASED CONTINUOUS IMPROVEMENT

DEVS Pathways enable Time-Driven Activity-based costing (Kaplan and Anderson, 2004) based on pathway steps and their completion times. In this regard, Muzy et al. (2013) identify three layers of an adaptive system applicable to continuous improvement of individual-based coordinated care systems:

1. *Time-Driven Activity-Based Costing* using a built-in measurement system.
2. *Activity Evaluation and Storage*: using the built-in detection mechanisms of level 1, activity can be measured as the fractional time that a component contributes to the outcome. Correlating contribution with outcome, a credit can be attributed to components. Such a measure of performance of components can be memorized in relation to the experimental frame, or context, in which it obtained.
3. *Activity awareness*: feedback of the activity-outcome correlation to the inform the decision-making process of which components or their variations to apply overall or to the current problem.

Muzy and Zeigler (2014) describe a system that implements these layers in an example simulation experiment. Pathway coordination models lend themselves to support critical features of such learning systems. A pathway keeps track of individuals’ traversal through the SoS As a DEVS model, activity of a pathway over a time interval is measured by the number of state transitions that occurred in the interval (see (Zeigler et al. 2014) for details.) The activity of the overall system is estimated by the aggregation of all individual pathway activities. When activity is aggregated over all individuals that traversed a component, we get an estimate of the component’s activity. These

measures can be sub-indexed by pathway to rank the overall system activity from most active to least active pathway, thereby providing insight into how the system is being utilized. Further sub-indexing by factors such as condition treated, patient attributes, source of client referral, enable analysis of the variation due to such factors. Moreover, since pathways include outcome measurement they enable correlation of activity and outcome for each individual. Aggregation over individual traversals of components yields component performance outcome measures. Components or variants that do not perform well in this measure are candidates for replacement by other alternatives that can replace them. Such activity-based outcome correlation and feedback exhibits the continuous improvement characteristic of an evidence-based learning healthcare system advocated by Porter and others.

## 7 SUMMARY AND CONCLUSIONS

The discussion presented can be summarized in the following points:

- Health Care Reform is usefully viewed as a System-of-Systems Engineering Problem.
- Coordination of healthcare was formulated as an instance of Coordination Models defined as client-oriented coordination of cross-system transactions within a system-of-systems.
- Coordination Models were formalizing using Pathways expressed in the DEVS modeling and simulation formalism.
- The MS4 Modeling and Simulation Environment based on DEVS supports design, testing, and implementation of Coordination Pathways in a systems engineering approach.

The President's Council on Science and Technology (PCAST ,2014) advocates increased use of systems engineering in healthcare: "While there are excellent examples, systems methods and tools are still not used on a widespread basis through health care." The Systems of Systems Engineering formalization and simulation modeling methodology presented here will enable DEVS Coordination Pathways to see wider use in re-engineering of healthcare delivery systems. Layering such models on top of the emerging health data infrastructure will enable development of system level metrics and analytics that will enable healthcare to become a global learning system.

## ACKNOWLEDGEMENTS

This material is based upon work supported by the National Science Foundation under Grant Number CMMI-1235364. Any opinions, findings, and conclusions or recommendations expressed in this material are those of the author(s) and do not necessarily reflect the views of the National Science Foundation. I acknowledge the essential intellectual support of E. L. Carter, S. A. Redding, B. A. Leath, and C. Russell who constituted the research team in this project. I also acknowledge the essential technical support of Dr. Chungman Seo, Mr. Wantae Kang, and Mr. Keneth Duncan who were essential in performing the modeling, simulation, and implementation of pathways coordination implementation. We greatly appreciate the help of Drs. Mark and Sarah Redding, the originators of the Communication HUB Pathways concept, in its formalization.

## REFERENCES

- AHRQ, 2011. Connecting Those at Risk to Care: The Quick Start Guide to Developing Community Care Coordination Pathways. [http://www.innovations.ahrq.gov/guide/QuickstartGuide/CommHub\\_QuickStart.pdf](http://www.innovations.ahrq.gov/guide/QuickstartGuide/CommHub_QuickStart.pdf).
- AHRQ/NSF, 2009. "Industrial and Systems Engineering and Healthcare: Critical Areas Workshop, September 21-22, 2009 workshop was co-sponsored by the Agency for Healthcare Research and Quality
- Augusto Vincent and Xiaolan Xie, 2014. A Modeling and Simulation Framework for Health Care Systems, IEEE Transactions on Systems, Man, and Cybernetics: Systems, Volume:44 , Issue: 1, 30 – 46
- Boardman, J., and Sausser, B. ,2006. System of Systems – the meaning of "of". IEEE/SMC International Conference on System of Systems Engineering. Los Angeles, CA: IEEE.
- Bradley Elizabeth H. et al. 2006 Strategies for Reducing the Door-to-Balloon Time in Acute Myocardial Infarction, N Engl J Med; 355:2308-2320 November 30, 2006 DOI: 10.1056/NEJMsa063117
- Craig C and D, Whittington, 2011. J. Care Coordination Model: Better Care at Lower Cost for People with Multiple Health and Social Needs. IHI Innovation Series white paper. Cambridge, Massachusetts: Institute for Healthcare Improvement;. (Available on [www.IHI.org](http://www.IHI.org))
- de Bleser L., R. Depreitere, K. de Waele, K. Vanhaecht, J. Vlayen and W. Sermeus, 2007. "Defining pathways," J Nurs Manag, vol. 14, pp. 553-63,

- Gardner Edward M., et al., 2011. The Spectrum of Engagement in HIV Care and its Relevance to Test-and-Treat Strategies for Prevention of HIV Infection . Oxford Journals Medicine Clinical Infectious Diseases Volume 52, Issue 6 Pp. 793-800
- Gittell, JH and Weiss SJ. 2004.Coordination networks within and across organisations: a multilevel framework. J Management Studies, 41.(1):127–153.
- Jamshidi, Mo, 2008. Systems of Systems – Innovations for the 21st Century, Wiley,
- Mesarovic, Mihajlo D. , D. Macko and Yasuhiko Takahara 1970. Theory of Multi-level Hierarchical Systems. Academic Press.
- Mittal, Saurabh and José L. Risco-Martín , 2012. DEVS Net-Centric System of Systems Engineering with DEVS Unified Process. CRC-Taylor & Francis Series On System Of Systems Engineering,
- Mittal, Saurabh, Bernard P. Zeigler, Jose L. Risco Martin, Ferat Sahin and Mo Jamshidi, 2008. Modeling and Simulation for Systems of Systems Engineering, Systems of Systems -- Innovations for the 21st Century, Edited by Mo Jamshidi, Wiley, , pp. 101-149
- Muzy Alexandre and Bernard P Zeigler, 2014. “Activity-based Credit Assignment Heuristic for Simulation-based Stochastic Search in a Hierarchical Model-base of Systems”, submitted to IEEE Systems Jnl
- Muzy, Alexandre et al., 2013. “Refounding of activity concept? Towards a federative paradigm for modeling and simulation”, in SIMULATION Volume 89 Issue 2, February
- Ören, Tuncer I. and B. P. Zeigler, 2012. “System Theoretic Foundations of Modeling and Simulation:A Historic Perspective and the Legacy of A. Wayne Wymore”, SIMULATION/ September vol. 88 no. 9 1033-1046
- Ozcan, Yasar A.; Tãnfani, Elena; and Testi Angela. 2011. A simulation-based modeling framework to deal with clinical pathways. Proceedings of the 2011 Winter Simulation Conference. S. Jain, R.R. Creasey, J. Himmelspach, K.P. White, and M. Fu, eds.
- Porter, Michael E., 2010. “ Measuring Health Outcomes”, New England Journal Of Medicine, December
- Porter, Michael E. and Teisberg, Elizabeth Olmsted, Redefining Health Care: Creating Value-based Competition on Results, Harvard Business Review Press; 1 edition (May 25, 2006)
- PCAST ,2014. President’s Council of Advisors on Science and Technology Report To The President Better Health Care And Lower Costs: Accelerating Improvement Through Systems Engineering, [http://www.whitehouse.gov/sites/default/files/microsites/ostp/PCAST/pcast\\_systems\\_engineering\\_in\\_healthcare\\_-\\_may\\_2014.pdf](http://www.whitehouse.gov/sites/default/files/microsites/ostp/PCAST/pcast_systems_engineering_in_healthcare_-_may_2014.pdf) (accessed June 9, 2014)
- Seo, Chungman, Wontae Kang, Bernard P. Zeigler, and Doohwan Kim, 2014. Expanding DEVS and SES Applicability: Using M&S Kernels within IT Systems. Symposium on Theory of Modeling & Simulation – DEVS (TMS/DEVS) Spring Sim San Diego, CA, USA
- Shea, S.M. and C.E. Baker. 2013.Basketball Analytics: Objective and Efficient Strategies for Understanding How Teams Win. CreateSpace Independent Publishing Platform,
- Toussaint, John, 2010 ‘On the Mend: Revolutionizing Healthcare to Save Lives and Transform the Industry” 181 pages,: LEAN ENTERPRISE INSTITUTE; 1 edition
- Van Houdt S, Heyrman J, Vanhaecht K, Sermeus W, De Lepeleire J, 2013. Care pathways across the primary-hospital care continuum: using the multi-level framework in explaining care coordination BMC Health Services
- Wickragemansighe N., et. al., 2008. Health Care System of Systems; in: Systems of Systems -- Innovations for the 21st Century, Edited by Mo Jamshidi, Wiley, , pp. 542-550
- Wymore A. W., 1967. *A Mathematical Theory of Systems Engineering: The Elements*, John Wiley & Sons, New York, 1967.
- Zeigler BP, 1989. "The DEVS Formalism: Event-Based Control for Intelligent Systems," Proc. of the IEEE, Vol. 77, No. 1, pp. 27-80.
- Zeigler B P., Hessam S. Sarjoughian,2012.. Guide to Modeling and Simulation of Systems of Systems, Simulation Foundations, Methods and Applications, Springer.,
- Zeigler B.P., .G.Kim and H. Praehofer, 2000. Theory of Modeling and Simulation: Integrating Discrete Event and Continuous Complex Dynamic Systems, second edition with co-authors T Academic Press, Boston., 510 pages
- Zeigler, B.P., and S. A. Redding., 2014. Question and Answer Perspective on Care Coordination: Formalization of Pathways for Standardization and Certification, AHRQ Innovations Exchange Web Site, <http://www.innovations.ahrq.gov>
- Zeigler, B.P., Chungman Seo, And Doohwan Kim, 2013. System Entity Structures for Suites of Simulation Models, International Journal of Modeling, Simulation, and Scientific Computing DOI: 10.1142/S1793962313400060, Volume 04, Issue 03, September 2013
- Zeigler, B.P., E. Carter, C. Seo, C. K Russell, and B. A. Leath, 2012. Methodology and Modeling Environment for Simulating National Health Care. Autumn Simulation Multi-Conference (AutumnSim'12), October 28-31, 2012.
- Zeigler BP, Carter, EL Redding SA, Leath BA, Russell, C, 2014. Care Coordination: Formalization of Pathways for Standardization and Certification, [http://www.rockvilleinstitute.org/files/Care\\_Coordination\\_Formalization\\_of\\_Pathways\\_for\\_Standardization](http://www.rockvilleinstitute.org/files/Care_Coordination_Formalization_of_Pathways_for_Standardization)

on\_and\_Certification.pdf.(accessed April 9, 2014)  
Summarized in Innovations Exchange Team, Zeigler  
BP, Redding SA. Formalization of the Pathways  
Model Facilitates Standards and Certification  
<http://www.innovations.ahrq.gov/content.aspx?id=4097>.(accessed April 9, 2014)

Zeigler BP, Carter, EL Redding SA, Leath BA, 2014.  
Pathways Community HUB: A Model for  
Coordination of Community Health Care, accepted  
for publication in Population Health Management

## APPENDIX

### Preservation of Finite Termination Property:

Proof by induction:

Basis step: For atomic models, the property holds  
by assumption that Requirement 3 holds.

Induction step: Assume the property holds for  
coupled models with N components. Show it holds  
for coupled models of N+1 components.

Let's add a pathway model as a component to a  
coupled pathway model of size N. By assumption,  
the coupled model of size N can be considered as a  
pathway atomic model in the sense of eventually  
passivating in one of the allowable states. Consider  
transferring of activation from one atomic pathway  
model to another, This can only occur when the first  
model reaches the Success state after outputting the  
Activate. This output reaches a second pathway  
model only if a coupling exists from the Activate  
output port of the first to the Activate input port of  
the second. We now show that the second model  
will then become active if, and only if, it is in the  
WA state when this Activate is received. The "if"  
implication will be true since the model starts in the  
passive WA state and cannot be disturbed from this  
state by any input other than Activate. The "only if"  
implication holds because no other state has such an  
Activate input.

Thus, transfer of activation from one atomic to the  
second through the Activate coupling, if this occurs  
at all, will occur in a finite time after the first model  
has been activated because of the basis step. Once  
activated, an atomic pathway model will eventually  
passivate in one of the allowable states after a finite  
time, End of Proof.

## BRIEF BIOGRAPHY

Bernard P Zeigler is Emeritus Professor of  
Electrical and Computer Engineering at the  
University of Arizona and Adjunct Research  
Professor in the C4I Center at George Mason  
University. He is internationally known for his  
seminal contributions in modeling and simulation  
theory and has published several books including  
"Theory of Modeling and Simulation" and  
"Modeling & Simulation-based Data Engineering:  
Introducing Pragmatics into Ontologies for Net-  
Centric Information Exchange". He was named  
Fellow of the IEEE for the Discrete Event System  
Specification (DEVS) formalism that he invented in  
1976. Among numerous positions held with the  
Society for Modeling and Simulation International  
(SCS) he served as President and was inducted into  
its Hall of Fame. He is currently Chief Scientist  
with RTSync Corp., a developer of the MS4  
modeling and simulation software based on DEVS.  
Zeigler's research has been funded by a variety of  
sponsors including National Science Foundation  
(NSF), Defense Advanced Research Projects  
Agency, US Air Force Research Laboratory among  
others. . Currently, Zeigler is leading a project for  
the NSF and the Agency for Healthcare Research  
and Quality for the developing a simulation model  
for the national healthcare system. For more  
information see the Wikipedia entry on Bernard P  
Zeigler.