

# A Wide-band and User-friendly EEG Recording System for Wearable Applications

Lorenzo Bioni, Enzo Mastinu and Massimo Barbaro

*Department of Electrical and Electronic Engineering, University of Cagliari, Piazza d'Armi, Cagliari 09123, Italy*

**Keywords:** EEG Recorder, Wearable EEG, Wide-band EEG, Wireless, Bluetooth EEG.

**Abstract:** A wireless, wearable and non-invasive EEG recording system is proposed. The system includes a low-power 8-channel acquisition module and a Bluetooth (BT) transceiver to transmit acquired data to a remote platform. It was designed with the aim of creating a cheap and user-friendly system that can be easily interfaced with the nowadays widely spread smartphones or tablets by means of a mobile-based application. The presented system, validated through in-vivo experiments, allows EEG signals recording at different sample rates and with a maximum bandwidth of 524Hz. It was realized on a 19cm<sup>2</sup> custom PCB with a maximum power consumption of 270mW.

## 1 INTRODUCTION

The electroencephalogram (EEG) is a common technique for detecting symptoms of neurological diseases such as epilepsy, sleep disorders, anxiety and learning disabilities. These pathologies have a great impact on people common life and are quite common. For example anxiety disorders affects approximately 13.6% of the European population (Alonso J., 2004), and, in 2010, its overall cost in Europe was €74.4 billion (J. Olesen, 2012). Most of the mentioned mental disorders require long-term EEG monitoring to follow the course of the disease and sometimes to prevent further degradations of the patient condition such as epileptic discharges. In these cases the longer is the EEG measurements period the higher is the probability of a successful event detection. Moreover EEG acquisition during daily life activities is highly recommended to better reveal some pathologies.

Traditional ambulatory EEG systems do not satisfy these requirements. In fact patients can be continuously observed for only a few hours because of the costs and resource overheads. Moreover there are some inconveniences such as forcing people to take time off work and moving them from their natural environment. As a consequence, patients often feel uncomfortable and, depending on their pathology, this can affect the EEG acquisition, introducing undesired artifacts. As a result of recent technology innovations, new outpatient EEG systems were introduced. Such mobile solutions overcome some of these limitations

reducing the overall patient monitoring costs and increasing the effectiveness of the measurements (Waterhouse, 2003). Despite their benefits such systems are still cumbersome and/or too complex to be used outside hospitals and require expert assistance.

Wearable EEG is aimed to overcome these issues, allowing the recording of a longer temporal window that includes all stages of sleep and wakefulness and increasing the likelihood of recording typical symptoms. Many efforts have been already put on the realization of wearable EEG systems. Some examples are presented in (Brown L., 2010) and (Carmo J.P., 2007) in which respectively a semi-custom and a completely custom CMOS EEG recorder was realized, whereas a 4-channel BCI-cap based on off-the-shelf components is described in (Lin et al., 2008). Other examples are the Epoc (Emotiv, 2013), the Imec's headset (Patki et al., 2012) and the Quasar's (Quasar, 2013) DSI 10/20. They all use proprietary radio link for data transmission resulting in a reduced power consumption though they require specific hardware to interconnect a remote back-end. Only a few systems have been developed using a standard communication link such as the ThinkGear (NeuroSky, 2009) and the Starfast (A. Riera, 2008). Furthermore currently available EEG systems mainly operate with a bandwidth under 100Hz that may be enough to cover the most common diagnostic purposes, but a wider bandwidth, up to 600Hz, is required to investigate some pathologies (Mihajlovic et al., 2014). As fully discussed in (Mihajlovic et al., 2014), many improvements are still re-

quired in order to get a promising solution, easy to use by non-expert users in a completely uncontrolled environment. Some critical aspects that refer to the electrode-skin adherence, the battery life time and the quality of the acquired EEG signals have to be solved.

According to the idea of spreading the use of wearable EEG recorders, the system requires a low impact on people daily life. In other words the device should not imply the use of additional special equipments and it should be very practical. These requirements and the increasing spread of smartphones and tablets among a wide variety of users, from teen to elders (Smith, 2013), suggest these new generation mobiles as the best solution to control the wearable EEG recorders. Furthermore this choice is supported by recent researches on moving the telemedicine toward mobile platforms (Sapal Tachakra and Song, 2003), (Chan S.R. and P., 2014), (Lupu and Cosmin-Constantin, 2013), (El Khaddar et al., 2012).

The EEG system proposed in this paper is based on a custom PCB with off-the-shelf components (COTS) and uses a standard BT link to transmit the acquired signals. As a consequence it exhibits a higher power consumption compared to those solutions, previously presented, that use custom radio link but it has the advantage of being easily interfaced with any BT-based terminal and integrated with such new healthcare systems. In addition, today's technology allows mobile devices with high computational power, huge storage memory and fully programmable. In this way they can store and elaborate the EEG signals allowing a wide-range of applications. Anyway our EEG recorder can also be connected to a traditional desktop PCs for which a simple Microsoft Windows-based application for testing purposes was developed. Being a wearable device, special efforts were made in reducing its power consumption and in device miniaturization. As a result, only the essential components were included in the project: an amplifying/filtering block, an analog to digital converter, a micro-controller, a BT transceiver and a power management module. In the following Sec.2 the system architecture details will be described, Sec.3 contains a brief description of a possible remote interface whereas the validation test results will be presented in Sec.4. Finally systems performance and future development will be shortly summarized in Sec.5.

## 2 SYSTEM ARCHITECTURE

The designed system, named BlueThought by joining the implemented transmission link with the nature of the acquired signals, is based on a differential 8 chan-

nel recording unit. The EEG signals detected with a standard EEG cap are first amplified and then converted into digital signals by an ADS1299 component from Texas Instrument. Once acquired, digital signals are transmitted to a remote back-end by means of a Microchip Bluetooth RN-42 module. Moreover a USB connection was introduced to charge the EEG recorder battery and as additional channel for data transfer. A Microchip PIC18F46J50 coordinates data exchange between ADC and BT or USB external controller. The system architecture is depicted in Fig.1.

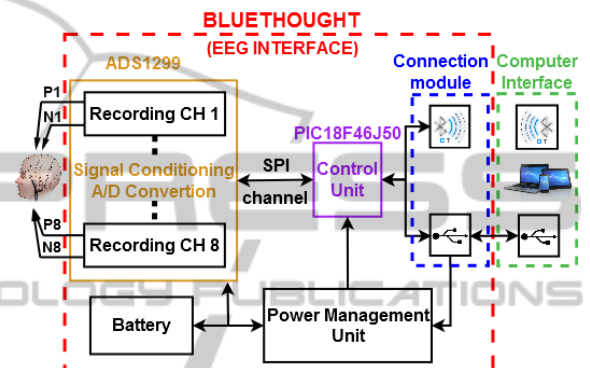

Figure 1: BlueThought: System Architecture.

In addition a power management unit generates all digital and analog voltage supplies for the ADC, the microprocessor and the BT transceiver from a 3.7V – 950mAh LiPo battery. Even the battery charging circuit was implemented on the board. The EEG recorder was realized on the 5.5cmX3.5cm double face board depicted in Fig.2. In the following further details on the main modules of the EEG recorder will be described.

### 2.1 Signal Conditioning and Digital Conversion

Before being converted into digital format, the input signals are filtered and amplified. To reduce power consumption and PCB area we decided not to insert an additional signal conditioning block but to use the one provided by the A/D converter (ADS1299). This device contains eight independent differential channels allowing simultaneous acquisition. An internal multiplexer allows to select the P and N input signals among various sources and depending on the selected signals different recording modes are possible: normal recording, test and impedance monitoring mode. The normal recording mode is the default working set-up in which EEG signals are acquired in both single-ended and differential configuration. In

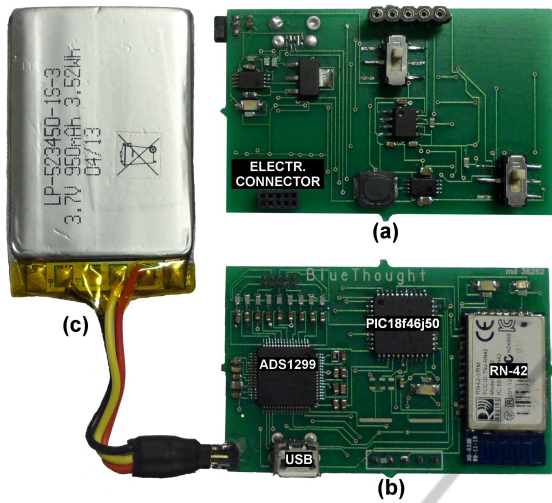

Figure 2: EEG Interface prototype: power management circuit on bottom side(a); ADS1299 (ADC), PIC18F46J50 (microprocessor), USB and RN-42 (BT transceiver) on top face(b) and a 3.7V – 950mAh LiPo battery(c).

single-ended measurements the  $N$  signals are internally shorted to the external reference (typically mid-supply voltage) or to the bias signal generated by the internal bias module on the base of a desired input signal combination. Whereas in differential measurements both P and N signals come from the EEG cap. To reduce the number of interconnections between the EEG recorder and the bonnet all  $N$  input lines are shorted together getting only one common reference electrode conveniently placed on the patient body. In test mode, different internally-generated test signals can be selected as input allowing the signal acquisition chain to be tested out. Another important feature provided by the ADS1299 is the lead-off detection. It consists in a continuous patient electrode impedance monitoring to verify if a suitable connection is present or not.

The first stage of each acquisition channel is a differential low-noise programmable gain amplifier (PGA). It offers seven gain settings (1,2,4,6,8,12, and 24) that can be set-up by writing the channel-setting registers (one per channel) of the ADS1299. As mentioned in Sec.1, our EEG recorder can acquire signals with a bandwidth wider than standard EEG monitor. In fact, as reported in Tab.1, the system supports different sample rates from 250SPS up to 2000SPS resulting in a maximum bandwidth of 524Hz. This makes our device suitable for a wide range of applications even those requiring the analysis of signals out of standard EEG frequency. After being amplified, the signal is digitalized by a 24-bit sigma delta converter. The ADC operates in two different modes: continuous mode (default) and single-shot

Table 1: EEG Recorder Output Data Rate and -3dB BW.

OUTPUT DATA RATE (SPS)	-3dB BANDWIDTH (Hz)
250	65
500	131
1000	262
2000	524

mode. In the first modality, when a start command is sent, it continuously converts the input signal. The conversion ends when a stop command is received. Whereas, if the device is in single-shot mode it generates only one sample per received start command. This means that to begin a new conversion, a new start command has to be sent. Regardless of the operating mode, as a single sample conversion ends, a data-ready signal (DRDY) is pulled down to notify the microprocessor that a new sample is ready. After being converted, the eight samples (each per channel) are packed and sent to the micro-controller over a 3MHz SPI connection. Each data packet contains 24-bit of header and 216-bit of sampled data. In the following the control unit is described. It forwards the samples received from the ADC to the BT transceiver or to the USB controller depending if a wireless or a wired connection is being used.

## 2.2 Control Unit

The Microchip PIC18F46J50 is used as control unit to serve two main tasks: system set-up and data exchange. The PIC is powered at 3.3V with a CPU clock frequency of 48MHz generated by an on-chip oscillator. At system power-up, the PIC is used to setup the EEG interface defining both recording and connection parameters such as acquisition gain and bandwidth, ADC SPI clock frequency, BT data rate and communication protocol parameters. All values are tuned to find a good compromise between the acquired EEG signal quality and the power consumption. Once that the system started to acquire the EEG signals, the control unit coordinates data exchange among the converter and BT or USB remote back-end.

The microprocessor provides several internal peripherals that, if not used, can be disabled to save power. In particular we are interested in using the USB and the UART in/out ports to respectively connect the PIC to a remote USB controller or to the BT transceiver.

Although the system communication mode can be on-line modified by the user, if, on power-up, any device is connected to the USB port, the PIC automatically enables the USB controller otherwise the

BT transceiver is turned on. Once defined the connection mode, the microprocessor starts a polling cycle waiting for data coming from the remote controller. The received commands are decoded and executed. Such commands, generally are aimed at controlling the ADC or the BT transceiver but they can also be addressed to the same microprocessor for example to setup the USB controller. The main steps of the firmware are described in the flow chart of Fig.3. Regardless of the back-end connection mode

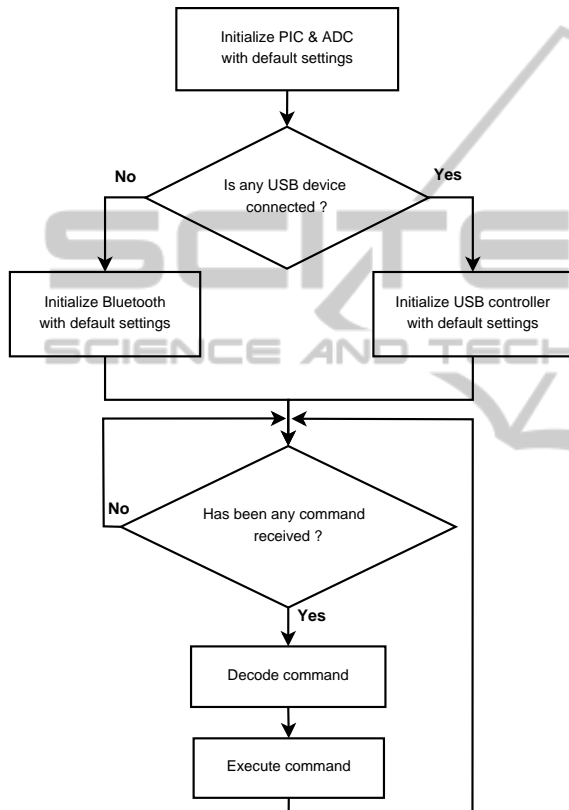

Figure 3: Main steps of the control unit firmware.

(via USB or BT) and only in single-shot recording, the same polling cycle is used by the PIC to send the sampled data to the remote controller. Otherwise, in continuous recording, sampled data transmission is handled by an interrupt service routine. The ADS1299 data-ready signal (DRDY) is connected to an interrupt sensitive pin of the PIC acting as an external interrupt. When DRDY is pulled down (i.e. new samples are available) an exception is raised and the interrupt service routing is executed. The new samples are transferred from the ADC to the microprocessor that forwards data to the remote controller. Some details about the USB and the BT connection are given in the following paragraph.

### 2.3 Data Transmission

In normal operation mode, the BT transceiver allows wireless data transmission between the EEG recorder and the remote back-end, whereas the USB controller is used for battery recharging. However, during test mode, the wired connection can be used for both data transfer and system powering. Enabling high frequency EEG recording, the ADC needs to operate at sample frequencies up to 2000SPS (see Tab.1) resulting in a maximum outputs data rate (ODR) of 54Kbyte/sec (Eq.1). This is a critical parameter to define the data-exchange channel specifications.

Single data packet: 216bit

$$\text{ODR}(@2000\text{SPS}): \frac{2000 * 216}{8} = 54\text{Kbyte/sec} \quad (1)$$

The USB port is directly handled by an on-chip USB controller and can operate in two different modalities: CDC and HID mode. To make the USB suitable for our application, a standard HID protocol was implemented. Working at full speed (48MHz) with 64-byte data packet size, the data transfer speed is limited to 64Kbytes/sec. In addition, to make the transmission more efficient, two sampled data packets (2x216bit = 432bit) are grouped in the same USB frame. As a result, in worst conditions (2000SPS), the required data transfer rate amounts to 27Kbyte/sec that is below the USB transfer rate limit.

In contrast to the USB HID protocol, the BT transceiver does not require fixed size packets, but their length is adapted to the amount of transferred data. The RN-42 is a small form factor, low power, class 2 BT radio with on-chip antenna. It delivers up to a 3Mbps data rate for distances up to 20 meters. It uses an UART port to communicate with the control unit and operates in two modes: data mode (default) and command mode. In data mode, the module works as a data pipe. When the module receives data, it strips the BT headers and forwards the data to the UART port. When data is written to the UART port, the module constructs the BT packet and sends it out over the BT wireless connection. Thus, the entire process of sending/receiving data to the host is transparent to the PIC. The command mode is used to defining the BT operating mode, the UART baud rate and others control flow parameters. Moreover the RN-42 operates in slave mode so that other BT devices (PC, tablet or smartphone) can discover and connect to the module.

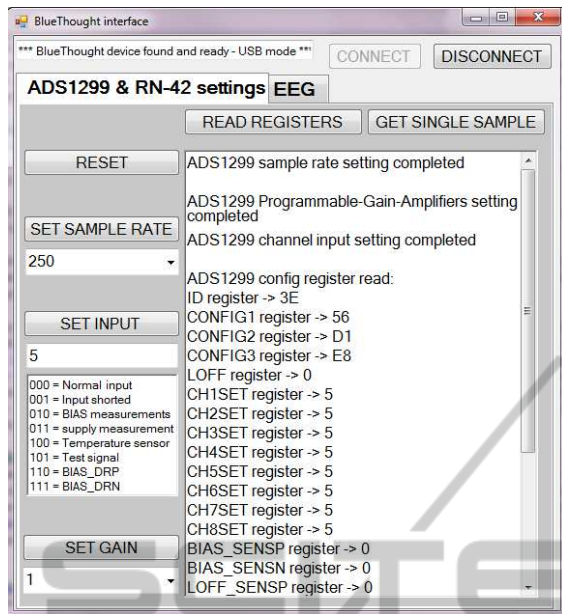

Figure 4: Visual C++ EEG interface: system setup window.

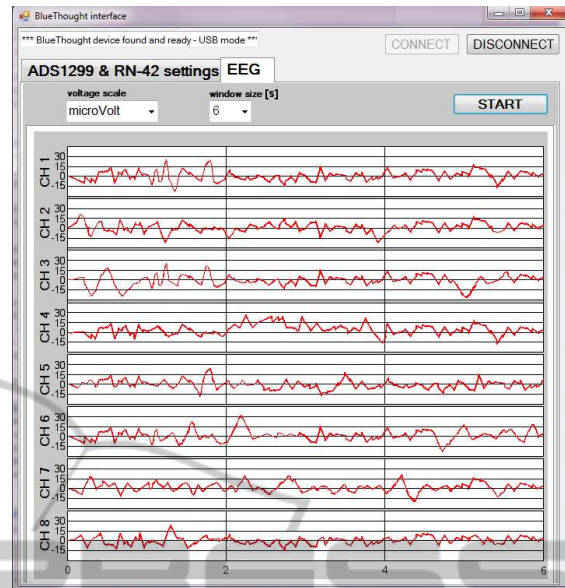

Figure 5: Visual C++ EEG interface: on-line plotting window in a  $\mu V$  amplitude scale and with a 6s temporal window.

### 3 REMOTE INTERFACE

The designed system is a general purpose EEG recorder and depending on the treated pathology a specific software can be developed. At this first stage of the project a Visual C++ application was written, implementing only the essential features for the hardware debugging. The ADC module can be completely configured in terms of PGA gain and sample rate and both continuous and single-shot modes are selectable. The eight recorded signals are plotted for a real-time view and stored in a text file for off-line data computing. Fig.4 and Fig.5 show the two main window of the developed interface. The first refers to the system settings and the second to the plotting of the eight recorded signals. For all channels is possible to setup the amplitude scale ( $\mu V$ ,  $mV$  or  $V$ ) and the temporal window size.

### 4 RESULTS

All system features were first characterized and then compared with a standard laboratory equipment. To start with its static electrical characterization, Tab.2 collects the EEG interface power consumption in different working conditions. In idle state (only the microprocessor is on) it has a minimum power consumption of about  $119mW$  whereas in worst conditions (i.e. all devices are on, sample rate of  $2000SPS$  and active BT data transmission) it absorbs a maximum of

Table 2: EEG Recorder Power Consumption in different working conditions.

Power Consumption (mW)	A/D Converter (OFF)	A/D Converter (ON)
Bluetooth (OFF)	119	158
Bluetooth (ON)	230	270

$270mW$ . Under this conditions and with the chosen battery ( $3.7V - 950mAh$  LiPo) the system can continuously work for about 13 hours. Further experiments were performed to study the dynamic behaviour of the EEG acquisition channel. Its gain programmability from  $1V/V$  up to  $24V/V$  was confirmed acquiring a  $12mV - 30Hz$  sine as depicted in the above plot of Fig.6. The device showed a  $63.5Hz - 3dB$  bandwidth at sample rate of  $250SPS$  and the magnitude bode diagram of the recording channel transfer function is depicted in Fig.6 (below plot). Moreover both wired (USB) and wireless (BT) connections were tested. Once the system main functions have been proved, some in-vivo EEG measurements, on one human subject, were performed. To evaluate the signal quality of the designed EEG recorder, the system was compared with a commercial device (Brain QUICK, (Micromed, 2014)) depicted in Fig.9 where the huge difference in terms of dimensions between the two devices is also highlighted. Moreover, the experimental setup, depicted in Fig.10, includes a commercial EEG cap (KIT-CAP-SPEXT61 from Micromed) with 61 electrodes used to acquire the neural signals.

To better compare the two devices, they were

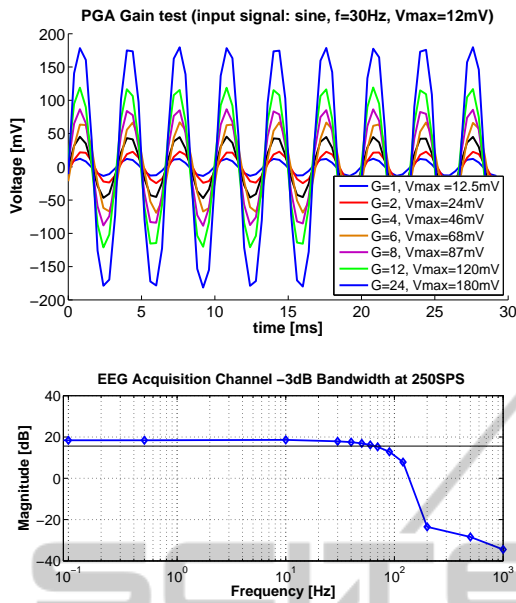

Figure 6: The EEG interface gain programmability validated recording a  $12mV - 30Hz$  sine at  $250SPS$  (on the top) and the system  $-3dB$  bandwidth ( $63.5Hz$ ) at  $250SPS$  (on the bottom).

connected to adjacent electrodes and simultaneous recordings were performed in different patient conditions. During the first test, the human subject was in resting state with closed eyes to avoid any kind of artifact. Fig.7 and Fig.8 show the EEG signals respectively acquired by the Brain Quick and by our EEG recorder. The signals recorded at  $250SPS$  are quite similar in both time and frequency domains. In Fig.11 it is possible to appreciate the differences between an open-eyes (on the left) and a closed-eyes (on the right) EEG signal perfectly recorded by our device at  $250SPS$ . Finally, to further validate our system, some typical EEG artifacts such as the teeth-grinding signal (Fig.12) and the eyes-blinking effect (Fig.13) were recorded. They respect the typical shapes and amplitudes of such signals.

## 5 CONCLUSIONS AND DISCUSSION

An off-the-shelf based EEG interface was presented. It is a wearable system that, thanks to its small dimensions (height:  $5.5cm$  x width:  $3.5cm$  x depth:  $1.0cm$ ), can be easily placed on the patient head and integrated with the electrodes framework. The developed device has 8 independent acquisition channels and was designed with the aim of being user-friendly and suitable for all applications in which a contin-

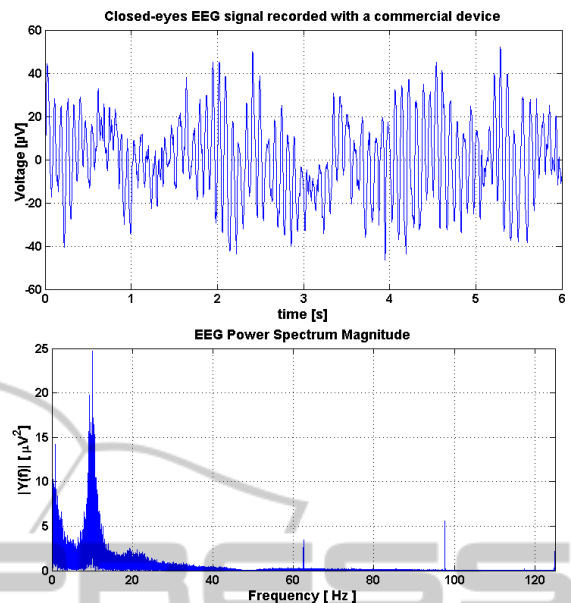

Figure 7: Closed-eyes EEG signal, in time and frequency domain, recorded at  $250SPS$  by Micromed Brain QUICK (Micromed, 2014).

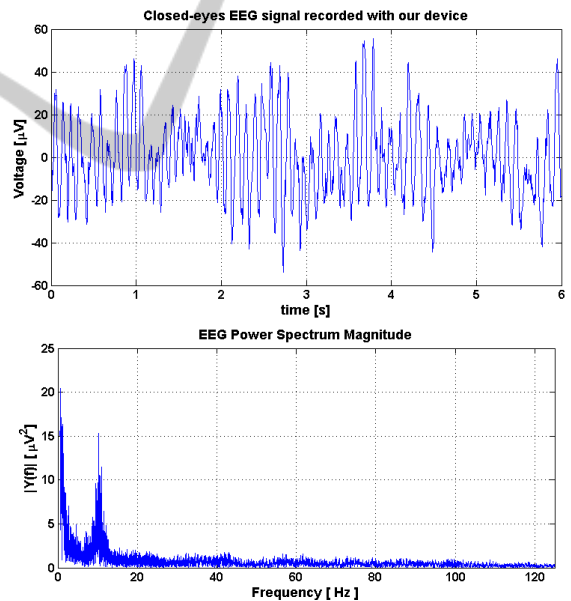

Figure 8: Closed-eyes EEG signal, in time and frequency domain, recorded by our device at  $250SPS$ .

uous EEG monitoring is required. In fully working condition (i.e. when acquiring and transmitting data) the system exhibits an overall power consumption of  $270mW$ . Even-though it is higher than of other systems (Tab.3), the device allows 13 hours of continuous signal recording that is in line with other wearable devices. The higher power consumption is mainly due to the choice of using a COTS solution and a BT link to connect a remote controller. However it gives

Table 3: Comparison between some state-of-the-art EEG Recorders.

	Our device	Quasar	Imec	Emotiv Epoc	NeuroSky	Brown L.	Enobio
CMRR	$> 110dB$	$> 120dB$					$115dB$
Input Impedance	$1G\Omega$	$47G\Omega$					
Bandwidth	$0.01 - 524Hz$	$0.02 - 120Hz$	$0.3 - 100Hz$	$0.2 - 45Hz$	$3 - 100Hz$	$0.5 - 375Hz$	$0 - 250(500)Hz$
Channel number	8	12	12	14	1	8	$8 - 20(32)$
Noise	$< 2\mu Vpp$	$3\mu Vpp$	$4\mu Vpp$			$1\mu Vpp$	$< 1\mu Vrms$
Bit number	24	16	12	16		11	24
Wireless protocol	BT	Proprietary	Nordic RF	Proprietary	BT	Proprietary	BT
Power consumption	$270mW$		$42mW$		$130mW$	$12mW$	
Run time	$13h$	$24h$		$12h$	$10h$	$30h$	$16h$
Technology	COTS		ASIC / COTS			ASIC / COTS	

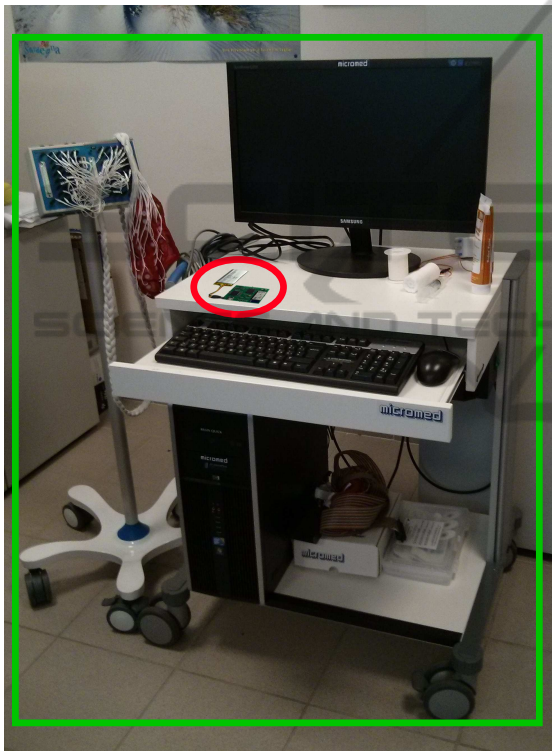

Figure 9: Comparison between our wearable EEG interface (red circle) and a cumbersome commercial device (green box).

the device the great advantage to easily connect any BT-based end-terminal in contrast to other systems that, using a proprietary wireless link, require specific hardware. Moreover, compared to others state-of-the-art equipments, our EEG recorder has a wider bandwidth, up to  $524Hz$ , allowing high-frequency EEG monitoring. This can be very useful to deeper understand and investigate a certain number of pathologies. In addition, a Windows-based Visual C++ software was written for the EEG recorder testing purpose. The system was completed validated by in-vivo measurements on human patient and compered with a commercial laboratory equipment.

Moving towards a device that can easily become part of everyday life for all people improving their



Figure 10: Experimental setup for in-vivo EEG measurements.

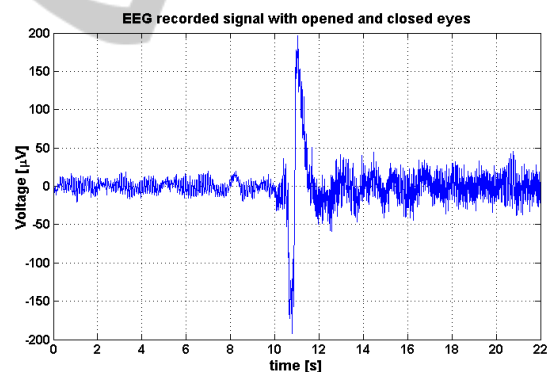

Figure 11: EEG recorded signal with opened-eyes (on the left) and closed-eyes (on the right).

living conditions from both health and entertainment points of view and with the least economical and daily-activity impact is our main goal. Therefore, being a wearable device, next developments are the reduction of the power consumption and the developing of smartphone-based application to respectively increase the battery life and to make the system completely portable. In particular, some future improvements include the use of a new generation BT called Bluetooth 4.0 Low Energy (BTLE) that drastically reduce the power transmission and a review of the control unit strategy turning off, time by time, all on-

board unused devices. Moreover the possibility to optionally expand the number of input channels by plugging in an additional acquisition module and the introducing of on-board data storage capabilities might be considered. Finally, a custom chip solution for signal conditioning and converting will might be investigated to further reduce both power consumption and system dimensions.

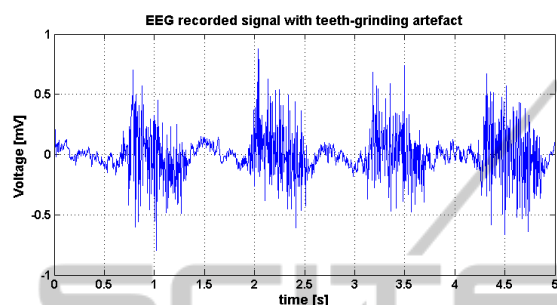

Figure 12: EEG recorded signal with teeth-grinding artefacts.

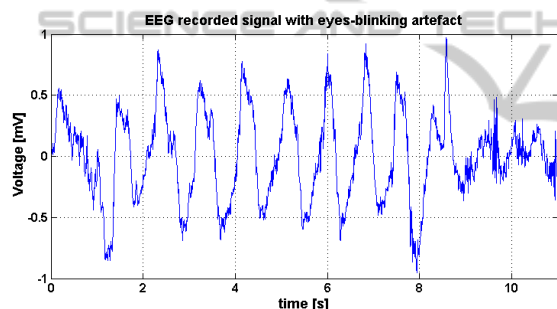

Figure 13: EEG recorded signal with eyes-blinking artefacts.

## ACKNOWLEDGEMENTS

The authors would like to thank Dr. Matteo Frascini and Matteo Demuru from the University of Cagliari for their support on EEG recording in-vivo experiments. L. Bioni gratefully acknowledges Sardinia Regional Government for the financial support of his PhD scholarship (P.O.R. Sardegna F.S.E. Operational Programme of the Autonomous Region of Sardinia, European Social Fund 2007-2013 - Axis IV Human Resources, Objective I.3, Line of Activity I.3.1.).

## REFERENCES

- A. Riera, S. Dunne, I. C. G. R. (2008). Starfast: a wireless wearable eeg/ecg biometric system based on the eno-bio sensor. *Proceedings of the International Workshop on Wearable Micro and Nanosystems for Personalised Health (pHealth08)*.
- Alonso J., Angermeyer MC., B. S. e. a. (2004). Prevalence of mental disorders in europe: results from the european study of the epidemiology of mental disorders (esemed) project. *Acta Psychiatrica Scandinavica*, 109:21–27.
- Brown L., Van de Molengraft J., Y. R. T. T. e. a. (2010). A low-power, wireless, 8-channel eeg monitoring headset. *Engineering in Medicine and Biology Society (EMBC), 32<sup>nd</sup> Annual International Conference of the IEEE EMBS*:4197–4200.
- Carmo J.P., Dias N.S., S.H.M.P. e. a. (2007). A 2.4-ghz low-power/low-voltage wireless plug-and-play module for eeg applications. *Sensors Journal*,7:1524–1531.
- Chan S.R., Torous J., H. L. and P., Y. (2014). Mobile telemental health: Increasing applications and a move to hybrid models of care. *Healthcare*, 2(2):220–233.
- El Khaddar, M., Harroud, H., Boulmalf, M., ElKoutbi, M., and Habbani, A. (2012). Emerging wireless technologies in e-health trends, challenges, and framework design issues. *Multimedia Computing and Systems (ICMCS), 2012 International Conference on*, pages 440–445.
- Emotiv (2013). <http://emotiv.com>.
- J. Olesen, A. Gustavsson, M. S. H.-U. W. e. a. (2012). The economic cost of brain disorders in europe. *European Journal of Neurology*, 19:155–162.
- Lin, C.-T., Ko, L.-W., Chiou, J.-C., Duann, J.-R., Huang, R.-S., Liang, S.-F., Chiu, T.-W., and Jung, T.-P. (2008). Noninvasive neural prostheses using mobile and wireless eeg. *Proceedings of the IEEE*, 96(7):1167–1183.
- Lupu, C. and Cosmin-Constantin, M. (2013). Actual portable devices as base for telemedicine and e-health: Research and case study application. *E-Health and Bioengineering Conference (EHB), 2013*, pages 1–4.
- Micromed (2014). Brain quick. <http://www.micromed.eu>.
- Mihajlovic, V., Grundlehner, B., Vullers, R., and Penders, J. (2014). Wearable, wireless eeg solutions in daily life applications: What are we missing? *Biomedical and Health Informatics, IEEE Journal of*, PP(99):1–1.
- NeuroSky (2009). <http://neurosky.com>.
- Patki, S., Grundlehner, B., Verwegen, A., Mitra, S., Xu, J., Matsumoto, A., Yazicioglu, R., and Penders, J. (2012). Wireless eeg system with real time impedance monitoring and active electrodes. *Biomedical Circuits and Systems Conference (BioCAS), 2012 IEEE*, pages 108–111.
- Quasar (2013). <http://www.quasarusa.com>.
- Sapal Tachakra, X.H. Wang, R. S. I. and Song, Y. (2003). Mobile e-health: The unwired evolution of telemedicine. *Telemedicine Journal and e-Health*, 9(3):247–257.
- Smith, A. (2013). Smartphone ownership 2013. *Pew Research Center*, <http://www.pewinternet.org/2013/06/05/smartphone-ownership-2013/>.
- Waterhouse, E. (2003). New horizons in ambulatory electroencephalography. *Engineering in Medicine and Biology Magazine*, 22:74–80.