

Radial Basis Function Neural Network Receiver for Wireless Channels

Pedro Henrique Gouvêa Coelho and Fabiana Mendes Cesario

State Univ. of Rio de Janeiro, FEN/DETEL, R. S. Francisco Xavier, 524/Sala 5027E, Maracanã, RJ, 20550-900, Brazil

Keywords: Neural Networks, Artificial Intelligence Applications, Channel Equalization, Wireless Systems.

Abstract: Artificial Neural Networks have been widely used in several decision devices systems and typical signal processing applications. This paper proposes an equalizer for wireless channels using radial basis function neural networks. An equalizer is a device used in communication systems for compensating the non-ideal characteristics of the channel. The main motivation for such an application is their capability to form complex decision regions which are of paramount importance for estimating the transmitted symbols efficiently. The proposed equalizer is trained by means of an extended Kalman filter guaranteeing a fast training for the radio basis function neural network. Simulation results are presented comparing the proposed equalizer with traditional ones indicating the efficiency of the scheme.

1 INTRODUCTION

Channel equalization purpose is to remove the effects of the channel on the transmitted symbol sequence, namely the inter-symbol interference (ISI). Typically, this task can be done either by inverse filtering, Decision-Feedback-Equalization (DFE) or by means of sequential detection usually using Viterbi algorithm. Wireless channels can exhibit delay dispersion, in other words, Multi Path Components (MPCs) can have different runtimes from the transmitter (TX) to the receiver (RX). Delay dispersion causes ISI, which can greatly degrade the transmission of digital signals. Even a delay spread that is smaller than the symbol duration can cause a considerable Bit Error Rate (BER) degradation. If the delay spread becomes comparable with or larger than the symbol duration, as occurs often in second and third generation cellular systems, then the BER becomes unacceptably large if no countermeasures are taken. Also when a signal is transmitted through wireless medium then due to multipath effect there is fluctuation in signal amplitude, phase, and time delay. This effect is often known as fading (Proakis, 2001). Coding and diversity can decrease, but not completely eliminate, errors due to ISI. On the other hand, delay dispersion can also be a positive effect. Since fading of the different MPCs is statistically

independent, resolvable MPCs can be interpreted as diversity paths. Delay dispersion thus gives the possibility of delay diversity, if the RX can separate, and exploit, the resolvable MPCs. Equalizers are RX structures that work both ways - they reduce or eliminate ISI, and at the same time exploit the delay diversity inherent in the channel. The operational principle of an equalizer can be visualized either in the time domain or the frequency domain. In this paper the time-domain approach is pursued. For an interpretation in the frequency domain, remember that delay dispersion corresponds to frequency selectivity. In other words, ISI arises from the fact that the transfer function is not constant over the considered system bandwidth. The objective of an equalizer is thus to reverse distortions by the channel. That is, the product of the transfer functions of channel and equalizer should be constant (Proakis, 2001). The channel dynamics may not be known at startup. Moreover the channel may vary with time, so an adaptive implementation of the equalizer is essential. The following different modes of adaptation can be listed:

- Adaptation using a training signal;
 - Decision directed adaptation - An error signal is generated by comparing input and output of the decision device;
 - Blind adaptation: Exploiting signal properties instead of using an error signal for adaptation;
- In this paper a training signal is used for the

equalizer adaptation. Summing up, digital communication systems operates on time varying dispersive channels which often employ a signaling format in which customer data are organized in blocks preceded by a known training sequence. The training sequence at the beginning of each block is used to estimate channel or train an adaptive equalizer. Depending on the rate at which the channel changes with time, there may not be a need to further track the channel variations during the customer data sequence. This paper proposes a channel equalizer for wireless channels using Radial Basis Function (RBF) neural networks as the equalizer structure on a symbol by symbol decision basis. RBFs (Mulgrew, 1996) have been used in the area of neural networks where they are applied as a replacement for the sigmoidal transfer function. Such networks have three layers: the input layer, the hidden layer with the RBF nonlinearity, and a linear output layer, as shown in Fig. 1 (Burse et al, 2010). Due to obvious reasons, the most popular choice for the nonlinearity is the Gaussian function. The RBF equalizer classifies the received signal according to the class of the center closest to the received vector (Assaf et al, 2005). The output of the RBF equalizer supplies an attractive alternative to the Multi-Layer Perceptron (MLP) type of Neural Network for channel equalization problems because the structure of the RBF network has a close relationship to Bayesian schemes for channel equalization and interference exclusion problems. This paper is divided into four sections. Section 2 does a brief discussion of RBF artificial neural networks. Section 3 presents the application of RBF neural networks to the equalization problem and section 4 ends the paper by presenting conclusions.

2 RBF NEURAL NETWORKS

RBF neural networks are the second more used architecture after feedforward neural networks. Denoting the input (vector) as x and the output as $y(x)$ (scalar), the architecture of a RBF neural network is given by

$$y(x) = \sum_{i=1}^M w_i \exp\left(-\frac{(\|x - c_i\|)^2}{2\sigma^2}\right) \quad (1)$$

using Gaussian function as basis functions. Note that, c_i are called centers and σ is called the width. There are M basis functions centered at c_i , and w_i are named weights.

RBF neural networks are very popular for function

approximation, curve fitting, time series prediction, control and classification problems. The radial basis function network differs from other neural networks, showing many distinctive features. Due to their universal approximation, more concise topology and quicker learning speed, RBF networks have attracted considerable attention and they have been widely used in many science and engineering fields (Oyang et al., 2005), (Fu et al., 2005), (Devaraj et al., 2002), (Du et al., 2008), (Han et al., 2004). The determination of the number of neurons in the hidden layer in RBF networks is somewhat important because it affects the network complexity and the generalizing capability of the network. In case the number of the neurons in the hidden layer is insufficient, the RBF network cannot learn the data adequately. On the other hand, if the number of neurons is too high, poor generalization or an overlearning situation may take place (Liu et al., 2004). The position of the centers in the hidden layer also influences the network performance significantly (Simon, 2002), so determination of the optimal locations of centers is an important job. Each neuron has an activation function in the hidden layer. The Gaussian function, which has a spread parameter that controls the behavior of the function, is the most preferred activation function. The training method of RBF networks also includes the optimization of spread parameters of each neuron. Later on, the weights between the hidden layer and the output layer must be selected suitably. Finally, the bias values which are added with each output are determined in the RBF network training procedure. In the literature, several algorithms were proposed for training RBF networks, such as the gradient descent (GD) algorithm (Karayiannis, 1999) and Extended Kalman filtering (EKF) (Simon, 2002). Several global optimization methods have been used for training RBF networks for different science and engineering problems such as genetic algorithms (GA) (Barreto et al., 2002), the particle swarm optimization (PSO) algorithm (Liu et al., 2004), the artificial immune system (AIS) algorithm (De Castro et al., 2001) and the differential evolution (DE) algorithm (Yu et al., 2006). The Artificial Bee Colony (ABC) algorithm is a population based evolutionary optimization algorithm that can be used to various types of problems. The ABC algorithm has been used for training feed forward multi-layer perceptron neural networks by using test problems such as XOR, 3-bit parity and 4-bit encoder/decoder problems (Karaboga et al., 2007). Due to the need of fast convergence, EKF training was chosen for the RBF equalizer reported in this paper, details on the

training process can be found on (Simon, 2002).

3 RBF NEURAL EQUALIZER

Radial Basis Function Neural Networks have been used for channel equalization purposes (Lee et al., 1999), (Gan et al., 1999), (Kumar et al. 2000), (Xie and Leung, 2005). Typically, such networks have three layers: the input layer, the hidden layer with the RBF nonlinearity, and a linear output layer, as shown in Fig. 1 (Burse et al., 2010). The RBF equalizer classifies the received signal according to the class of the center closest to the received vector. The output of the RBF NNs gives an attractive alternative to traditional equalization methods for channel equalization problems because the structure of the RBF network has a close relationship to Bayesian methods for channel equalization and interference rejection problems. Simulations carried out on time-varying channels using a Rayleigh fading channel model to compare the performance of RBF with an adaptive maximum likelihood sequence estimator (MLSE) show that the RBF equalizer produces superior performance with less computational complexity (Mulgrew, 1996). Several techniques have been developed in literature to solve the problem of blind equalization using RBF (Tan et al., 2001), (Uncini et al., 2003) and others. RBF equalizers require less computing demands than other equalizers (Burse et al., 2010).

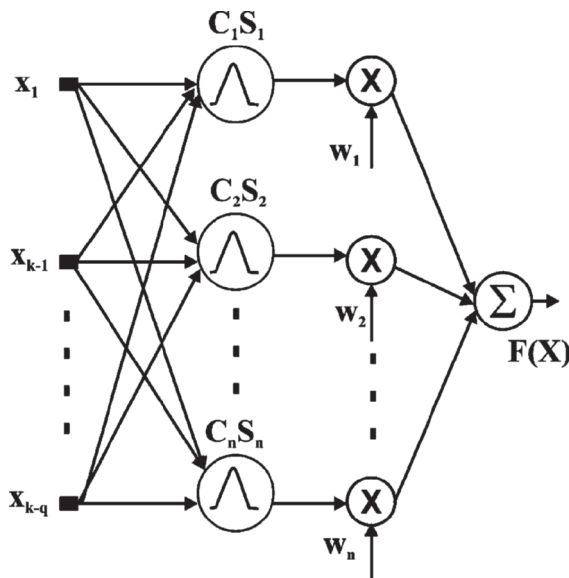

Figure 1: RBF neural network (from Burse et al., 2010).

A comprehensive review on channel equalization

can be found in (Qureshi, 1985). A recent review on Neural Equalizers can be found in (Burse et al., 2010). The equalization scheme can be seen in Fig. 2 (taken from (Molisch, 2011)). The adaptive equalizer in the figure is the RBF Neural equalizer trained by EKF according to (Simon, 2002). The considered channel uses the Rayleigh model (Molisch, 2011) using QPSK modulation.

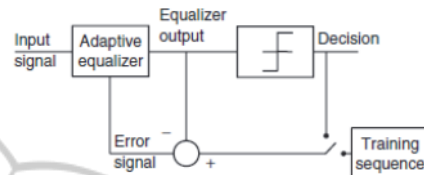

Figure 2: Equalization procedure (from Molisch, 2011).

The QPSK ideal constellation symbols are shown in figure 3. In other words when the communications channel is ideal, there is no distortion or noise so that the symbols are always received with no error. For a real channel the received symbols will show some dispersion as shown in figure 4.

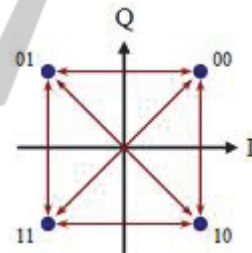

Figure 3: QPSK ideal constellation.

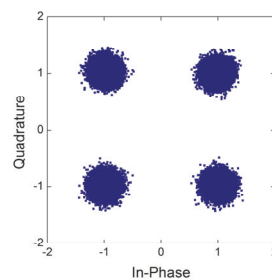

Figure 4: QPSK real scenario constellation.

Several simulations were performed for realistic channel characteristics. Two case studies were carried out. For the first case study, a flat fading channel was considered. Flat fading channels have amplitude varying channel characteristics and are narrowband (Molisch, 2011). A transmission of an

image was included in both case studies. The transmitted image is depicted in figure 5.

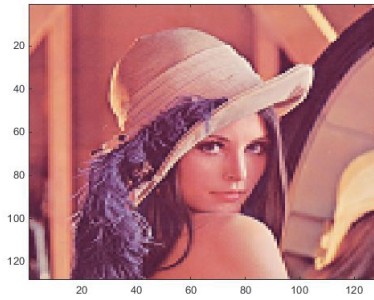

Figure 5: Original transmitted image in case studies.

The simulations also made possible to plot results for comparing the performance in terms of Bit Error Rate (BER) against Signal to Noise Ratio (SNR) and Symbol Error Rate (SER) against SNR. The received image for the RBF – EKF equalizer and the Decision Feedback Equalizer (DFE) which is a quite popular traditional equalizer is shown in figures 6 and 7.

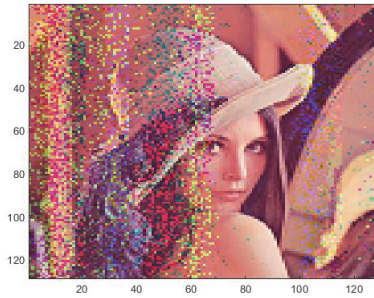

Figure 6: RBF-EKF received image for flat fading.

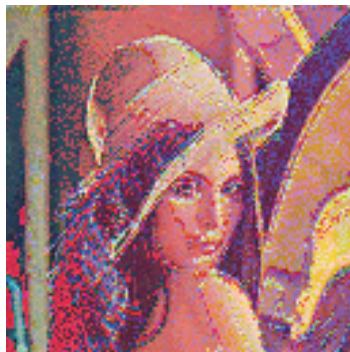

Figure 7: DFB received image for flat fading.

In a qualitative way, one can see that the EKF-EBF equalizes better. For a quantitative description figure 8 shows the BER x SNR and SER x SNR for comparing the two equalizers. The theoretical curve

is also shown for comparative purposes. One can see that the RBF-EKF equalizer performs better as the comparison of the received images indicated. It can be also seen that for low SNRs the performance of the EKF-RBF equalizer is very close the theoretical performance. As SNR values increase the equalizer begins to get away from the theoretical model.

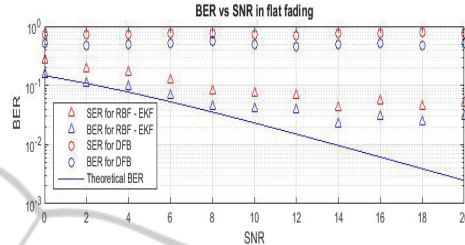

Figure 8: BER x SNR for case study 1.

Figure 9 shows a constellation diagram for the equalizers in case study 1, and it can be seen a cluster formation around the original symbols for both equalizers, indicating that errors might occur in the receiver output.

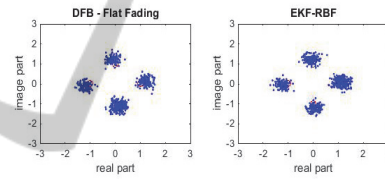

Figure 9: BER x SNR for case study 1.

In case study 2, a frequency selective fading was considered which is a more severe type of fading (Molisch, 2011). Figures 10 and 11 show the received images corresponding to EKF-RFB and DFB equalizers.

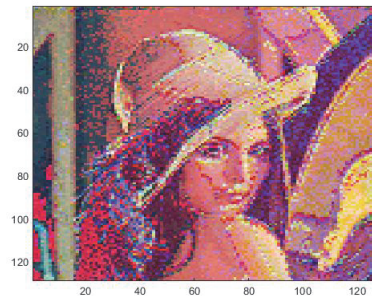

Figure 10: DFB received image for case study 2.

One can see a more intensive degradation in the image for both equalizers, although the DFB is still worse. The performance curves are depicted in

figure 12 which shows clearly the degradation in performance for both equalizers as far as frequency selective fading is concerned.

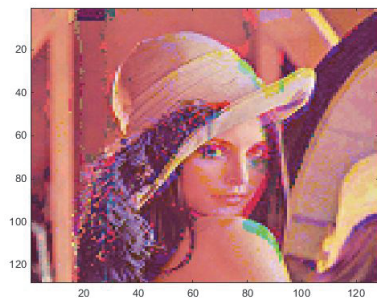

Figure 11: EKF-RBF received image for case study 2.

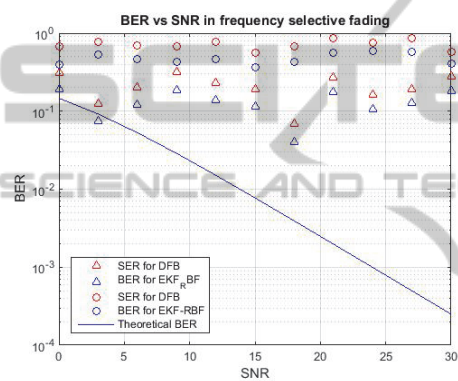

Figure 12: BER x SNR for case study 2.

4 CONCLUSIONS

This paper proposed a radial basis function (RBF) equalizer trained by an extended Kalman filter (EKF). The advantages of using a Kalman filter for training the RBF neural equalizer are that it provides the same performance as gradient descent training, but with only a fraction of the computational effort. Moreover if the decoupled Kalman filter is used, the same performance is guaranteed with further decrease on the computational effort for large problems. The equalizer was simulated and two case studies were reported where its performance was compared with the popular Decision feedback equalizer and the results indicated the proposed equalizer performed better. For future work the authors intend to consider improvements on the RBF equalizer as far as the tracking of time-variations is concerned.

REFERENCES

- Proakis, J. G., 2001. Digital Communications. Fourth Edition, McGraw-Hill.
- Mulgrew, B., 1996. Applying Radial Basis Functions. *IEEE Signal Processing Magazine*, vol. 13, pp. 5065.
- Burse K., Yadav R. N., and Shrivastava S. C., 2010. Channel Equalization Using Neural Networks: A Review. *IEEE Transactions on Systems, Man, and Cybernetics, Part C: Applications and Reviews*, Vol. 40, No. 3.
- Assaf, R., El Assad, S., Harkouss, Y., 2005. Adaptive equalization for digital channels RBF neural network. *In The European Conference on Wireless Technology*, pp. 347-350.
- Lee J., Beach C., and Tepedelenlioglu N., 1999. A practical radial basis function equalizer. *IEEE Trans. Neural Netw.*, vol. 10, no. 2, pp. 450-455.
- Gan Q., Saratchandran P., Sundararajan N., and Subramaniam K. R., 1999. A complex valued RBF network for equalization of fast time varying channels. *IEEE Trans. Neural Netw.*, vol. 10, no. 4, pp. 958-960.
- Kumar C. P., Saratchandran P., and Sundararajan N., 2000. Nonlinear channel equalization using minimal radial basis function neural networks. *Proc. Inst. Electr. Eng. Vis., Image, Signal Process.*, vol. 147, no. 5, pp. 428-435.
- Xie N. and Leung H., 2005. Blind equalization using a predictive radial basis function neural network. *IEEE Trans. Neural Netw.*, vol. 16, no. 3, pp. 709-720.
- Tan Y., Wang J., and Zurada J. M., 2001. Nonlinear blind source separation using a radial basis function network. *IEEE Trans. Neural Netw.*, vol. 12, no. 1, pp. 124-134.
- Uncini A. and Piazza F., 2003. Blind signal processing by complex domain adaptive spline neural networks. *IEEE Trans. Neural Netw.*, vol. 14, no. 2, pp. 399-412.
- Oyang, Y.J., Hwang, S.C., Ou, Y.Y., Chen, C.Y., Chen, Z.W., 2005. Data classification with radial basis function networks based on a novel kernel density estimation algorithm. *IEEE Trans. Neural Netw.*, 16, 225-236.
- Fu, X., Wang, L., 2003. Data dimensionality reduction with application to simplifying rbf network structure and improving classification performance. *IEEE Trans. Syst. Man Cybern. Part B*, 33, 399-409.
- Devaraj, D., Yegnanarayana, B., Ramar, K., 2002. Radial basis function networks for fast contingency ranking. *Electric. Power Energy Syst.*, 24, 387-395.
- Du, J.X., Zhai, C.M., 2008. A hybrid learning algorithm combined with generalized rls approach for radial basis function neural networks. *Appl. Math. Comput.*, 208, 908-915.
- Han, M., Xi, J., 2004. Efficient clustering of radial basis perceptron neural network for pattern recognition. *Pattern Recognit.*, 37, 2059-2067.
- Liu, Y., Zheng, Q.; Shi, Z., Chen, J., 2004. Training radial basis function networks with particle swarms. *Lect. Note. Comput. Sci.*, 3173, 317-322.

- Simon, D., 2002. Training radial basis neural networks with the extended Kalman filter. *Neurocomputing*, 48, 455–475.
- Karayiannis, N.B., 1999. Reformulated radial basis neural networks trained by gradient descent. *IEEE Trans. Neural Netw.*, 3, 2230–2235.
- Barreto, A.M.S., Barbosa, H.J.C., Ebecken, N.F.F., 2002. Growing Compact RBF Networks Using a Genetic Algorithm. In *Proceedings of the 7th Brazilian Symposium on Neural Networks*, Recife, Brazil, pp. 61–66.
- De Castro, L.N., Von Zuben, F.J., 2001. An Immunological Approach to Initialize Centers of Radial Basis Function Neural Networks. In *Proceedings of Brazilian Conference on Neural Networks*, Rio de Janeiro, Brazil, pp. 79–84.
- Yu, B., He, X., 2006. Training Radial Basis Function Networks with Differential Evolution. In *Proceedings of IEEE International Conference on Granular Computing*, Atlanta, GA, USA, 369–372.
- Karaboga, D., Akay, B., 2007. Artificial Bee Colony (ABC) Algorithm on Training Artificial Neural Networks. In *Proceedings of 15th IEEE Signal Processing and Communications Applications*, Eskisehir, Turkey.
- Qureshi, S., 1985. Adaptive equalization. *Proceedings of The IEEE - PIEEE*, vol. 73, no. 9, pp. 1349–1387.
- Molisch, A. S., 2011. *Wireless Communications. Second Edition*. John Wiley & Sons.