

Angular Arrangement Optimization of the Support Racks of Gas Turbine Engine to Reduce the Circumferential Unevenness of Gas Flow

Grigorii M. Popov, Daria Kolmakova and Aleksandr O. Shklovets

Institute of Propulsion and Power Systems, Samara State Aerospace University (SSAU), Samara, Russian Federation

Keywords: Circumferential Distortion, Axial Compressor, Rotor Blades, Support Racks.

Abstract: This work is motivated by the necessity to reduce the effects of the flow circumferential distortion in the flow passage of the aircraft gas turbine engine (GTE). During the presented research, another principal of reduction of the flow circumferential distortion was chosen. Firstly, the variants of upgrading the existing support racks were found. Secondly, the new design of support was offered. Both version of the support design variation took into account the availability of technological and structural limitations associated with the location of oil pipes, springs and others elements in the support racks. Investigations of modified design showed that the support with altered racks provides a reduction of dynamic stresses by 20% at resonance with the most dangerous harmonic, and the new design of support can give the decrease of 30%.

1 INTRODUCTION

Many problems that are currently faced by researchers and engineers cannot be solved analytically or require huge costs for the experimental realization. Often, the only possibility to carry out the express analysis of engineering problems is a computer and mathematical simulation. Progress in the development of numerical methods significantly increased the number of tasks available for analysis (Popov, et al., 2014.). The obtained results based on these methods are used in almost all fields of science and technology.

The finite element method finds its most important application in the design analysis. At the same time, bridges, buildings, marine hulls, aircraft components, machine parts, pistons, tools, i.e. any engineering construction are understood under “construction” in the design analysis.

Turbomachinery impellers are very critical parts of gas turbine engines. The reliable engine operation and flight safety of the aircraft depend on their reliable operation of impellers to a large extent (Shabliy and Cherniaev, 2014).

The possibility of appearance of variable dynamic stresses in the impellers associated with the

action of the changing in time loads on it. One of the main types of dangerous oscillations are forced.

Forced oscillations are due to the impact of external forces on the object, time-varying, which do not depend on dynamic behaviour of a vibrating object and do not change under the assumption of object non-deformable. In turbomachines these forces associated with circumferential uniform of flow incident on the rotating impeller. The circumferential distortion is transformed into power load that varies in time.

2 CALCULATION METHOD OF FORCED OSCILLATIONS

Circumferential nonuniformity of the gas stream flowing around the blades is the main source of vibration excitation of the gas turbine engine rotor wheels (RW). It appears in the form of nonuniformity of the velocity and pressure fields in the stream before and after the RW. Nonuniformity leads to the fact that the gas load intensity in the circumferential and radial directions is inconstant around the circumference of the flow passage. The integrated gas-dynamic force Q_g changeable in value acts on any of the blades during RW rotation.

Since the gas-dynamic force Q_g is a periodic value, i.e. $Q_g(\alpha) = Q_g(\alpha + 2\pi)$, it can be expanded in a Fourier series:

$$Q_g = \sum_{m_e}^{\infty} Q_m \cdot \cos(m_e \alpha - \gamma_m) = \quad (1)$$

where Q_m – the amplitude of the component harmonic; m_e – harmonic number; α – center angle, γ_m – phase shift along the circumference.

Expansion (1) allows presenting the gas load having a complex distribution along the circumference as a sum of component harmonics. Each of them represents a succession of load waves that fit around the circumference of flow passage.

For rotating impeller, any of the components in (1) is exciting harmonic, which is the backward running waves succession. The load rotates with an angular velocity ω , which equal to the angular velocity of RW. Thus, the circumferential gas flow nonuniformity for rotor wheels is equivalent to an effects of infinite set of exciting harmonics, each of which represents a succession m_e of backward running waves of load oscillates in time with frequency $f_e = m_e n_s$, where $n_s = \frac{\omega}{2\pi}$

To determine the dynamic stresses in the blade airfoil, Ansys software was used. Gas dynamic load force on the blades is determined in static CFD-calculation. Using APDL programming language, the program was written that imports the load

distribution from finite element model of blade row in CFX to finite element model of the blade row in Ansys Mechanical APDL. Then, the load is decomposed in Fourier series at congruent nodes of blades and is represented as a backward running wave. Campbell diagram is used to determine the most dangerous engine modes, and correspondingly, the most dangerous harmonics. Dynamic stress analysis is carried out only with the most dangerous harmonic. This method is described in detail in (Ermakov et al., 2014).

Damping in the system is defined on the basis of experimental data as a viscous in material. Thus we cannot state that this calculation method allows evaluating the quantitative dynamic stresses in the blade at the design stage. However, this method is acceptable for qualitative assessment of changes of dynamic stresses during the optimization.

3 IMPLEMENTATION OF METHOD

Practical implementation of the method is discussed in (Ermakov, Shklovets, Popov, Kolmakova, 2014). The object of the investigation is fifth stage rotor wheel blade of medium pressure compressor (IPC) of GTE (Figure 1). Downstream the fifth stage of the IPC, the middle GTE support is located.

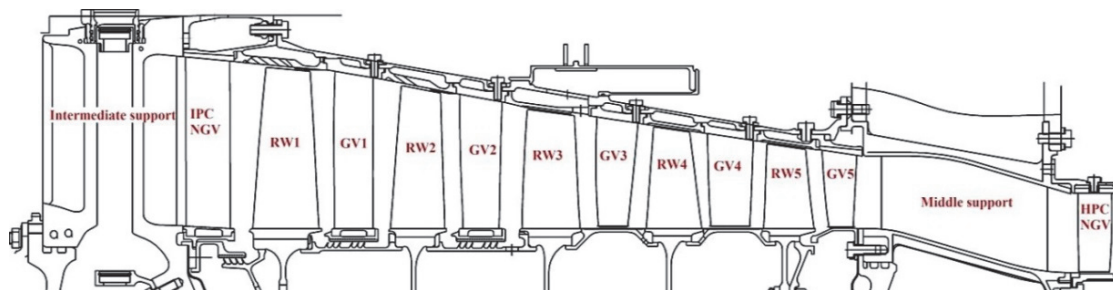

Figure 1: The diagram of the investigated compressor.

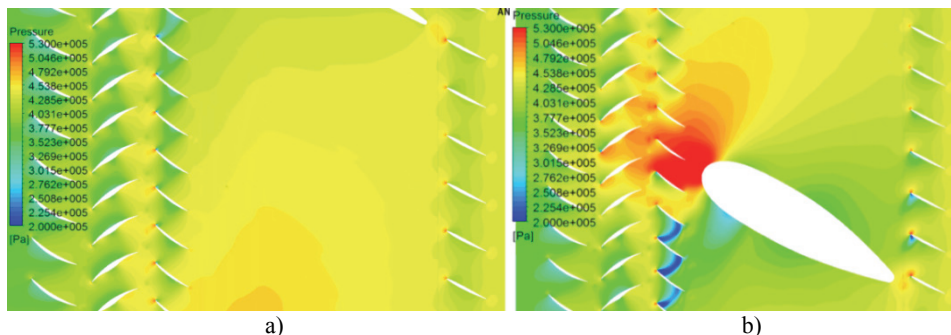

Figure 2: Pressure fields between support rack (a) and close to racks (b).

Seven racks of different cross-sections are unevenly distributed in the flow passage of support casing. These racks cause the circumferential variation of the gas flow in gas-turbine engine flow passage, which leads to increased dynamic stresses in the fifth rotor wheel blades, as a consequence, to its breakage (Figure 2).

As the number of support racks is 7, the blade was detuned from the dangerous seventh harmonic at the design stage. The natural frequency of the RW blade vibrations is selected so that the resonance is possible with the eighth harmonic and higher. Seventh harmonic is beyond the engine operating conditions. Experimental research revealed the destruction of the rotor blade of compressor stage at resonance with the 12th harmonic.

On the basis of the above-described method of calculation of blade forced oscillations, the maximum alternating stresses were defined in the fifth stage rotor blade of IPC reference design operating in the conditions of gas flow circumferential distortion.

To reduce the circumferential distortion of the flow, stagger angles and pitch of fifth stage guide vanes were changed to non-uniform around the circumference of the rotor wheel (Figure 3). At the same time, CFD-calculation qualitatively coincides with the experiment.

As a result, the optimal variant of the design was chosen, in which the amplitude of the dangerous 12th harmonic was reduced by 2 times, while the number of changeable guide vane (GV) blades was equal to 14 (total blade number is 76).

4 EFFECT OF SUPPORT DESIGN ON CIRCUMFERENTIAL DISTORTION

4.1 Changing Angular Location of Support Racks

Technologically, changing the stagger angle of the guide vane blade is challenging, so it was decided to change the configuration of the support rack. Therefore, the experimental variant of support with 13 racks instead of standard support with seven racks was considered at the next stage of the research (Figure 4). The experimental tests were conducted by JSC "Kuznetsov" (Samara, Russia) – the enterprise of aviation and space propulsion engineering. (JSC "Kuznetsov", 2014).

It was revealed that the mean amplitude of

dangerous 12th harmonic decreased by 2 times in the computational studies (experimental data confirm this). The coincidence of obtained results with experimental data confirms the adequacy of computational models and techniques. There was a significant decrease in the amplitudes of all dangerous harmonics.

The rack thickness, in which the engine systems are located, and their angular disposition were changed in the 13-racks experimental support. Therefore, such support cannot be applied at modernized engine. Consequently, one of the conditions was to keep unchanged the racks 1, 3, 4, and 7 of standard 7-racks the support (Figure 4) when optimizing the angular arrangement of racks.

For this, the optimization technique of the angular position of support racks was developed. Angular position of racks was represented as a periodic function. Function was provided in the form of discrete data array containing the nominal pressure before each rack, which was equal to one. The array contained 180 values; each value corresponded to the angle of the circumferential location of the rack. Then the function value was 0 if there was no the rack and the value was 1 if there was rack is. Changing the angular arrangement of free racks, decrease of dangerous harmonics amplitude can be achieved.

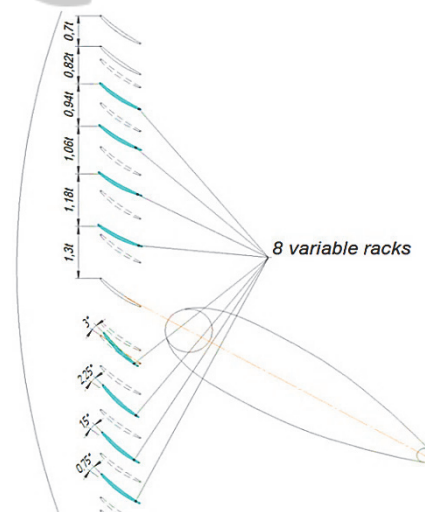

Figure 3: The algorithm of introduction of different stagger angle and pitch.

Reduction in the amplitude of the 12th harmonic was performed using optimization methods implemented in the software package IOSO (Egorov, Kretinin, Leshchenko, Kuptzov, 2002.). The goal of optimization was to decrease the amplitudes of 10th and 12th harmonics.

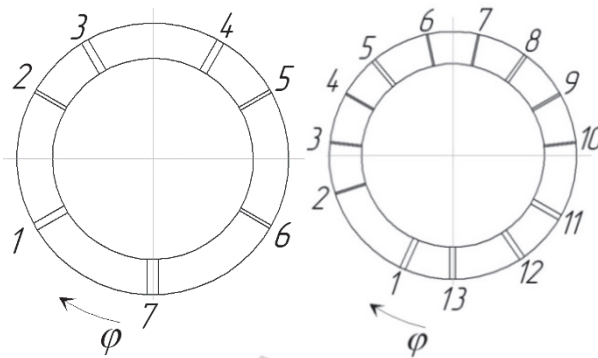

Figure 4: Scheme of standard 7-racks support and modified 13th-racks support.

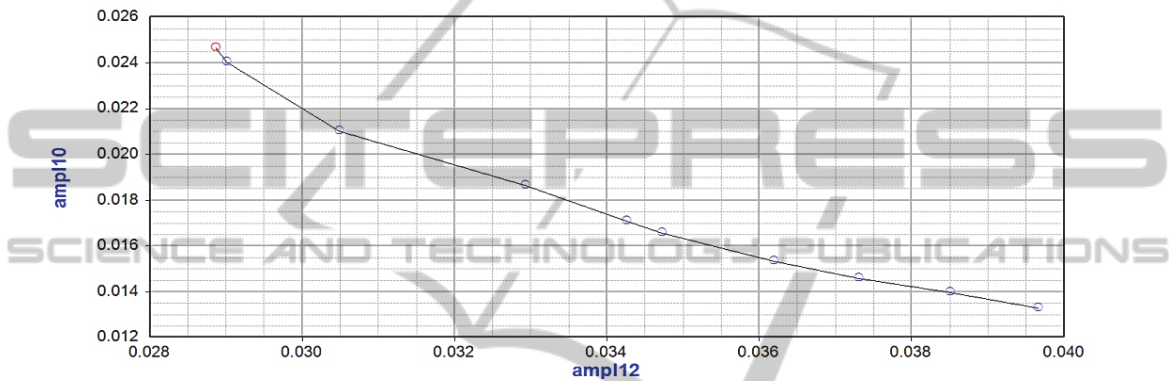

Figure 5: The Pareto set of multicriteria optimization.

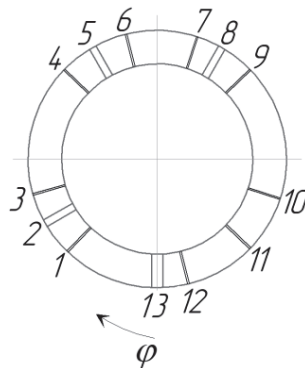

Figure 6: Location of support racks corresponding to the point of the Pareto set.

Consequently, the optimization criterion was the amplitudes of 10th and 12th harmonics.

Angles of the 1, 3, 4, 6, 7, 9-12 racks were used as variable parameters. In formulation of optimization problem, the restrictions on the amplitude values of 8, 9, 11 and 13 harmonics were imposed. These restrictions were assigned so that the amplitude values of these harmonics obviously did not lead to the destruction of the blades.

During the optimization, the Pareto front was obtained - the set of unimprovable solutions, a

compromise between the decrease in the amplitude of 10th and 12th harmonics (Figure 5). A unique array of angular location of 1, 3, 4, 6, 7, 9-12 racks corresponded to each point of the Pareto set.

For further analysis, the leftmost point of Pareto front was selected (Figure 5). This point corresponds to the maximum possible reduction in the amplitude of the 12th harmonic, as the most dangerous. Location of the racks, shown in Figure 6, corresponds to this point of the Pareto set.

4.2 Changing Position of Support Racks Relative to Blades of Upstream Guide Vane

There are experimental studies that prove that the lattice, which is located in front of the cylinder, streamlined by the flow, enhances the upstream transmission of the high pressure zone (Saren, 1984).

The results of that research allow us to offer an additional way to reduce the dynamic stresses. It represents a change in the form of support racks due to remoteness of the leading edge of support racks (cylinder) from the trailing edges of GV blades of fifth stage (lattice). At the same time, the internal cavities of racks remain unchanged for the

placement of engine systems (Figure 7) (Pechenin, Bolotov, Rusanov, 2014).

Figure 8 shows a comparison of the harmonic amplitudes of the optimized 13-racks support without shifting the leading edges and with shifted leading edges of racks. Figure 9 shows a comparison of harmonic amplitudes of the 7-racks support, the reference design of 13-racks support (by JSC “Kuznetsov”) and optimized 13-racks support with shifted leading edges (by SSAU).

Thus, the implementation of optimized 13-racks support with shifted leading edges reduces the amplitude of the most dangerous harmonic in 1.8 times, while the position of four the support racks with engine systems remains unchanged.

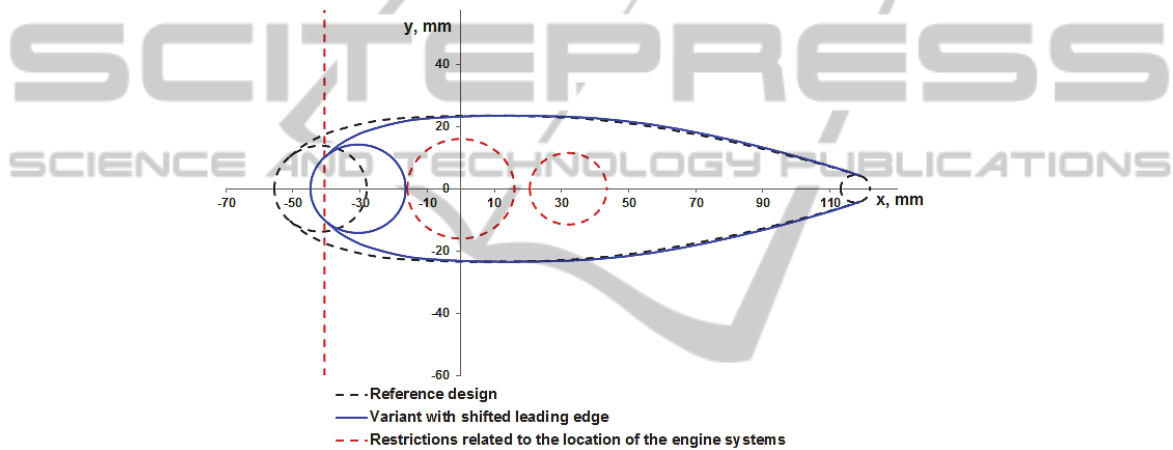

Figure 7: The algorithm of shift of the rack leading edge.

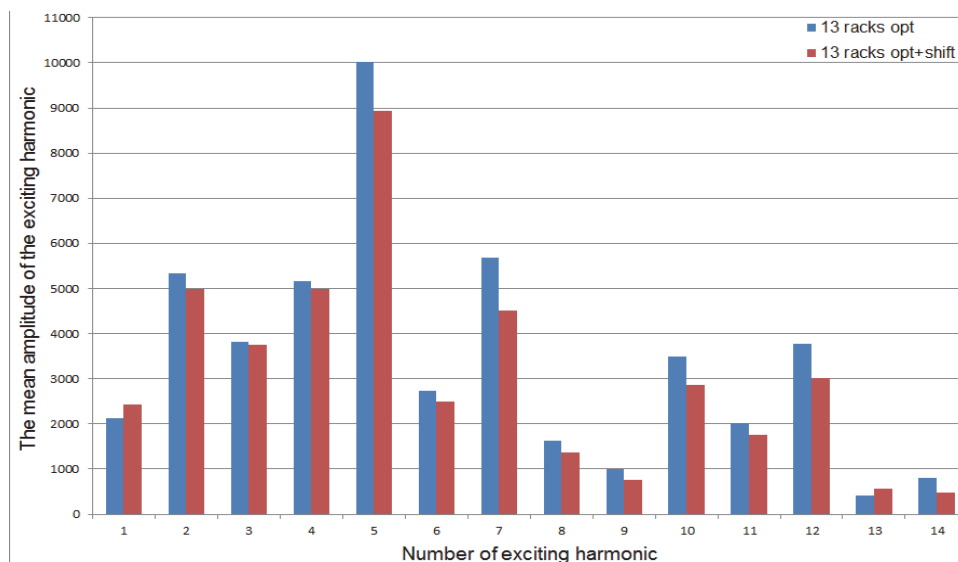

Figure 8: Mean amplitude of the exciting harmonics of the 13-racks support with and without shifted leading edges.

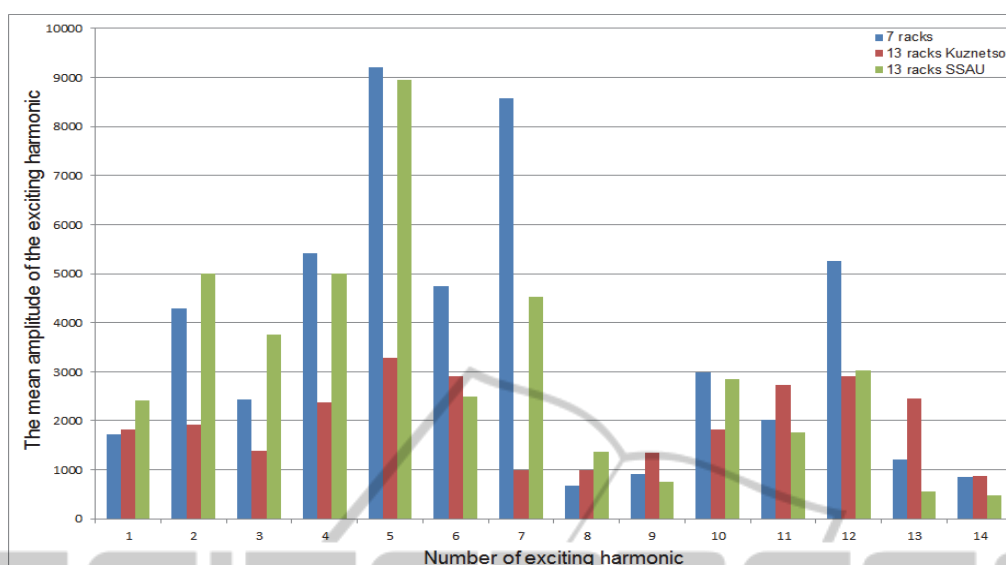

Figure 9: Mean amplitude of the exciting harmonics of the 7-racks support, reference 13-racks support (Kuznetsov) and optimized 13-racks support with shifted leading edges (SSAU).

5 CONCLUSIONS

The high level of circumferential distortion of the gas flow in aircraft engine is caused by many factors. One of the major is the presence of support racks in the flow passage.

Change in the angular position of support racks allows redistributing and reducing the amplitude of the exciting harmonics.

During the research, the optimization technology of angular arrangement of support racks was developed by the software IOSO due to the discrete representation of a response from the rack.

This allowed obtaining the optimum racks location of 13-racks support, providing decrease in the amplitude of 12th harmonic in 2 times.

Furthermore, the variant of variable dynamic stresses reduction was proposed due to shape correction of support racks (shift of the rack leading edges relative to the trailing edges of GV blades located in front of the support).

This method provided a decrease in the amplitude of the 12th harmonic in 1.8 times.

ACKNOWLEDGEMENTS

This work was supported by the Ministry of Education and Science of the Russian Federation in execution of the order №218 from 09.04.2010 (theme code 2013-218-04-4777).

REFERENCES

- Popov, G., Baturin, O., Kolmakova, D. Krivcov, A., 2014. Improvement Results of TK-32 turbocompressor turbine with gas-dynamics and strength CAE-systems. In *International J. of Engineering and Technology* Vol. 6, pp. 2297-03.
- Shabliy, L.S., Cherniaev, A.V., 2014. Optimization of compressor blade geometry for efficiency and pressure ratio under strength constraint. In *Proc. of ASME 2014 Gas Turbine India Conference, GTINDIA 2014*, GTINDIA2014-8132.
- Ermakov, A., Shklovets, A., Popov, G., Kolmakova, D., 2014. Investigation of the effect of the gas turbine compressor supports on gas flow circumferential nonuniformity. In *Research J.1 of Applied Sciences*, vol. 9, pp. 684-690.
- JSC "Kuznetsov", Accessed October 10, 2014. <http://www.kuznetsov-motors.ru/en>.
- Egorov, I., Kretinin, G., Leshchenko, I., Kuptzov, S., 2002. IOSO Optimisation Toolkit - Novel Software to Create Better Design. In *Proc. 9th AIAA/ISSMO Symposium on Multidisciplinary Analysis and Optimisation*.
- Saren, V., 1984. *Flow around irregular lattice of plates placed in front of the cylinder*, Technical Report, Central Institute of Aviation Motors, Moscow.
- Pechenin, V.A., Bolotov, M.A., Rusanov, N.V., 2014. Method of evaluation of profile form and shaped surfaces with application of wavelets. In *Research Journal of Applied Sciences*, Vol. 9 (11), pp. 820-824.