

Control Architecture Modeling using Functional Energetic Method *Demonstration on a Hybrid Electric Vehicle*

Mert Mökücü^{1,2}, Philippe Fiani¹, Sylvain Chavanne¹, Lahsen Ait Taleb¹,
Cristina Vlad² and Emmanuel Godoy²

¹*Sherpa Engineering, R&D Department, 92250, La Garenne Colombes, France*

²*Laboratoire des Signaux et Systèmes (L2S, UMR CNRS 8506), Centrale Supélec - CNRS - Univ. Paris-Sud,
Université Paris Saclay, 3 rue Joliot Curie, F-91192, Gif-sur-Yvette cedex, France*

Keywords: Control Design, Energy Management, Complex Systems, Modeling, Integrated Design, Systems Modeling, Interconnected Systems, System-level Design, System Verification, Automotive Engineering, System Architecture.

Abstract: With the advances on component technology, communication and information, energy systems are becoming more complex. In this context, energy optimization based on various criteria requires the development of relevant and representative models that are able to characterize the system behaviour. Within this study, functional modeling is used to represent a system at a higher level of abstraction, with simple equations, local control loops and a decision manager (DM) for handling the energy flow. The reduced complexity and fast simulation of this model simplify the validation of system architecture and components sizing, as well as the performances evaluation of energy management algorithms according to different criteria. Once this first validation is completed, the following step in the system design process is to test the same algorithms on a more accurate model, represented at multi-physical level, that has its own local controllers and global resource manager (GRM). One way to complete this second validation is to use the information computed using the functional model, to design a high level controller of a more complex multi-physical model. To this purpose, a solution is proposed to interconnect the two models, of the same system, that are represented at different level of abstraction. First, it is shown how the GRM can be extracted from the functional model. Secondly, it is presented how this management system can be adapted in order to be used at multi-physical level. Both models are developed for a plug-in parallel hybrid vehicle (PHEV), and the interconnection solution is illustrated for the considered application.

1 INTRODUCTION

It is important to cite economic and ecological framework that drags industry and researchers towards an innovative energy management involving an association of energy technologies, optimal control laws and refined components. Along with the advancements on component technology, communication between them and obtaining information make systems more intelligent. This growth of intelligence also makes the system more complex. For energy systems, this complexity hardens the work on energy management and control strategies which enforces the research on system engineering. The most important difficulties on this subject are:

- Choosing the system architecture;
- Setting and sizing the system components;
- Optimizing the flow between multi-sources and

multi-consumers;

- Designing a control system architecture.

The goal of system engineering, as far as energy systems are concerned, is to obtain optimal control laws and energy optimisation. Increased complexity and technology advancements on components drive the research to evolve on modeling and simulation. This research is made to design, identify and control the system. All these challenges lead the system developers to research further on:

- A global and interactive approach to improve systematic innovation;
- A methodology for architecture evaluation and system verification from the early stages of the system life cycle;
- A system representation from multiple points of view, in order to define and analyse the main ob-

jectives;

- Design and identification of a control system.

For these reasons, including the tendency to decrease *time – to – market*, the complex system has to be represented at a higher level of abstraction that will ease its global understanding within a structured environment. In the literature, this type of representation is associated with systemic theory (Le Moigne, 1977). Usually, physical models of complex systems have been represented and analysed using Bond Graph modeling and multi-domain simulation (Brunet et al., 2005). However, another interesting approach is the functional modeling (Penalva, 1994), (Suh, 1998), (Mokukcu et al., 2016), which is based on the following principle: a system can be defined by basic elements, modelled with an adequate level of complexity, that faithfully describe the system behaviour.

By construction, Model Based System Engineering (MBSE) allows to specify and design systems at different levels and to specify their elements and the links between them. These links are: components and information, requirements, architecture (functional, multi-physical or otherwise), use cases and validation tests (Fiani et al., 2016).

In (Fiani et al., 2016) and (Mokukcu et al., 2016), three levels of modeling are introduced as:

- Teleological modeling: a system of missions finalized with respect to system environment, governed by regulations and standards;
- Functional modeling: the system of missions can be defined by a set of key functions and the associated architecture that realizes the missions;
- Multi-physical modeling: the key functions are realized by a set of components and an equipment usually provided by suppliers.

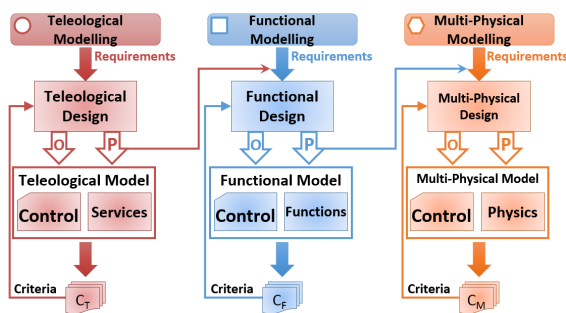

Figure 1: Multi level integrated design and simulation (Fiani et al., 2016).

Fig. 1 illustrates the modeling steps for each system representation at a different level of abstraction. The development starts with requirements formulation. Once the requirements are fixed, the param-

eters (P) and objectives (O) are defined in order to obtain a simulation model and its associated controller. The evaluation of the resulting control system is performed in simulation using validation criteria. If the criteria are satisfied then the parameters of higher levels of modeling will define the requirements of lower levels of modeling. Otherwise, necessary modifications are made in the design process. This mechanism helps to transmit objectives or parameters between different representations of the system. It can be also found out that higher modeling levels become cascade controllers for lower modeling levels (Fiani et al., 2016).

At functional level of abstraction, the system behaviour is represented from an energetic point of view, using simple equations that allow reducing the amount of time needed to complete a simulation. The functional modeling methodology and its semantics (Mokukcu et al., 2016), (Fauvel et al., 2014), (Fauvel, 2015) are based on a FU (Functional Unit), also referred as OFS (Organico-Functional Set) approach. In Fig.2, the representation of a functional model is given. Each element Σ represents a functional unit while D elements are used for energy distribution.

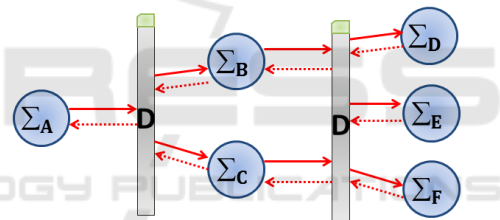

Figure 2: Functional modeling representation.

However, at multi-physical level, the system can be represented as a composition of controlled subsystems (Mokukcu et al., 2016). The block diagram of a multi-physical representation is shown in Fig. 3, where C, I, T and E denote the *local controller*, *input conditioning*, *transformer* and *effector*, respectively. The GRM block acts like an energy management system for the multi-physical model.

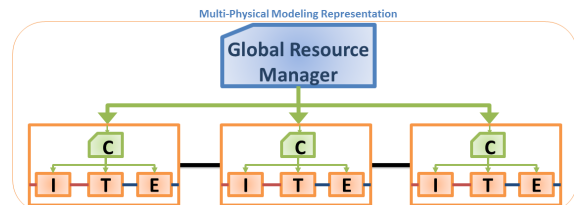

Figure 3: Multi-physical modeling representation.

Indeed, in the early stages of the design process, a functional model is preferred to represent the complex system in order to validate (by fast simulations) the system architecture and components sizing, and

also to evaluate the performances of local controllers and energy management strategies for different missions using different criteria. Naturally, the following stages in the system design process is to test the supervision and control algorithms that have been developed using the functional model, on the multi-physical model. In Fig. 4, the control architecture is illustrated at functional and multi-physical levels of abstraction. On the left side of the figure, the system is represented at functional level and the energy flow within the system is managed by the supervision block DM using optimisation algorithms. On the right side, C is a composition of local controllers of the system, and P includes the physical subsystems. Therefore, the main difficulty is to obtain the global resource manager (GRM) of the multi-physical model using information provided by local controllers and decision manager (DM) of the functional model.

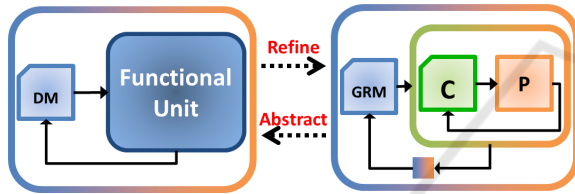

Figure 4: Control system representation.

The struggle of this extraction is given by: which input/output of which physical subsystem should be measured/estimated, how to use these signals to provide energy transfer information to functional model, and after processing this information, how to transform the computed power flow reference into a physical reference signal and transfer it to all different types of controllers of physical subsystems.

For a better understanding of these challenges in the context of an energy system, a hybrid electric vehicle (HEV) is considered as an example of a multi-source/multi-consumer system.

In this work, the issue of interconnecting the functional and multi-physical models is presented, and a solution is proposed showing how the GRM can be extracted from the functional representation and be connected to local controllers of the multi-physical model. In Section 2, the multi-physical and functional modeling methods are briefly introduced. In Section 3, the interconnection procedure between the two modeling levels is discussed. Section 4 presents both models for a plug-in parallel hybrid vehicle, along with the multi-physical model obtained as a result of interconnection. Its performances are tested in simulation for a specific mission. Conclusions and future works are summarized in Section 5.

2 MODELING METHOD REMINDERS

This section introduces briefly the multi-physical and functional modeling methods, which are further applied to model the behaviour of a gear motor group at multi-physical and functional level, respectively.

2.1 Multi-physical Modeling

Multi-physical modeling aims to represent the architecture of technological equipment. Generally in industry the 0D-1D multi-physical modeling is used for a complex system to optimise its sizing, for control laws design and validation. This multi-physical model allows representing the complex system as a whole and is used for simulations, analysis and prediction of system performances.

The multi-physical model is composed by analytical models that provide an accurate description of the multi-physical behaviour of the complex system. The multi-physical model can be developed under the simulation environment Matlab/Simulink using a component-based approach derived from the Bond Graph methodology. It is a language that allows the passage between physical and mathematical models using a block-diagram environment (Brunet et al., 2005). On the other hand, the simulation tool is based on a multi-port concept: a unique link is used to represent and simulate all the interactions between different components. In the multi-physical methodology, this link is represented by energy transfer. Moreover, every link between physical model components consists of a flux variable and an effort variable that depend on the physical domain. In Fig. 5, some examples are given for different domains. Despite the advantages of multi-physical modeling (accuracy and intermediate signals availability), the model design, its simulation and validation are time consuming and require expertise.

—	Mechanical rotation	Torque (N.m)	Speed rot (rad/s)
—	Mechanical translation	Effort (N)	Speed (m/s)
—	Hydraulic	Pressure (Pa)	Flow (kg/s)
—	Thermal	Temperature (K)	Th Flux (J/s)
—	Thermo-fluid	Pressure (Pa)	Flow (kg/s)
—		Temperature (K)	Flow enthalpy (J/s)
—	Electric	Voltage (V)	Current (A)

Figure 5: Multi-physical domains.

For these reasons, it is necessary to use a model of a higher level of abstraction, which does not need the definition of multi-physical elements, in order to easily evaluate the system in the early stages of the design process.

An example of multi-physical model for a gear motor group is given in Fig. 6(b). The transformation of electrical flow into mechanical flow is done using a converter (1), an electrical motor (2), (3) and a gear reducer (4), along with their local controller. For this example, the physical behaviour of each component is represented by a simple analytical model as follows:

$$u_R = u_E \cdot \frac{t_{on}}{t_{on} + t_{off}}. \quad (1)$$

$$u_R = R_R \cdot i_R + L_R \cdot \frac{di_R}{dt} + E. \quad (2)$$

$$J_{CR} \cdot \frac{d^2\theta_m}{dt^2} = \tau_{em} - \tau_p - \tau_{ext}. \quad (3)$$

$$\tau_{ext} = \alpha \cdot \tau_{out}. \quad (4)$$

where u_R denotes the rotor voltage; u_E is the converter supply voltage; t_{on}/t_{off} is the converter on/off time; R_R , i_r , L_R is the resistance, current and inductance of the rotor, respectively; E is the electromotive force; J_{CR} is the inertia; θ_m is the motor angular position; τ_{em} is the electromagnetic torque, τ_p is the loss torque; τ_{ext} is the motor output torque; α is the gear constant and τ_{out} is the gear output torque.

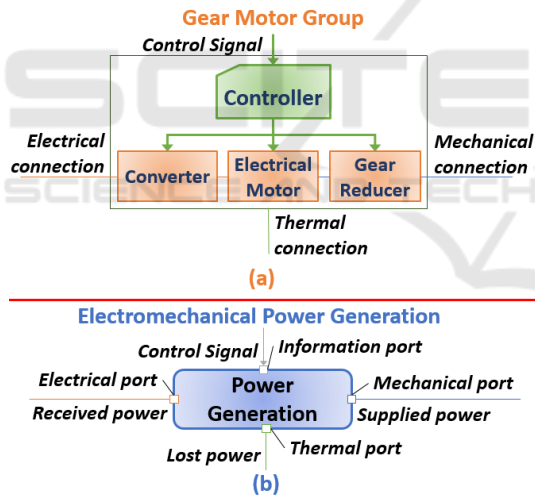

Figure 6: Multi-physical (a) & functional (b) model representations.

2.2 Functional Modeling

The concept of functional modeling has been introduced and detailed in our previous work (Mokukcu et al., 2016). Unlike multi-physical modeling concept, in this methodology, functional links are employed to represent flow exchanges within the complex system. In a functional model, the flow can be either energy, either matter or both, and it is exchanged together with an information flow. The exchange of flow is made between five types of elements (source,

storage, distribution, transmission and effector), each of them having source and consumer ports. Source ports receive expressed *need* from consumer ports and they answer by supplying the requested *need*. In addition, consumer ports transmit demands of *need* to source ports. This gives the method its modularity. Brief information about the basic elements of functional modeling is given in Table 1. The functional model can be simulated using the Matlab/Simulink simulation environment with a functional modeling library, which contains all this basic elements.

Table 1: Element types of functional energetic modeling and associated functions (Mokukcu et al., 2016).

Source	Storage	Transformation	Distribution	Effector
Energy & Matter Source	Energy & Matter Storage	Energy & Matter Transformation in Different Domains	Energy & Matter Distribution	Represents Energetics Services

In a functional model, the *need* computation starts from the effector. For example, the need of energy for a plus-in hybrid electric vehicle (PHEV) is calculated by electrical auxiliary element or vehicle dynamics element (both of them effectors of the system). Then, the energy need is transmitted to storages or sources via distribution and transformation elements. Based on information flow, the storages and sources can decide whether they are able to provide the requested energy or not. Furthermore, distribution elements are used to manage the energy flow between sources and storages, and to supply the requested energy to effectors as an answer to their need. If a hotel water treatment system is considered, the *need* of water consumption is calculated by hotel consumer element (effector) and the hotel logistics element must supply the required amount of water, with suitable properties.

Fig. 6(a) illustrates an example of a functional model, which also represents an energy transformation (electrical energy into mechanical and thermal energy) but without considering the real physical behaviour. The model is described as below:

$$P_{mech} = \eta \cdot P_{el} \quad (5)$$

where P_{mech} denotes the mechanical output power, P_{el} is the electrical input power and η is the efficiency. Besides (5), maximum and minimum power limitations, P_{min} and P_{max} , are specified for each functional element. Moreover, these elements include the dynamic behaviour of the functional units. The dynamic behaviour is taken into account either by an integration for the energy-to-power transition, either by adding 1st (or 2nd) order transfer functions of the different elements such as transformations, storages or effectors.

The functional model allows fast simulations for system evaluation (sizing, architecture, requirements management) before choosing the technology, obtaining the GRM of multi-physical model and simulating the system as a whole. In the next section, the interconnection between functional and multi-physical modeling is presented, which comes to extract the GRM from the functional model.

3 INTERCONNECTION BETWEEN FUNCTIONAL AND MULTI-PHYSICAL MODELING

Functional modeling defines key-functions (FUs), allocates and refines end-mission requirements to the FUs and also defines the energy management system. On the other hand, multi-physical modeling defines the physical architecture or physical units, allocates and refines the functional requirements to physical units. To overcome the challenges associated with the control laws design and energy management within the entire system, functional and multi-physical models are interconnected. In this section, the difficulties related to the interconnection are presented along with the proposed solution. This solution is presented for the gear motor group and the electromechanical energy transformation that are introduced as examples in Section 2.

3.1 Problems of Interconnection

As presented in Fig. 4, the functional modeling level includes a control strategy that will be used by the control system of the multi-physical model. Moreover, this strategy is independent from technical components, and is defined according to the decision manager allocated from end-missions model.

In Fig. 7, a representation of control systems and

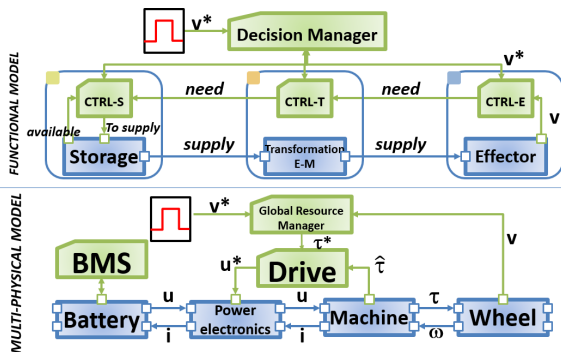

Figure 7: Control system and flow exchange representations of functional and multi-physical modeling.

flow exchanges of functional and multi-physical models is shown, for a battery electric vehicle (BEV). Here, the challenge is to find the adequate language to connect both models.

As flux exchanges are different between functional and multi-physical models, the connection cannot be done directly. Since multi-physical model components need physical domain references and functional model components require a power demand reference for simulation, connecting the power flow to physical domain flows can be a challenging task. At this stage, the interesting features of the interconnection can be expressed as follows:

- Functional modeling allows fast control architecture design and fast adaptation to eventual changes in the system,
- Multi-physical representation is too complex and time consuming when trials are accomplished.

3.2 Proposed Solution

A solution to the interconnection problem is to build an interface between the multi-physical and functional model. As illustrated in Fig. 8, this interface contains passage equations between physical domain and functional domain. It accomplishes the following functions: determine the equivalent physical references required for the multi-physical model based on the power demand provided by the functional model; measure/estimate the power supply that the system is able to deliver using information from the multi-physical model, and transfer the estimated power supply to the functional model. For each functional model element, an interface is required in order to calculate/adapt the necessary values.

If the electromechanical transformation element is considered, the interface between this element and

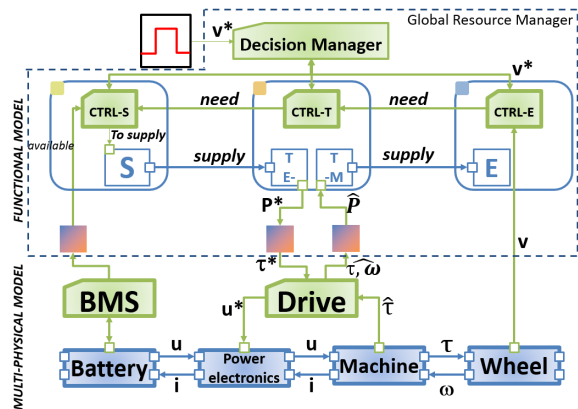

Figure 8: Functional to multi-physical domain interconnection.

electrical propulsion group (drive and electric machine in this example) uses the following equations:

$$\frac{P_{fnc}^*}{|\hat{\omega}_r|} = \tau_{cns}^* \quad (6)$$

$$P_{mech} = \hat{P}_{fnc} \quad (7)$$

where P_{fnc}^* denotes the power demand; $|\hat{\omega}_r|$ is estimated/ measured angular speed of rotor; τ_{cns}^* is torque demand; P_{mech} is calculated mechanical power of the electrical machine and \hat{P}_{fnc} is estimated/measured output power of the motor.

In the next section, an example of PHEV is presented. First of all, model architectures of functional and multi-physical models are given, and secondly, simulation results using the functional model and the multi-physical model with GRM are discussed.

4 APPLICATION EXAMPLE: HYBRID VEHICLE ENERGY MANAGEMENT SYSTEM

4.1 Motive

In a hybrid electric vehicle (HEV), and internal combustion engine (ICE) and one or several additional electric motors (EMs) are used for the vehicle powertrain. The ICE is supplied by fuel while the EMs are supplied by a battery. These components, usually allowing different possible interconnections, form a complex and challenging multi-source/multi-consumer system in terms of optimal control design and energy management. Both objectives of the design process have to satisfy several vehicle services like fuel consumption or comfort level. Although there are optimization methods applied on HEVs, they are implemented for a specific architecture of the HEV and they usually require a priori knowledge of the driving cycle. Thus, the problem is how to manage the power split that globally satisfies the vehicle services whenever the vehicle has a new task (Sciarretta and Guzzella, 2007) and/or the system architecture is reconfigured.

In this study, a parallel plug-in hybrid electric vehicle (PHEV) is considered due to the resemblance to a battery electric vehicle that has been highly investigated over the last few years.

4.2 Control Architecture

The functional model of the parallel plug-in hybrid vehicle has been developed in our previous work

(Mokukcu et al., 2016). The developed model, shown in Fig. 9, is used to compute the power split between the multiple sources of the system, for different configurations and missions of the vehicle. Moreover, it allows to evaluate the fuel consumption, maximum speed, maximum acceleration and regenerative braking power (Mokukcu et al., 2016).

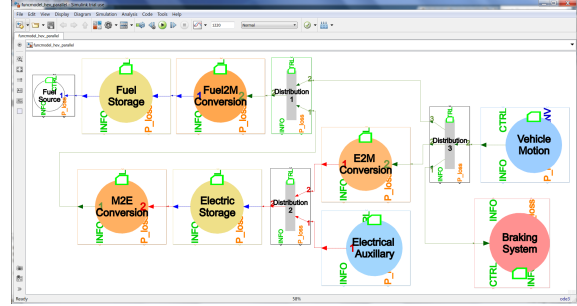

Figure 9: Functional model of PHEV (Mokukcu et al., 2016).

Thereafter, the next step in the design process is to use the information provided by the functional model (i.e. power signals for each source) for control design of a more complex multi-physical model. To this purpose, the power signals are transformed into physical reference signals using a unique interconnection element, which is added to each element of the functional model to adjust the flow nature, as shown in Fig. 10. Using this link, the functional and multi-physical models are able to exchange necessary values of power or physical references, as well as measured/estimated values.

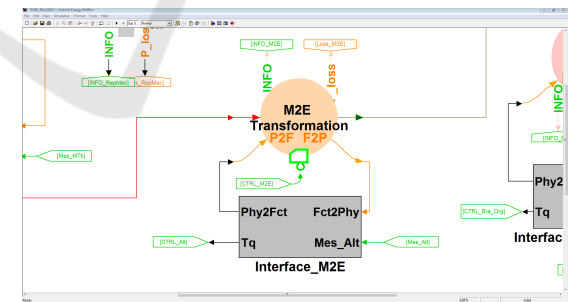

Figure 10: Functional model of M2E transformation element with its connection element.

The multi-physical model of the system is given in Fig. 11, where each component is a system itself. For example, Fig. 12 illustrates the representation of the electric machine subsystem.

As it can be noticed, the system architectures are similar in both functional and multi-physical models. Thus, if there is any change at multi-physical level, the functional model has to be adapted respectively.

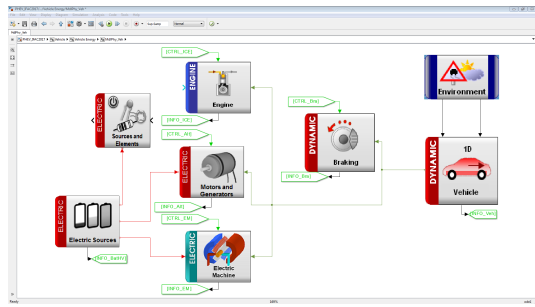

Figure 11: Multi-physical model of HEV.

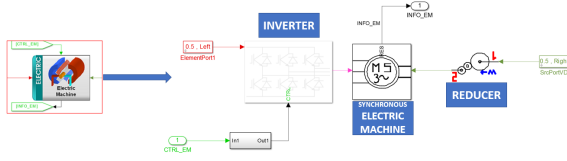

Figure 12: Electric machine component group.

4.3 Simulation Results

The simulations are run under the following assumption: the vehicle always moves forward. The model parameters are consistent with those of a parallel PHEV available on the market. Table 2 provides the technical characteristics of the vehicle.

Table 2: Technical characteristics of PHEV.

Technical Characteristic	Value
Fuel tank max. volume	45 l
ICE max. output power	70 kW @ 5000 rpm
ICE max. output torque	140 Nm @ 4500 rpm
Battery voltage	210 V
Battery capacity	50 Ah
EM max. output power	60 kW
EM max. output torque	200 Nm
Combined max. output power	100 kW
Vehicle curb mass	1500 kg
Vehicle SCx (Aerodynamic drag coeff.)	0.63
Vehicle wheel radius	0.635 m

To be able to compare the simulation results with the manufacturers brochure, the vehicle performance indicators are determined and their values are given in Table 3.

Table 3: Performance indicators of PHEV.

Performance data	Value
Combined consumption (WLTC cycle)	3.2 l/100 km
Electric drive range	25 km
Vehicle max. speed	180 km/h
Vehicle max. speed in e-drive mode	85 km/h
Vehicle max. acceleration (0-100km/h)	11.4 s

First of all, the functional model with its DM is simulated using the WLTC (Worldwide harmonized Light vehicles Test Cycle) that yields the vehicle

speed and the power demand illustrated in Fig. 13 (a), (b). In addition, the DM uses a ruled-based energy management strategy based on priorities, which is implemented in the distributor elements of the functional model. In this example, the functional model has three main distributors that are detailed in Table 4 with their priorities.

Table 4: Distributor priorities.

Priority No	Distributor 1	Distributor 2	Distributor 3
1	Drive	Electrical Aux	Electric Drive
2	Battery Charge	Drive	Fuel Drive
3	N/A	N/A	Brake System

Distribution 1 transmits mechanical energy supply from *fuel to mechanical* transformation element to *drive* or *mechanical to electrical* transformation elements. Distribution 2 transmits electrical storage energy supply to *electrical auxiliary* or *drive*. Distribution 3 transmits the energy need of *vehicle dynamics* to *electric drive* supply element or to *fuel drive* supply element or to the brake system.

The obtained results are also shown in Fig. 13. The vehicle speed and power achieve the desired profiles and meet the requirements of the WLTC. The regenerative braking can be observed between 1600s and 1800s in the Fig. 13 (c), (d). We remark that the vehicle speed on electric drive is limited to 85 km/h and the electrical storage/battery SOC (state of charge) is limited to %20; beyond these values, the electric drive is abandoned and electrical energy is consumed just by electrical auxiliaries.

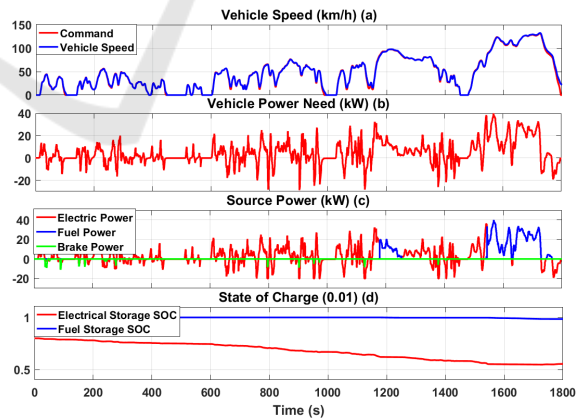

Figure 13: Parallel PHEV - simulation results using the functional model (Mokukcu et al., 2016).

These results represent a first validation of the chosen architecture of the vehicle and of the energy management strategy used to handle the power split within the system. However, at this level of abstraction, the energy model cannot generate specific physical signals such as electric motor output torque or

battery output current.

Simulation results of the multi-physical model and the proposed control architecture are illustrated in Fig. 14.

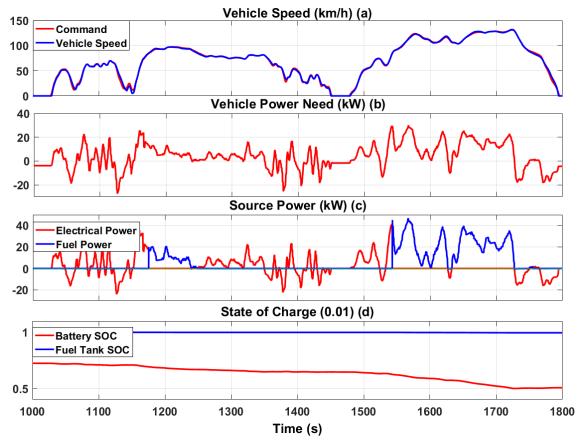

Figure 14: Parallel PHEV - simulation results using the multi-physical model with GRM.

According to Fig. 14, the following remarks can be made:

- Vehicle power need pattern is compatible with allocated source powers;
- When the vehicle surpasses 85 km/h (Fig. 14 (c)) the source power allocation moves to fuel source power, but at the same time battery SOC decreases (Fig. 14 (d)). The reason behind this is the constant electrical auxiliary load;
- A slight increase in battery SOC is seen at the end of the simulation showing the regenerative braking effect;
- Based on the parameters values shown in Table 2, the results are consistent with the physical limits of the components;
- From the acquired data, the fuel consumption can be calculated from following equation:

$$\frac{\Delta SOC_{Fuel}}{\Delta d} \cdot vol_{Fuel} \cdot 100 \quad (8)$$

For this test scenario (WLTC), the obtained fuel consumption is of 3.5l/100km. This result is well approximated by the value given in Table 3 (3.2l/100km). Besides the fuel consumption, power need and supply patterns have been compared. Slight differences can be observed due to the system dynamic behaviour, especially at time instants with negative power supply.

With the proposed solution, the system can be examined globally but also locally. Each component of

the vehicle can be investigated separately if the simulation model permits. Fig. 15 shows the electric machine results.

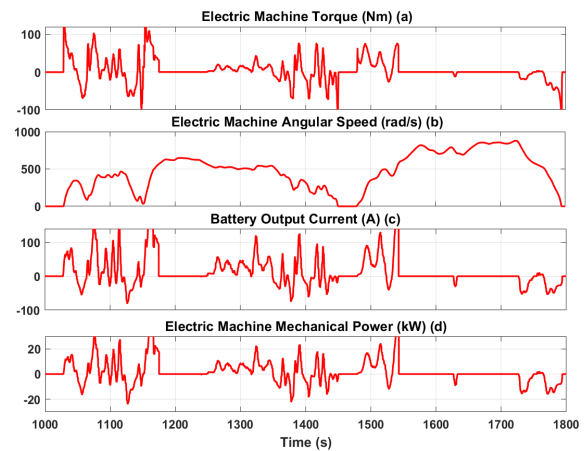

Figure 15: Hybrid vehicle electric machine results.

From the specific physical signals of the electric motor, the following comments can be made with information that is given in Table 2:

- Output torque values of electric machine are within its physical limits (maximum output torque is 200 Nm);
- The angular speed of the electrical machine follows the vehicle speed with a certain gear ratio;
- The electric motor current is between the physical limits with possibility of detailed analysis for regenerative braking (for example motor K_t (motor torque constant) value is approximately 1, which is acceptable);
- The electric motor mechanical power is illustrated in order to calculate the motor and generator efficiencies.

These results highlight the advantages of a multi-physical model with a GRM: detailed analysis of components, better precision and, therefore, reliable validation of simulations. Other physical components (ICE, auxiliaries, battery etc.) can also be analysed using the same simulation data. However, data exploitation depends on the multi-physical model complexity.

4.4 Additional Comments on Reconfiguration

A major advantage of the functional model is the ability to handle the system architecture reconfiguration without reviewing the analytical modeling, which cannot be avoided for a multi-physical representation of the system. If a component is added or removed,

the new configuration can be validated in a fast and efficient way. An example of this interesting feature is demonstrated in Fig. 16, highlighting the modularity of functional modelling. Compared to Fig. 9, an additional component is added to the system: a second electric machine used for traction.

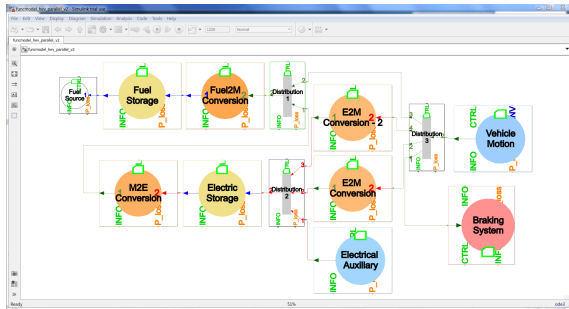

Figure 16: Reconfigured HEV model.

Therefore, with faster simulations compared to multi-physical modeling and ease of reconfiguration, the functional modeling becomes a very useful methodology for system modeling and simulation.

5 CONCLUSION AND FUTURE WORK

In the presented work, a methodology of modeling a control architecture was proposed using a functional energy-based approach. The methodology was applied to a PHEV with WLTC use case, using Matlab/Simulink simulation environment. The interconnection between functional model and multi-physical model serves to add a high level control to the multi-physical system representation. At functional level of abstraction, where the energy system exchanges need and supply, the energy management algorithms are easier and faster to adapt at this level of representation. Based on the functional model, the proposed concept simplifies the control design and computes appropriate multi-physical reference signals for the multi-physical model. A first perspective of the proposed modeling methodology is to establish a generalized method to interconnect the two levels of modeling.

Also, the simulated multi-physical model does not contain gear box for the ICE. The components (ICE or EM) models can be acknowledged as simple, which means that the dynamic behaviour of the system and its components cannot be thoroughly researched.

Future works intend to enhance the accuracy of multi-physical model (by improving the components models or by adding additional ones) in order to have

a more reliable validation. On the other hand, robustness of the control architecture will be further investigated.

Another perspective is to improve the energy management strategy used at functional level: more efficient algorithms for need/supply distributions should be developed and integrated into the simulation models for further validation. In this work, distributors use priorities for power need/supply distribution. For an optimal power split, an optimization-based energy management algorithm should be used.

Finally, the proposed method for control architecture design will be tested on different types of applications that need an optimal energy management like water treatment systems or building energy management systems.

REFERENCES

- Brunet, J., Flambard, L., and Yazman, A. (2005). A hardware in the loop (HIL) model development and implementation methodology and support tools for testing and validation car engine electronic control unit. Lecce, Italy. International Conference on Simulation Based Engineering and Studies, TCN CAE.
- Fauvel, C. (2015). *Approche modulaire de l'optimisation des flux de puissance multi-sources et multi-clients, à visé temps reel*. PhD thesis, Nantes, France.
- Fauvel, C., Claveau, F., and Chevrel, P. (2014). Energy management in multi-consumers multi-sources system: a practical framework. pages pp.2260–2266, Cape Town, South Africa. IFAC World Congress.
- Fiani, P., Taleb, L. A., Chavanne, S., and Mokukcu, M. (2016). Modélisation pour la conception et l'évaluation de systèmes complexes. *Revue Ingénieurs de l'automobile*, vol.841.
- Le Moigne, J. (1977). *La théorie du système général, théorie de la modélisation*. PUF, Paris, France.
- Mokukcu, M., Fiani, P., Chavanne, S., Taleb, L. A., Vlad, C., Godoy, E., and Fauvel, C. (2016). A new concept of functional energetic modelling and simulation. pages pp.536–541, Oulu, Finland. The 9th Eurosims Congress on Modelling and Simulation.
- Penalva, J. (1994). *Sagace: la modélisation des systèmes dont la maîtrise est complexe*. volume vol.94, pages pp.536–541, Montpellier. 2nd International Conference on Integrated Logistics and Concurrent Engineering (ILCE).
- Sciarretta, A. and Guzzella, L. (2007). Control of hybrid electric vehicles. *IEEE Control Systems*, vol.27:pp.60–70.
- Suh, N. (1998). Axiomatic design theory for systems. *Journal of Research in Engineering Design*, vol.10:pp.189–209.