

Parallel 1d3v Particle in Cell/Monte Carlo Collision (PIC/MCC) Simulation of a Glow Discharge Millimeter Wave Detector

Cemre Kusoglu-Sarikaya, Hakan Altan and Demiral Akbar
Department of Physics, Middle East Technical University, 06800, Ankara, Turkey

Keywords: Terahertz (THz), Glow Discharge Detector.

Abstract: Glow discharge detectors can be a good alternative to existing Schottky diodes, Golay cells and pyroelectric detectors because they are inexpensive and can detect mm-wave and sub-mm radiation successfully. This detection occurs as a result of the interaction of the radiation with the electrons in the plasma. It is required to understand this interaction mechanism to obtain optimum detection parameters. Previous methods have focused on understanding the interaction using analytical models, where the radiation is generally thought to increase the collision frequency of electrons in the plasma, however these theories were not tested against real discharge parameters. For that reason, in this study, the plasma formed inside the detector is simulated by using parallel 1d3v PIC/MCC code, which was previously developed (Kusoglu-Sarikaya et al., 2016) to better understand how the glow discharge forms under different pressure and gas concentrations. The effectiveness of the simulation is compared with mm-wave experiments performed on both commercially obtained and home-built glow discharge detectors. Initial results show that the 1d3v PIC/MCC code can simulate the discharge parameters that are observed in the measurements. Using this platform future studies will focus on understanding the effect of the sub-THz radiation on the collision frequency and observed parameters of the discharge.

1 INTRODUCTION

Technologies and applications that are based on mm waves (30-100GHz) have gained much attention recently. Historically, once a difficult region in the electromagnetic spectrum for the development of sources and detectors, their potential for use in civil and defense applications technologies have been driving research rapidly in the laboratory. One of the best commercial examples of their use has been in the development of imaging systems and their use in airport security screening areas. The use of these systems especially in the USA has made air travel even safer. One of the main disadvantages of these systems is that the sources and detectors used are still expensive to produce. Since mm-wave photon energies are on the order of meV and the background levels (blackbody) are typically high the methods used in the manufacture of the sources and detectors require advanced materials science development as well as cryogenic cooling which tends to increase the overall cost of these systems.

Current commercial direct detectors used to detect THz waves are Schottky diodes, Golay cells and pyroelectric detectors. However, these detectors are

expensive and have limitations in terms of speed and responsivity (Hou et al., 2011). One research area, first started in the 1970s, which was to use glow discharge lamps to detect THz and millimeter waves has become relevant again in the international arena due to the high interest in developing THz technologies. These recent studies show that glow discharge detectors (GDDs) have no such limitations as with other room temperature commercial detectors (Abramovich et al., 2007). Moreover, they are very cheap, which gives these detectors an extra advantage.

In order to understand the detection mechanism of GDDs, it is necessary to understand what is involved in the mm wave-plasma interaction. First, it is known that THz waves can penetrate through the plasma because the plasma frequency in the discharge tube (sub-GHz to GHz range) is smaller than the THz frequency (Kopeika, 1978). In addition, the mm wave radiation and the plasma are thought to interact in two ways: Cascade ionization and diffusion current (Kopeika, 1975). While this gives a broad understanding of the method of interaction, the physical phenomena resulting from this interaction which are observed in experiments have not been studied in detail. Thus how the radiation interacts with the

plasma is still not known exactly. Experiments performed by our group has shown that the mm wave radiation is detected by a change in the plasma current for commercially available discharge lamps, however the same experiments when performed with a home-built discharge chamber were inconclusive suggesting that gas composition, pressure as well as electrode composition all play an important role in the detection of the radiation (Alasgarzade et al., 2016). To better understand the role these parameters play the GDD simulated using the parallel 1d3v PIC / MCC code previously developed (Kusoglu-Sarikaya et al., 2016) and the results compared with controlled experiments performed in the laboratory. These results will aid in understanding the plasma parameters that dominate the detection observed with commercial detectors. This will be done later by adding the energy associated with the radiation to the plasma allowing to better understand the physical reactions of the particles inside.

2 GLOW DISCHARGE CHAMBER

Commercially available neon indicator lamps, namely glow discharge detectors (GDDs) have been our primary research interest since they are proven to be cost-effective, low noise, fast response mm-wave/Terahertz (THz) detectors (Rozban et al., 2008; Abramovich et al., 2007). Previously, we have investigated various GDDs in terms of their speed, frequency response and polarization dependence based on their orientation with respect to the incident light (Alasgarzade et al., 2016). In order to investigate contributing effects to mm-wave/THz detection mechanism such as the effects of discharge breakdown and glow scenarios for various inert gasses as well as various Penning mixtures, a small plasma vacuum chamber is designed and built, shown in Fig. 1 and Fig. 2.

A breakdown is achieved in gas mixture by applying a bias DC voltage to the electrodes. Under sufficient conditions the electric field of the modulated incident radiation increases the total electric field and can generate variations in the plasma current. The effect of incident radiation on the plasma current depends on several parameters such as plasma region, type of the gas mixture, electrode geometry and polarization of radiation. Based on the measured discharge current values, we expect to operate within the abnormal regime of the glow, before the arc region (Braithwaite, 2000). In this region the electric field of the incoming mm wave radiation, when aligned with the applied DC field is expected to increase the rate of excitation collision (Rozban et al., 2008).

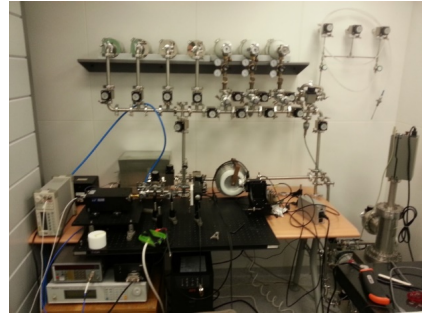

Figure 1: The gas mixer system designed and built to mix the inert gases inside the home-built chamber allows up to 3 different gases to mixed under normal (partial atmosphere) to low vacuum (0.01 Torr) conditions. The gases are mixed inside a housing before being sent into the chamber.

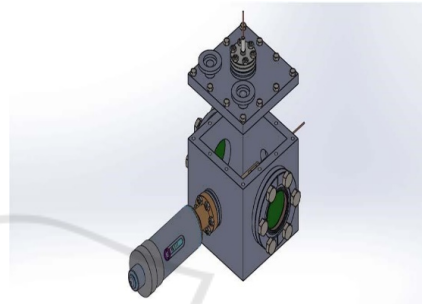

Figure 2: Plasma Discharge Chamber. The electrode separation is controlled using a micrometer.

The vacuum chamber having a dimension of roughly $10 \times 10 \times 10 \text{ cm}^3$, has two quartz windows with 40 mm diameter that allow the transmission of incident THz radiation through the DC glow discharge between the electrodes. Electrodes with different geometries can be used. The electrode separation can be controlled with $10 \mu\text{m}$ resolution and can be extended up to 2 cm. Also the chamber admits a floating probe allowing the measurement of changes in plasma current and plasma voltage. There are two feedthroughs on the top of plasma chamber. One of them is connected to the gas distribution system and the other is connected to the Multi-Gauge Controller (Varian) for measuring pressure inside chamber instantaneously. With the rotary vane pump system, the pressure inside chamber can be reduced to 10^{-2} torr.

After sealing the pump line, routine operations of plasma glow are achieved with a backfill pressure of 25 torr for pure Neon Gas (99.999%). The breakdown is achieved at around 350 V for a 1 mm separation between anode and cathode. Compared to commercially available Neon lamps these values are thought to be much higher. In commercially available Neon lamps typically discharges are obtained for breakdown voltages 80-150 V for similar electrode spacing and pressure. Thus the commercially available Neon lamps

are thought to contain a mixture of gases. In order to better understand the interaction of the mm wave radiation with the glow simulations were carried out to see if one could simulate the observed experiments.

3 MODEL

Parallel 1d3v PIC/MCC code, which was developed previously (Kusoglu-Sarikaya et al., 2016), is used to simulate the glow discharge detector by using neon gas and Ne-Ar mixture separately. This code includes elastic scattering, excitation and direct ionization processes between electrons and neutrals as in Fig. 3. Since it is well known that $Ne(^3P_2)$ is responsible for Penning ionization of argon gas (Kopeika, 1978), only the excitation which causes the formation of this metastable atom has been taken into account. Fluid approximation,

$$\frac{\partial n}{\partial t} - D \frac{\partial^2 n}{\partial x^2} = S, \quad (1)$$

is incorporated with the PIC/MCC numerical model to analyze the density distribution of $Ne(^3P_2)$ metastable atoms. Here, D is the diffusion coefficient and S is the excitation source term. Metastable neon atoms are assumed to be absorbed at the boundaries. The diffusion coefficient was taken (Phelps and Molnar, 1953; Phelps, 1959) as $150 \text{ cm}^2 \text{ s}^{-1} \text{ torr}$.

In addition, it is assumed that mainly isotropic scattering and charge transfer collisions occur between ions and neutrals and cross-section values are taken (Cramer, 1958) as 2×10^{-19} and $3 \times 10^{-19} \text{ m}^2$ respectively.

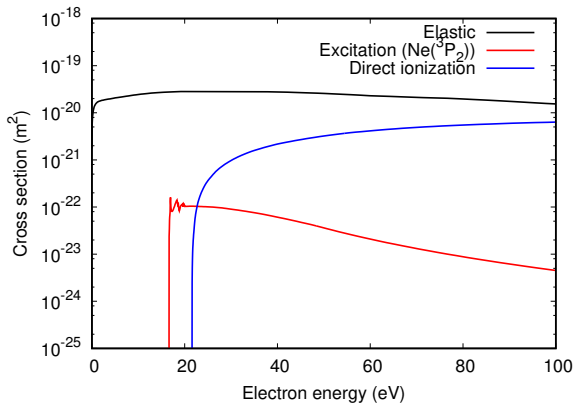
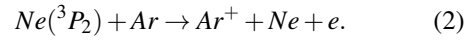

Figure 3: Electron cross-sections for elastic, excitation and direct ionization collisions in neon, used in the model. Cross-sections were taken from www.lxcat.net (Biagi (Magboltz versions 8.9 and higher)).

Simulation of the Ne-Ar mixture also includes Penning ionization reaction with the cross-section

(Fridman and Kennedy, 2004; Franz, 2009) of $1 \times 10^{-19} \text{ m}^2$,



Here, the ionization energy of argon is 15.76 eV and the energy of metastable neon atom is 16.62 eV. Thus, it is expected that electrons with an energy of 0.86 eV will form as a result of this reaction.

It is also known that the reactions occurring at the boundaries have an important role in the formation of plasma. Therefore, ion induced secondary electron emission and electron reflection are considered and they were assumed to have coefficient value of 0.2. Remaining parameters used in the GDD simulation are summarized in Table 1.

Table 1: The Parameters Used in the PIC/MCC simulation of GDD.

Species	$e, Ne^+, Ne(^3P_2)$
Weighting (10^8)	1
Grid Number	600
Time step (s)	1×10^{-12}
Distance (mm)	1
Neutral Temperature (K)	300
Pressure (Torr)	25
Voltage (Volt)	110

4 SIMULATION RESULTS (PURE NEON GAS)

Electric field and potential profiles can be seen in Fig. 4 and Fig. 5. According to these figures, the quasineutral region is between 0.1 and 0.5 mm. This quasineutrality can be seen more clearly in the density distribution profiles (see Fig. 6). In addition, the Cathode region appears near 1 mm with strong electric field.

Fig. 7 and Fig. 8 illustrate the mean energy distribution of electrons and ions between the electrodes. As expected, highly energetic particles are seen near the cathode. However, in quasineutral region, low energetic particles constitute the majority as the frequency of the collisions increases in this region. These low and high energetic particles cause the energy distribution function profiles to consist of two different regions (Fig. 9 and Fig. 10).

High electron current density and low ion current density are seen in Fig. 11 and Fig. 12. However, it is noteworthy that the electron current density is very noisy. This noise can be reduced by decreasing the weighting value of the super particle number.

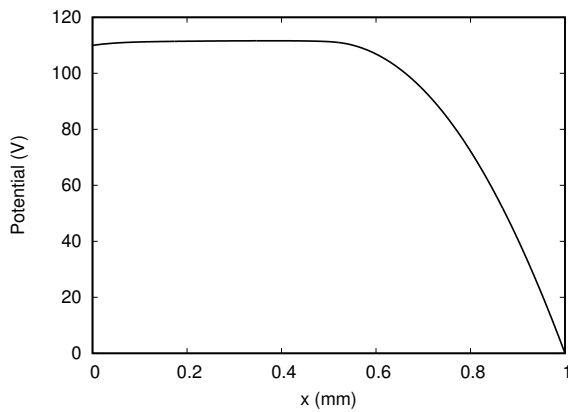

Figure 4: Potential profile obtained by using pure neon gas.

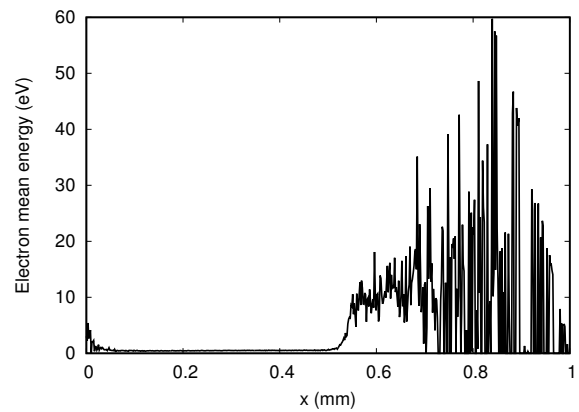

Figure 7: Electron mean energy distribution obtained by using pure neon gas.

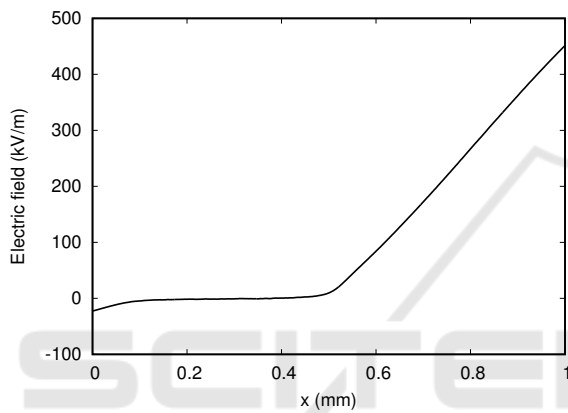

Figure 5: Electric field profile obtained by using pure neon gas.

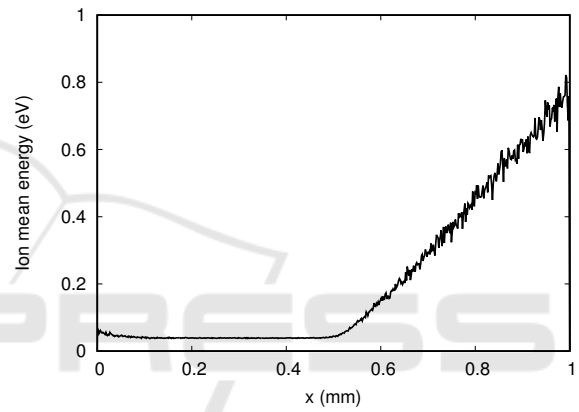

Figure 8: Ion mean energy distribution obtained by using pure neon gas.

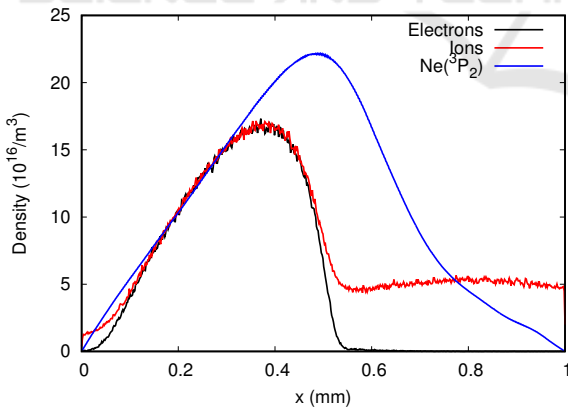

Figure 6: Electron, ion and metastable neon density profiles obtained by using pure neon gas.

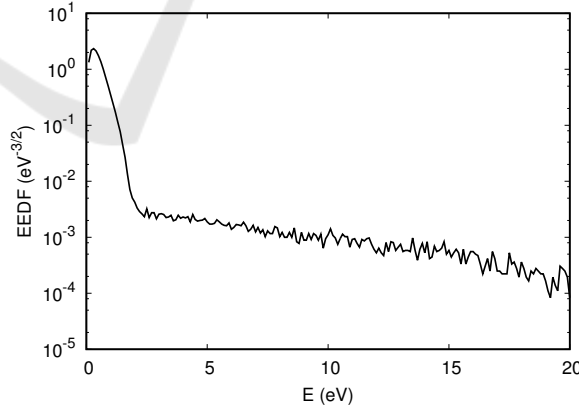

Figure 9: Electron energy distribution function as a function of electron kinetic energy obtained by using pure neon gas.

5 SIMULATION RESULTS (NEON-ARGON MIXTURE)

Simulation results were re-examined by adding 1 percent argon gas to the neon gas. For the Ne-Ar gas mixture (1% Argon, 99% Neon), a plasma could be

obtained at 110 Volts (as in pure neon gas). The increase in electron and ion density with the effect of Penning ionization is clearly visible in Fig. 13 and Fig. 14. Given this increase, it turns out that when a pure neon gas is used, a higher voltage is needed to achieve the same profile. This clearly indicates the

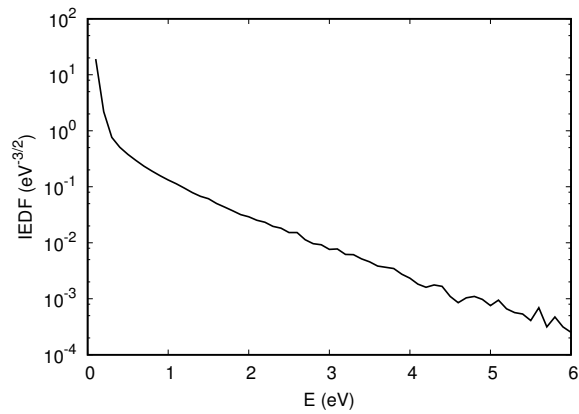

Figure 10: Ion energy distribution function as a function of electron kinetic energy obtained by using pure neon gas.

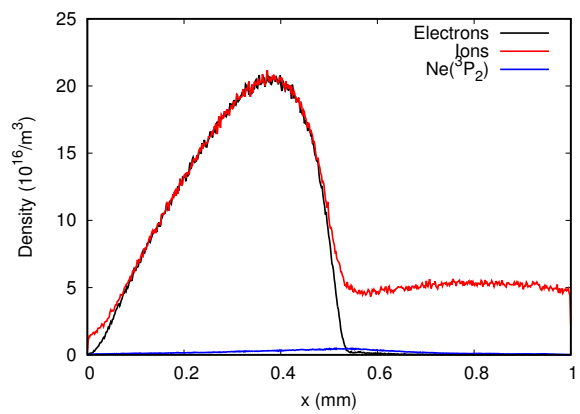

Figure 13: Electron, ion and metastable neon density profiles obtained by using Ne-Ar mixture.

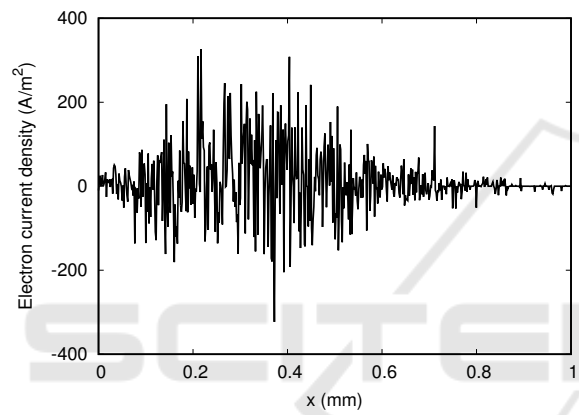

Figure 11: Electron current density obtained by using pure neon gas.

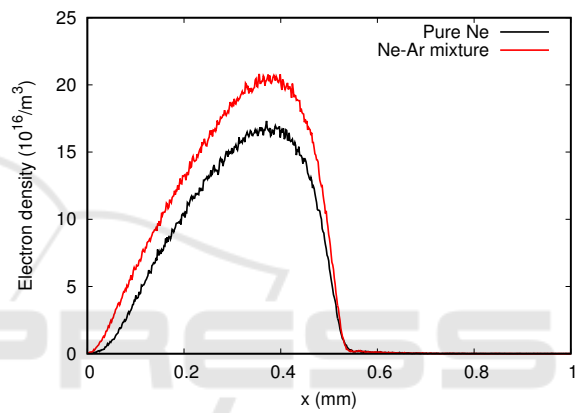

Figure 14: Comparison of the electron density profiles obtained by using pure Ne and Ne-Ar mixture, separately.

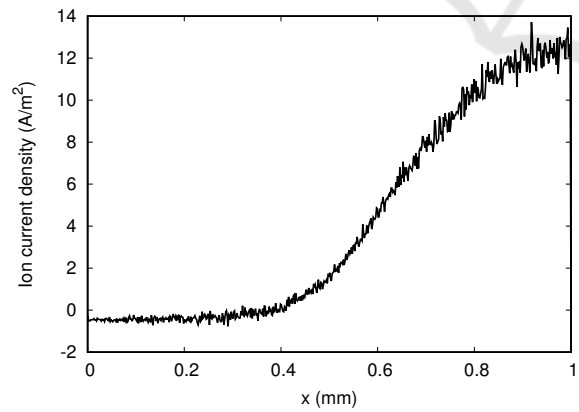

Figure 12: Ion current density obtained by using pure neon gas.

reason for the use of the Ne-Ar mixture.

6 CONCLUSIONS

Parallel 1d3v PIC/MCC (Kusoglu-Sarikaya et al., 2016) simulation of GDD filled with neon gas and Ne-Ar mixture is performed separately and compared with experimental results. It is seen that the simulation describes the observed experimental parameters adequately for the home-built glow chamber. Mixtures of gases reduce the required breakdown voltage due to Penning ionization and the obtained electron densities agree well with expected values. Future work will target the effect of mm wave radiation on the energy distributions of electrons inside the plasma. By obtaining an understanding of the parameters associated with the glow, better GDD structures can be designed and implemented for mm wave applications.

ACKNOWLEDGEMENTS

The work was supported by the Scientific and Technical Research Council of Turkey (TUBITAK) 115F226. The simulations were performed using High Performance and Grid Computing Center (TRUBA Resources) at TUBITAK ULAKBIM.

REFERENCES

- Abramovich, A., Kopeika, N. S., Rozban, D., and Farber, E. (2007). *Appl. Opt.*, 46:7207.
- Alasgarzade, D. N., Takan, T., Mansuroglu, D., Sahin, A. B., Uzun-Kaymak, I. U., and Altan, H. (2016). Interaction of a narrow gap glow discharge plasma with far infrared radiation. In *41st International Conference on Infrared, Millimeter, and Terahertz waves (IRMMW-THz)*.
- Braithwaite, N. S. J. (2000). *Plasma Sources Sci. Technol.*, 9:517.
- Cramer, W. H. (1958). *J. Chem. Phys.*, 28:688.
- Franz, G. (2009). *Low Pressure Plasmas and Microstructuring Technology*. Springer.
- Fridman, A. and Kennedy, L. A. (2004). *Plasma Physics and Engineering*. CRC Press.
- Hou, L., Park, H., and Zhang, X. C. (2011). *IEEE J. Sel. Top. Quantum Electron*, 17:177.
- Kopeika, N. S. (1975). *Proc. IEEE*, 63:981.
- Kopeika, N. S. (1978). *IEEE T. Plasma Sci.*, 6:139.
- Kusoglu-Sarikaya, C., Rafatov, I., and Kudryavtsev, A. A. (2016). *Phys. Plasmas*, 23:063524-1.
- Phelps, A. V. (1959). *Phys. Rev.*, 114:1011.
- Phelps, A. V. and Molnar, J. P. (1953). *Phys. Rev.*, 89:1202.
- Rozban, A. D., Kopeika, N. S., Abramovich, A., and Farber, E. (2008). *J. Appl. Phys.*, 103:093306.