

# Progression of Electronic and Communication System for Motion Control of Modular Snake-like-Robot

Daniel Armando Gómez, Javier Camilo Torres Vera and Hernando León-Rodríguez  
*Electronic Department, Faculty of Engineering, El Bosque University, Bogota, Colombia*

**Keywords:** Active Joint Mechanism, Snake-like Robot, Modular Master-slave Controller, Continuous Redundant Robot, Robotic Operating System.

**Abstract:** This Project consists of a development of an electronics system to manipulate a snake like robot in a modular way. The structure of this project is based on three topics; The Hardware and its Firmware, The Mathematical Analysis of the Serpenoid Curves and The Robotic Simulation. In regards to the first topic electronic cards were implemented in a master-slave relationship for joint control of each mechanical module, these cards are composed of a DSPIC30F4011, microchip 16-bit microcontroller that incorporates the CAN module, essential protocol for communication between cards, PWM outputs for motor control, analogue and digital ports; as well as a socket to connect to an external device through the UART. The firmware has been written in MikroC Pro. The mathematical analysis is based on the Hirose-Serpenoid curves, hence every microcontroller implements a characteristic equation from the Hirose curves to generate a serpentine movement and last but not least the snake like robot is simulated using ROS (Robotic Operating System) in Rviz.

## 1 INTRODUCTION

Nature is the best way to analyse and development bioinspired devices with different types of behaviors and locomotions for modeling. The anatomy of the snake is composed by the same type of union and structure where each vertebra allows a rotation in the horizontal plane of 10-20 degrees and a rotation between 2-3 degrees in the vertical plane. (Hopkins, 2009) The locomotion system of the snake is very stable and the body is in constant contact with the ground at different points, allowing a low centre of mass and great traction on several surfaces where it is easy to perceive its great ability to catch a prey or climb a tree with low energy consumption. The structural design of a snake is based on the repetition of its spine along its entire body, where only 3 types of bones make it up: the skull, the vertebrae and the ribs. The vertebral column is composed of between 100 and 400 vertebrae and each vertebra allows small movements in vertical and lateral direction, but the composition of so many vertebrae allows the snake a great flexibility and curvature with dramatically large forces.

Shigeo Hirose introduced Snake-inspired robots in the 1970s. (Hirose, 2009) Since then, several

numbers of bio-inspired designs about snake like robots have been conceived and constructed. Although, the numerous designs of robots follow the kinematics and locomotion imitating the snake, they can change enormously in their physical configuration and purpose. For example, some robots are redundant; others are hyper-redundant while others may not have redundancy at all. (Dowling, 1997) The first designs of snake-robots used traction wheels or tracks, while at present they can use passive wheels or without wheels at all. (Sugita, 2008) Some designs are amphibious and can move effortlessly between terrestrial environments and water. (Hopkins, 2009) (Yu, 2009) (Yamada, 2009) However, the demand for new types of robots is still present for rescue and inspection applications, where they do not require a robot capable of negotiating such conditions and difficulties in sewer lines, water networks and swamps. Robots based on thin and flexible snakes meet some of these needs. (Wright, 2012; Aksel, 2008; Ijspeert, 2007; Biorobotics, 2016).

Commercially, robots for exploration of pipes are of many kinds, where each one of them fulfils different functions, mainly that of visual revisions of the pipelines of drinking water and hydro-sanitary lines through video capture. However, the

technologies used by these robots are in many cases obsolete, because their use is purely industrial and the development and updating cycle is very slow. Some of the most important of them are reviewing in the manufacturer's bibliography. (Rausch Electronics, 2018) (Aries Industries, 2018) (Ibak, 2018) Those robots have a very large disadvantage in that most of them require a very expensive and heavy transport logistics and for inspection services where the cost of using this equipment makes its frequent application difficult.

According to the electronics and hardware features of Hibot company created at the Tokyo Institute of Technology in 2004 by Professor Shigeo Hirose (HiBot Company, 2018), has developed some robot controller such as: TITech M4 Controller and the TITech M4 Controller. The last one is designed based on the STM controller 32-bit ARM Cortex M4 at 168 MHz, it has LAN Ethernet, Can, SPI, I2C and UART interfaces, also its features include Digital I/O, A/D at 12 bits, D/A and 9axis motions sensor. Even USB and micro SD memory reader are available. On the other hand, this project developed an electronic system and control to manipulate a snake like robot with continues redundant active modules. The electronic cards implemented are pre-set as a master-slave controller that executes the joints control of each mechanical module. The figure 1 showing the main cards composed by one DSPic30F4011 microchip with 16-bit microcontroller that incorporates the essential communication protocol of CAN, PWM outputs for motor control, analogue and digital ports; as well as a socket to connect to an external device through the UART.

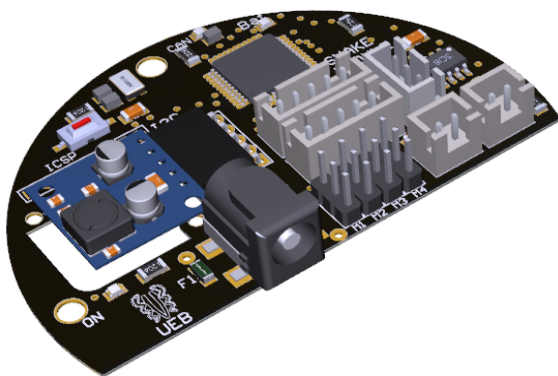

Figure 1: Photorealistic picture of the control card.

The aim of this project is to propose the basics with a low cost with different approaches for design of a snake like robot bio mimetically inspired with

passive wheel and similar hardware developed by HiBot. This paper intended to presents the design criteria for electronic system to control and manipulate the robots, in addition presents mathematical model analysis and simulation.

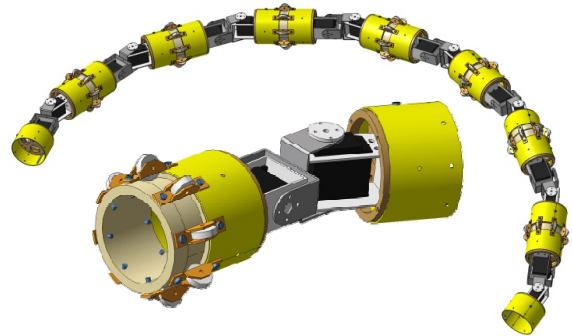

Figure 2: Conceptual design of modular snake like robot.

## 2 SERPENTINE LOCOMOTION

There are different types of locomotion in snakes based on the condition of the terrain and the type of environment. In the development of the project the cards and control can reproduce any of the 4 forms types of snake's locomotion presented in figure 3, however, the applications of the control system and the communications of the cards focused the serpentine locomotion, as verification of control system. (Rollinson, 2014).

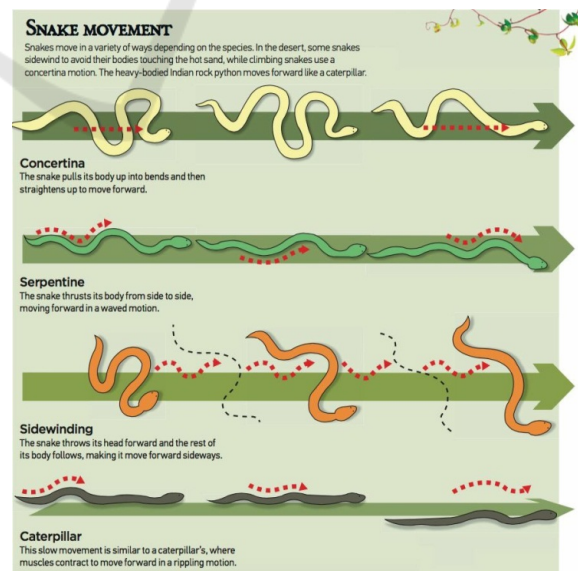

Figure 3: Kinds of snake locomotion. (Micu, 2018).

### 3 ELECTRONIC SYSTEM PARAMETERS

The conditions of the electronic design are based on the components necessary to generate the movement of the robot based on its locomotion, environment, size, current and application.

#### 3.1 Voltage Regulation

Due to the high efficiency of buck step-down type regulators, table 1 is showing the characteristics of the following devices that have been selected to satisfy current requirements of approximately 2.5 A.

Table 1: Step-down voltage regulator.

Product	Pololu D24V25F5	Pololu D24V50F5
V <sub>in</sub>	6 a 38 Vdc	6 a 38 Vdc
V <sub>out</sub>	5 Vdc	5 Vdc
I <sub>dc</sub> (max)	2.5 A	5 A
Efficiency	85% a 95%	85% a 95%
I <sub>dc</sub> in repose	0.7mA	0.8mA*
Inv. voltage protection	yes	yes
Size	17.8x17.8x8.8mm	17.8x20.3x8.8mm

#### 3.2 Microcontroller

The microcontroller selected was based on its 16-bit architecture; additionally, it has CAN communication protocol incorporated as a final purpose of control and position of the servomotors.

Table 2: Microcontroller parameters.

Parameter	Value
Architecture	16-bits
CPU speed	30 MPS
Type of minority	Flash
Memory	48 KB
RAM	2 KB
Temperature range	-40 a 125 °C
Operating Voltage	2.5 a 5.5 V
I/O Ports	30
Number of ports	40
Digital peripherals	2-UART, 1-SPI; 1-I2C
Analogue peripherals	1-A/D, 9x10-bits; 1000 kps
Protocol (#, type)	1 CAN
Capture/Compare/PWM	4/4
Resolution PWM	16 bits
PWM Channels	6
Parallel port	GPIO

#### 3.3 Power Requirement

The selected batteries are grounded on the power delivered, charging time and the space gap within of the modules. The selected batteries are lithium-polymer 72x34x14 mm 1000 mA, composed of two cells of 3.7 volts for a total voltage of 7.4 V.

#### 3.4 Communication Protocol

The proposed network protocol for internal communication between the electronic systems is a master-slave connexion. The CAN Bus was chosen, based on uses by the automotive industry due to its robustness protocol, which corrects transmission errors and its invulnerability to electromagnetic disturbances, thanks to its physical layer requirements that are a shielded in a differential pair.

### 4 MATHEMATICAL ANALYSIS

Based on kinematic analysis the behaviour and locomotion of a snake expresses the serpenoid curves and their joint trajectories as follow: (Hopkins, 2009) (Hirose, 2009) (Gong, 2015) (Grøttum, 2017)

Figure 4 is showing the Denavit Hatentberg joint orientation and analysis; considering that the robots is continues redundant all joints are identify in same way as represented in the figure 4. The table 3 listed the parameters of  $a_i$ : length of the module 22.5 cm,  $\theta_i$ : angles of rotation maximum limit of 60o degree and  $\alpha_i$ : joint orientation.

Table 3: Denavit Hatentberg designation.

Joint	$\theta_i$	$d_i$	$a_i$	$\alpha_i$
1	$\theta_1$	0	$L_1$	90°
2	$\theta_2$	0	$L_2$	-90°
3	$\theta_3$	0	$L_3$	90°
4	$\theta_4$	0	$L_4$	-90°
5	$\theta_5$	0	$L_5$	90°
6	$\theta_6$	0	$L_6$	90°
7	$\theta_7$	0	$L_7$	90°
8	$\theta_8$	0	$L_8$	-90°
9	$\theta_9$	0	$L_9$	90°
10	$\theta_{10}$	0	$L_{10}$	-90°
11	$\theta_{11}$	0	$L_{11}$	90°
12	$\theta_{12}$	0	$L_{12}$	-90°
13	$\theta_{13}$	0	$L_{13}$	90°
14	$\theta_{14}$	0	$L_{14}$	90°
15	$\theta_{15}$	0	$L_{15}$	90°
16	$\theta_{16}$	0	$L_{16}$	-90°

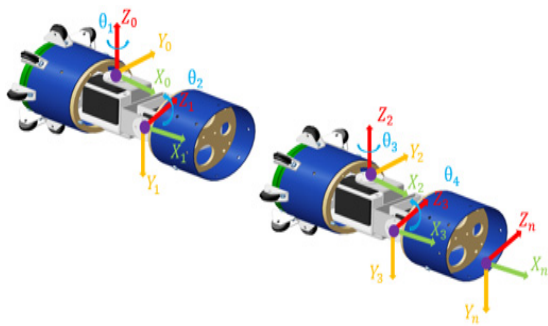

Figure 4: Denavit-Hatzenberg designation.

$$\beta = b/n \tag{3}$$

$$\gamma = (-c)/n \tag{4}$$

$$\alpha = 2a | \sin(\beta/2) | \tag{5}$$

As a result:  $i$ , is the number of the joint, that is, the first joint will have an equation with  $i = 1$ , the second with  $i = 2$  and so on.

## 5 ANALYSIS AND RESULTS

### 4.1 Serpenoidal Curves Analysis

The following equations express the serpenoidal curves proposed by Hirose. The length of the segment along the serpent is represented by  $S$ ;  $a$ ,  $b$  and  $c$  are parameters that determine the shape of the curve.  $\sigma$  represents the position of the curve,  $a$  specifies undulation,  $b$  periods and  $c$  the angular speed.

$$X(s) = \int_0^s \cos(a \cos b\sigma + c\sigma) d\sigma \tag{1}$$

$$Y(s) = \int_0^s \sin(a \cos b\sigma + c\sigma) d\sigma \tag{2}$$

These equations only describe a continuous curve, but actual snake robot has a finite number of links, that is why it is necessary to know the articular trajectories to imitate a continuous curve.

### 4.2 Articular Trajectories

The joint trajectories determine the angles that the joints must develop over time to generate a serpenoidal curve; these equations are those which are executed by the microcontrollers on each electronic card in order to control the angles of the servomotors. The equation (3) contains a new component  $\omega$ , which is determined by  $2\pi f$ , where  $f$  is the frequency with the curve generated by equations (1) and (2). (Mohammad, 2009) (Hirose, 1993) the equation 3 is mathematical derivative based on (1) (2).

$$\theta_i(t) = 2a \cdot \sin[(\omega t + (i-1)\beta) + \gamma] \tag{3}$$

Where: (4), (5) and (6) come from the same parameters  $a$ ,  $b$  and  $c$  of the serpenoidal curve,  $\omega$  indicates the speed of motion  $a$  is the amplitude,  $\beta$  specifies the phase shift between the joints and  $\gamma$  is a joint offset (Mohammad, 2009)

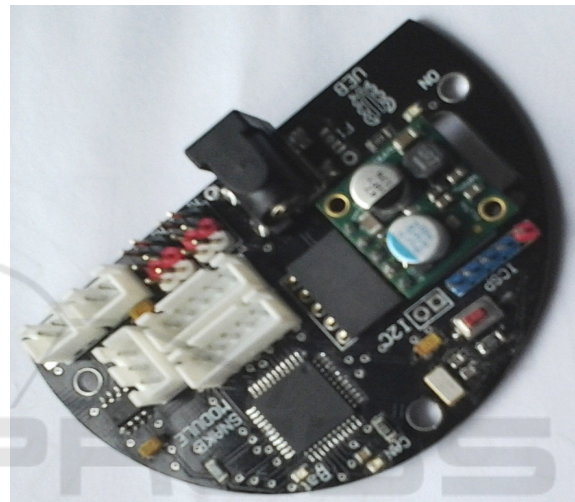

Figure 5: Master-Slave card developed.

The figure 5 showing the real electronic card implemented in each mechanical module of the robot structure. This card execute the master or slave control condition; the result is been done with a single card design allows to be configured as a master or slave according to the needs. Each card is

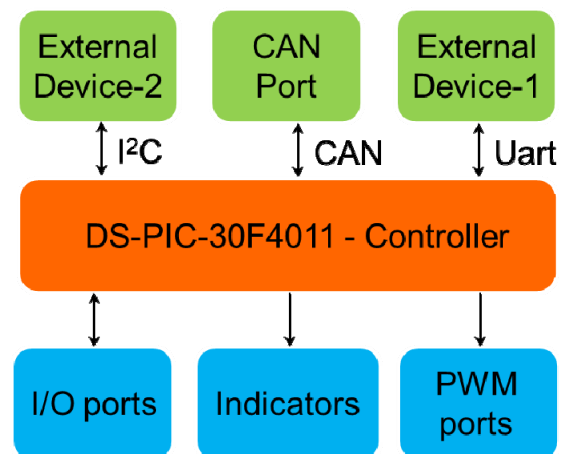

Figure 6: Block diagram of the electronic card.

identifying with an internal code that permits to know its location on the robotic structure.

The control and communication system of the developed card is presented in figure 6; this shows the diagram of any device with 5V supply voltage and logic, such as RF, Bluetooth, wifi modules that support the TTL/UART interface. The diagram also showing the following the communication protocols: CAN; UART, I2C that allow controlling any device such as sensors, servomotors, LEDs, etc. all them that support at the same time by the interface.

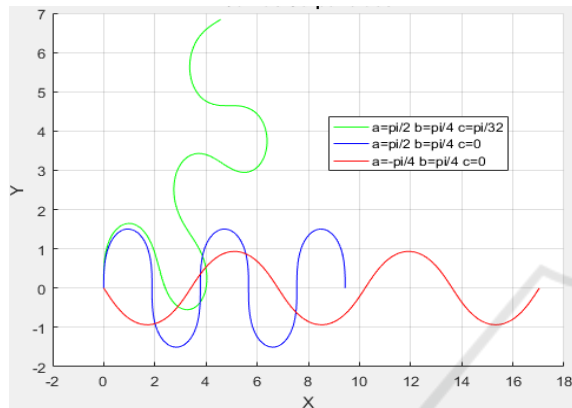

Figure 7: Simulation of trajectories behaviour and locomotion of the modular snake-type robot.

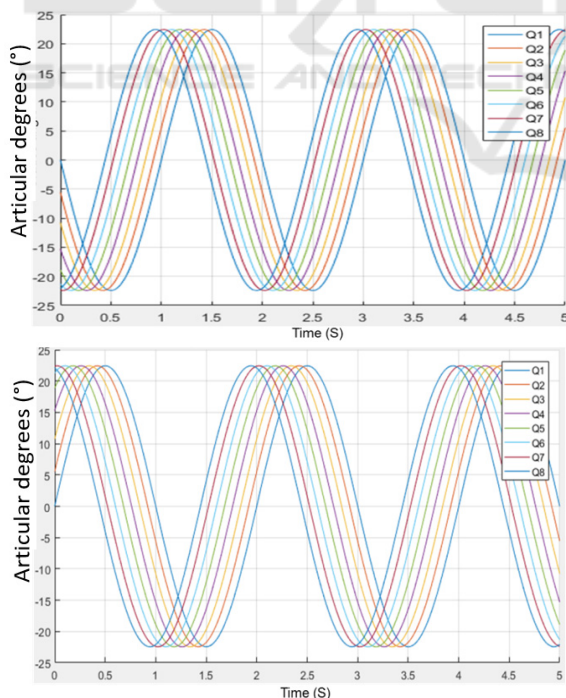

Figure 8: Top: Articular angles with respect to time:  $a=\pi/4$ ,  $c=\pi/2$ ,  $w=2\pi*(0.5)$ ; Bottom: Articular angles with respect to time:  $a=\pi/2$ ,  $c=\pi/2$ ,  $w=2\pi*(0.5)$ .

Figure 7 is showing multiple serpennoid curves generated by the modification of different parameters in control, such as: frequency, amplitude and phase shifting.

Figure 8 top, is showing the simulations of each joint of the robotic system covering the joint angles (Q1 to Q8) with respect to time with different parameters  $a$ ,  $b$  and  $c$ , based on equations 1 and 2. In addition figures 8 bottom is showing the path of each of the joint modules to complete the serpennoid curve; it should be notice that if these graphs were developed with  $N=7$ , (number of modules or links) the results would be similar.

## 6 SIMULATION OF ROBOT KINEMATICS

The simulation includes the implementation of the joint trajectories in the mechanical modules of the robot. As a result, the robot design has been taken to the URDF format compatible by the RVIZ simulator and through the publisher and subscriber of ROS. The described angles previously and the equations produce the simulated trajectories on RVIZ. (Sanfilippo, 2017; Stavadahl, 2017).

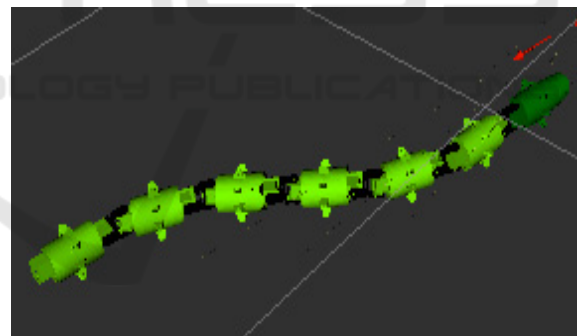

Figure 9: Result of robot simulation developing serpennoid curve in RVIZ-ROS.

The figure 9 is showing the executed simulation in RVIZ, in addition is validating that the robot could move in a serpentine way. However, in this first implementation, aspects such as the weight of the robot, friction and floor uniformity were not considered.

Figures 10 show the final implementation of the locomotion by the snake-like-robot based on the serpentine movements. Further research and work needs to be implemented in other to improve and produce uniform and soft motion for better performance. Nevertheless, the control cards with

CAN communications were well executed by the controllers, which were the aim of this preliminary research.

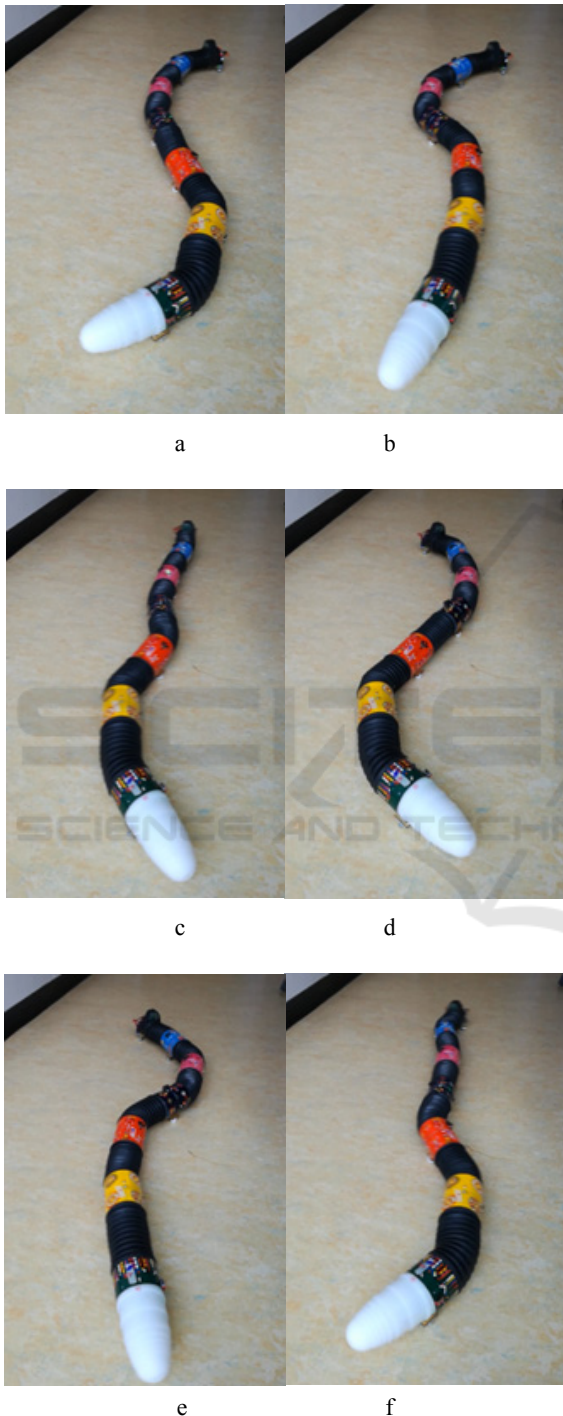

Figure 10: Motion sequence of robot like snake.

## 7 CONCLUSIONS

This project presents in a superficial way the design criteria for a particular electronic system to control a robot, these must cover its processing unit such as the microcontroller, its power supply and regulation, the peripherals must be contemplated, either that if we want to use sensors; it should follow the rules as those established in IPC-2221 to develop PCBs with high quality standards.

The project presents the importance of a mathematical analysis in terms of robotics and its respective simulation to check its effectiveness. However, there is a huge gap between the simulation and the real, since some physical variables did not contemplated precisely. For effective development of a robot, physical parameter such as torque of the joints is mandatory.

The advantage with this kind of development is that the design of the hardware and the robotic mechanism would conform to requirements of a particular application without exceeding the parameters of the criteria of design, which would compromise the budget of any project on the other hand, designing all the system will take more time to get the robot ready for its purpose.

Newer and more robust snake-robots, would get over the robots with active wheels for pipeline inspection, because of these robots do not rely on the wheel traction but the motion of its entire body, giving them the possibility to slither where wheels would get stuck.

## ACKNOWLEDGEMENTS

This project sincerely thanks the contributions made for the development of the control cards by the researchers: Michael Canu, Cecilia Murrugara; and especially to the Researcher Juan David Hernández of the University of Girona for his valuable contribution and knowledge in the management and control of ROS.

## REFERENCES

- Aksel A. Transeth, Remco I. Leine, Christoph Glocker and Kristin Y. Pettersen; 2008; 3D Snake Robot Motion: Nonsmooth Modeling, *Simulations, and Experiments*, *IEEE transactions on robotics*, vol. 24, no. 2, April 2008.
- Aries Industries; (Online accessed: march 13th 2018); <http://www.ariesindustries.com/>

- Biorobotics laboratory; (Online accessed: march 15th 2018); <http://biorobotics.ri.cmu.edu/projects/modsnake/>
- Dowling Kevin J.; 1997; Limbless Locomotion: Learning to Crawl with a Snake Robot, *The Robotics Institute Carnegie Mellon University and NASA Graduate Fellowships, December 1997*.
- Gong Chaohui, Travers Matthew J., Astley Henry C., Lu Li, Mendelson Joseph R., Goldman Daniel I. and Choset Howie; 2015; Kinematic gait synthesis for snake robots; *The International Journal of Robotics Research 1-14*, DOI: 10.1177/0278364915593793.
- Grøttum Stian Danielsen; 2017; Perception-Driven Obstacle-Aided Locomotion for snake robots, linking virtual to real prototypes; *Norwegian University of Science and Technology*.
- HiBot; (Online accessed: march 13th 2018); <https://www.hibot.co.jp/ecommerce/prod-detail/8>
- Hirose Shigeo; 1993; "Biologically Inspired Robots: Snake-like Locomotion and Manipulators", *Oxford University Press*.
- Hirose Shigeo and Yamada Hiroya; 2009; Snake-Like Robots, Machine Design of Biologically Inspired Robots, *IEEE Robotics & Automation Magazine, March 2009*
- Hopkins J. K., Spranklin B.W. and Gupta S.K.; 2009, A survey of snake-inspired robot designs. *Bioinspiration and Biomimetics, 4(2):021001*.
- Ibak; (Online accessed: march 13th 2018) <http://www.ibak.de>
- Ijspeert A.J. and Crespi A.; 2007; Online trajectory generation in an amphibious snake robot using a lamprey-like central pattern generator model, *Proceedings of the 2007 IEEE International Conference on Robotics and Automation (ICRA 2007)*, pages 262-268.
- Micu Alexandru; 2018; Research of snakes' straight-line movement could power the rescue bots of the future; (Online accessed: January 15th, 2018); <https://www.zmescience.com/science/snake-movement-straight-line/>
- Mohammad Dehghani; 2009; A Modified Serpenoid Equation for Snake Robots; *IEEE International Conference on Robotics and Biomimetics*; DOI: 10.1109/ROBIO.2009.4913248.
- Rausch Electronics USA; (Online accessed: march 13th 2018); <http://rauschusa.com/>
- Rollinson David; 2014; Control and Design of Snake Robots; *School of Computer Science Carnegie Mellon University*.
- Sanfilippo Filippo, Stavadahl Øyvind and Liljeback Pal; 2017; SnakeSIM: A Snake Robot Simulation Framework for Perception-Driven Obstacle-Aided Locomotion; *Proceeding of the 2nd International Symposium on Swarm Behavior and Bio-Inspired Robotics (SWARM), Kyoto, Japan*.
- Stavadahl Øyvind; Sanfilippo Filippo, and Liljeback Pal; 2017; SnakeSIM: a ROS-based Rapid-Prototyping Framework for Perception-Driven Obstacle-Aided Locomotion of Snake Robots; *Proceeding of the IEEE International Conference on Robotics and Biomimetics (ROBIO 2017)*.
- Sugita Saori, Ogami Kazunori, Guarnieri Michele, Shigeo Hirose, and Kensuke Takita; 2008; A Study on the Mechanism and Locomotion Strategy for New Snake-Like Robot Active Cord Mechanism-Slime model 1 ACM-S1, *Journal of Robotics and Mechatronics Vol.20 No.2*.
- Wright Cornell, Buchan Austin, Brown Ben, Geist Jason, Schwerin Michael, Rollinson David, Tesch Matthew, and Howie Choset; 2012; Design and Architecture of the Unified Modular Snake Robot, *2012 IEEE International Conference*.
- Yamada Hiroya and Hirose Shigeo; 2009; Study of a 2-DOF Joint for the Small Active Cord Mechanism, *2009 IEEE International Conference on Robotics and Automation Kobe International Conference Center, Kobe, Japan, May 12-17, 2009*.
- Yu Shumei, Ma Shugen, Bin Li, Wang Yuechao; 2009; An Amphibious Snake-like Robot: Design and Motion Experiments on Ground and in Water, *Proceedings of the 2009 IEEE International Conference on Information and Automation, June 22 -25, 2009, Zhuhai/Macau, China*.