

# An Adaptive Light Algorithm for Extracting Track Information and Its Control

Dong Liu and Yujun Wang

*School of Computer and Information Science, Southwest University, Chongqing 400700, Chongqing, China  
(mail:1617400837@qq.com phone number:13407279166)*

**Keywords:** Unpowered vehicle, path tracking, PID algorithm.

**Abstract:** On the path-tracking problem of autonomous vehicle and the extraction threshold of track, which is affected by the light, An unpowered intelligent vehicle and the corresponding control algorithm are designed in the paper. First, the vehicle's mechanism is designed. Then, some structures for mounting the camera and the steering gear are optimized. Next, the camera named LQ1286 is used to detect the path information in which the algorithm is adapted for image binarization processing that extracting the white line for track recognition. Following, PID algorithm is designed to adjust the angle of the steering servo mounted on the vehicle which is driven forward by external fan wind. Thus the patrol is completed intelligently. Experimental results show that the design of intelligent vehicle is able to complete the desired objectives.

## 1 INTRODUCTION

In recent years, energy and smart cars have become the hotspots of scholars abroad. We encounter the issue of combining energy and vehicles everywhere in our daily life. All energy comes from nature, in the past, we mistakenly believe that energy are excessive and consume them too much. The car occupies a large proportion of energy consumption, in order to solve this problem, human beings need to use sustainable energy. A non-powered car that this paper design can identify the path and just to meet this requirement. Furthermore, wind power generation has become the main form of wind power utilization, which is valued by all countries and develops quickly. Wind power usually includes three modes of operation: First, an independent operation, usually a small wind turbine to provide electricity to one or a few households, it uses battery energy storage to ensure that the wind-free electricity; the second is that the wind Power generation is combined with other power generation, such as a diesel generator, to power a single unit or village or island. Third, wind power is integrated into regular grid operations to provide electricity to the grid. Often a wind farm installed dozens or even hundreds of wind turbines, which is the main direction of wind power. In view of the hot issue at home and abroad, this paper proposes to use the external wind force to

enable the car to run autonomously on mountain roads, hillsides and hills, and then automatically install the fan on the car to the corresponding pole through the cart.

At present, some people have designed a controllable speed car, such as Freescale's competition, through the PID algorithm and the collection of the track information collection, you can quickly complete the specified track patrol line. However, they have not taken into consideration the problem of patrolling the car without power and the method of extracting the track using an adaptive environment. The designed car can only walk in the stadium of the match. As another example, someone designed a solar-powered car that can convert clean energy solar power into a car's power. But their research is still based on people's driving forward, and did not consider how to make the car automatically. The car designed in this paper has been tested experimentally and can achieve the expected goal.

In this paper, a controller based on PID algorithm and the algorithm of extracting track based on adaptive light are designed. After collecting information through the camera, the center of the track is obtained. After the data is controlled by discrete PD, get the Control amount. After experimental verification, the car can meet the expected requirements.

## 2 THE DESIGN OF MECHANICAL SYSTEM AND ITS IMPLEMENTATION

### 2.1 The mounting mechanism of servo

The car is mainly composed of the rear wheel, front wheel, camera and car bracket (for the installation of fan), as shown in Figure 1.

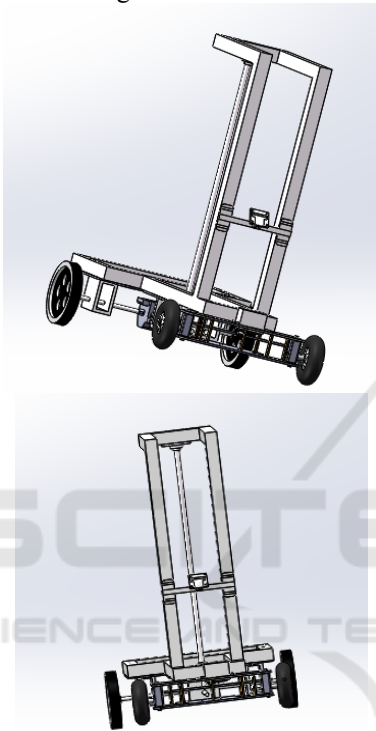

Fig.1 Simplified model of unpowered car

Taking into account the rules of the game said that only one steering mechanism can be used, we have a larger adjustment of servo mechanism. The steering of racing car is realized by the driving left and right tie rods. The servo rotation speed and power is certain, in order to speed up the response speed of the steering mechanism, the only way is to select the servo installation location and its length of the rod reasonably. As the power is a function of the speed and torque, under the premise of constant power, the excessive pursuit of speed will inevitably take the loss of torque and the torque is too small will also cause the steering to be slow, so this design considering the response speed of the steering mechanism and the steering gear. Based on the collection of physical parameters, the final parameters and structures that can work stably and

efficiently are obtained. After calculation and optimization, the designed servo gear (steering rod), taking into account the relationship between speed and torque, so that the installation is easier. The installation of the steering gear mechanism is shown in Figure 2.

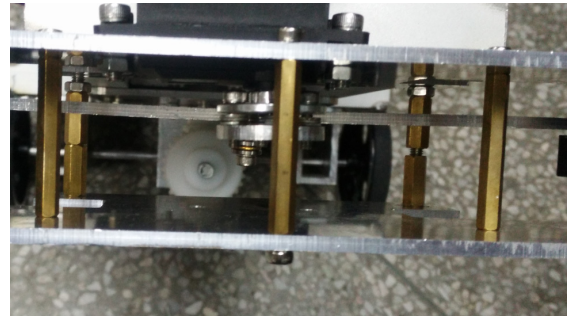

Fig.2 The structure of steering engine

### 2.2 Camera mounting mechanism

For the installation of the camera, we used a 3D printer to print a stand, so that we can easily replace the camera. We will install the camera in the center of the car, and the camera is not far from the track, so the camera can collect the information more intensive, and the information collected is not distorted. As shown in Figure 3.



Fig.3 The structure of camera

### 2.3 Power source - fan

Because the competition requires that the car itself can not carry any power source which can make it move forward, and the car is not allowed to move on in the final stage of the journey. Therefore, we use the channel fan to blow the car, the model of Channel fan is shown in Figure 4.

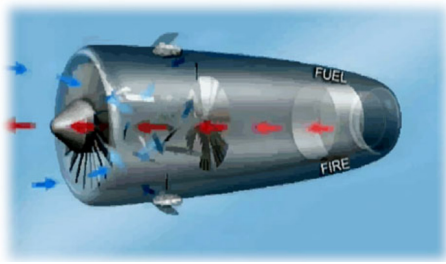

Fig.4 the channel fan

### 3 THE DESIGN OF PID CONTROLLER AND ADAPTIVE LIGHT ALGORITHM

#### 3.1 The Introduction of PID Control

In engineering practice, the Controller which is widely used is proportional, integral, differential control, referred to PID control. Because of its simple structure, good stability, reliable, easy adjustment and other advantages, PID controller has become one of the major technologies in industrial control. When the structure and parameters of the controlled object can not be completely mastered, or the precise mathematical model can not be obtained, the structure and parameters of the system controller need to be determined by experience and on-site commissioning. At this time, it is most convenient to apply PID control technology. PID controller's basic working principle is shown in Figure 5.

#### 3.2 PID setting and feedback acquisition

For the track, this article mainly through the linear camera to collect information, then make the information binary processing. That is, for different colors, the values collected by the cameras are different. In this paper, the formula (1) is used for processing, and the processed trajectory information is shown in FIG. 6.

$$f_{(x)} = \begin{cases} 1(\eta > (\max - a)) \\ 0(\eta < (\max - a)) \end{cases} \quad (1)$$

#### 3.3 Adaptive environment for extracting white track

##### 3.3.1 Adjust the exposure automatically according to the environment

Because the linear CCD will lead to great changes in the analog acquisition caused by Ambient light, so we must adjust the amount of exposure according to the light intensity, so the camera will not be saturated under strong lighting conditions. The specific algorithm is as follows:

First of all, by getting the maximum value of the algorithm, we calculate the maximum of 128 sets of data, as max.

If  $\max > 4096$

Note: 4096 is the maximum when the linear CCD is on saturation, this value can be reduced based on the actual situation.

If  $\max < 1200$

Increase the amount of exposure

##### 3.3.2 Get the value of $\alpha$

Through many experimental measurements, we found that when the value of  $\alpha$  is 70, and the length of the white track is about 3.

##### 3.3.3 Get center of the track

According to the maximum max, combined with the formula (1), we binarize the data to get the center of the track.

$$center = i + j / 2 \quad (2)$$

Where  $i$  is the start of the white track,  $j$  is the length of the white track,  $center$  is the center of the white track.

After calculating the center point of the track, the deviation between the center point and the center point is obtained, which is shown in equation (3).

$$e_{(t)} = (center2 - center1) / \alpha \quad (3)$$

$\alpha$  is the distance between two acquisitions,  $t$  is signs.

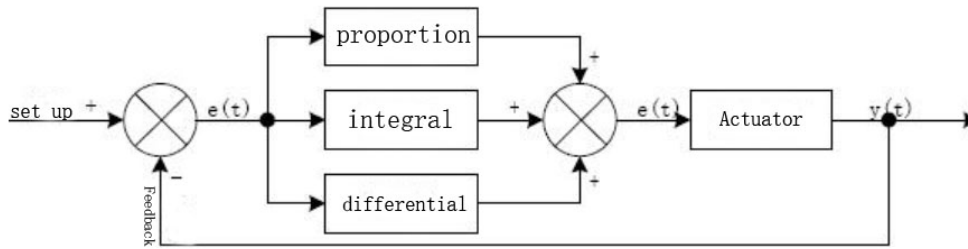

Fig.5 the block diagram of PID

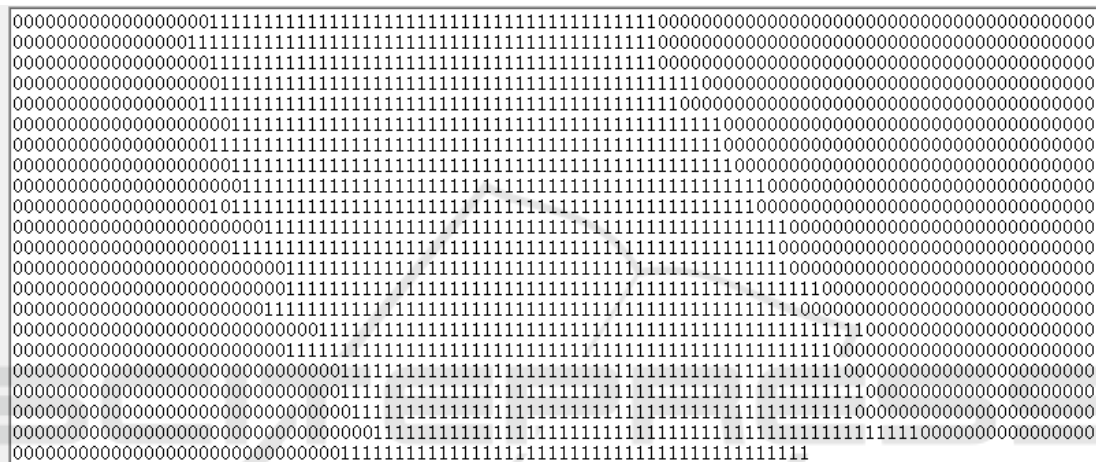

Fig.6 the trajectory's information

Through the previous steps, we can get the control of steering servo by PD control, as formula (4).

$$u_{(k)} = k_p e_{(k-1)} + k_d [e_{(k-1)} - e_{(k-2)}] \quad (4)$$

Where  $e(t)$  is the error function, where the error is twice. So far the control of the steering gear is obtained, and the control of the steering gear can complete the designated track task.

### 3.4 Method of crossing the crosshairs

Figure 7 is the "T" word line track which is required in race. For the "T" or "ten" shape track, this paper adopts the white track width to distinguish, that is, when the camera detects the width of the white line is greater than a threshold, then the program automatically determine the cross, Turn left directly.

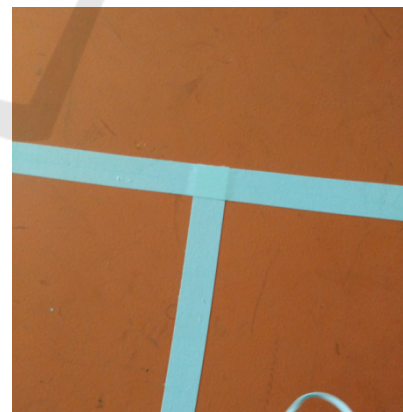

Fig.7 the T type line

## 4 THE RESULTS AND ANALYSIS OF EXPERIMENT

### 4.1 Parameter initial setting

In the experiment, we will make parameters  $k$  matched to the camera and the track information through linear conversion, so the parameters will be the same. Since the system is a linear system, the information detected by the camera will be the same as the servo should have at this moment. The specific principle is shown in Figure 8, the steering gear parameters  $n$  and  $l$  is a linear relationship.

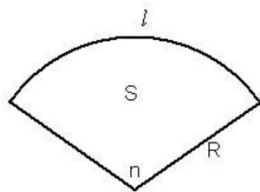

Fig.8 the picture of theory

The initial simulation by Matlab, the simulation is shown in Figure 9. Simulation diagram abscissa camera to collect the white track midpoint and the program control the servo one by one, just to meet a linear functional, and it meets with the analysis in Figure 8.

the results of Simulation show that when the camera detects the mid-point of the track, the value of the steering gear is just the corresponding midpoint, so from the previous analysis, the parameter setting is reasonable.

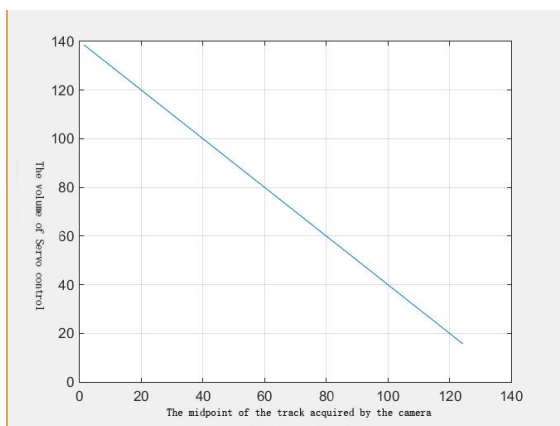

Fig.9 the simulation

### 4.2 The test on Real track

The experimental process is shown in Figure 10 and Figure 11.

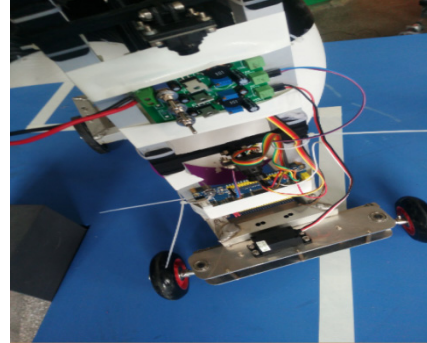

Fig.10 Passing the T type line



Fig.11 passing the broken line

In the experiment, the hand-push method is used to drive the car to move forward. When the car passes the T-shaped track as shown in FIG. 10, the camera can correctly identify the T-shaped track, and the steering wheel can automatically turn left. When the car through the track as shown in Figure 11, the car can be very good to make the broken line as a curve to travel. The car can successfully complete the game requirements, after testing, the program designed in this paper, can complete the desired line mission.

## 5 CONCLUSION

For the task of autopilot line, we transform the Right angle polyline into non-right-angle broken line, and then the program is combined with the PID algorithm for precise control of the steering wheel. Finally the car that we design can basically achieve the control of smart vehicles tasks.

We will consider the following aspects to improve:

- a) Reduce the mass of the car so that the car can run faster with the same wind force.
- b) Use color sensor. As the camera is susceptible to environmental interference, the use of color-coded sensors can improve the stability of autonomous patrol line.
- c) Optimize the camera's perspective so that it has the ability to anticipate the track.

## REFERENCES

- Tao Yonghua. The new PID control and its application [M]. Machinery Industry Press, 2002.
- Huang Yourui, Qu Liguang. PID controller parameters tuning and implementation [M]. Science Press, 2010.1.
- Zheng Archie .MATLAB Tutorial [M]. Electronics Industry Press, 2014.11.
- Zhao Jingbo .MATLAB control system simulation and design [M]. Machinery Industry Press, 2010.8.
- Liu Ke Yi, Schubert, Xu Guoqiang. The seventh smart car Beijing University of Technology camera group experiment report [J], 2013.4.
- Yin Jianhong, Wu Kaai. Graph theory and its algorithm [M]. China University of Science and Technology Press, 2003.
- Tan Hao strong. C programming [M]. Beijing: Tsinghua University Press, 2003.
- Yan Shi. Digital electronic technology foundation [M]. Beijing: Higher Education Press, 2000.
- Zhuo Qing, Huang Kai Sheng, Shao Beibei and so on. Learn to make a smart car - challenge "Freescale" cup [M]. Beijing: Beijing University of Aeronautics and Astronautics Press, 2007.3.
- Zhang Youtong, Chen Baojiang. Automotive electronic technology principles and applications [M]. Beijing: Beijing Institute of Technology Press, 2006.
- Shao Beibei. Embedded real-time operating system [LC / OS-II (second edition) [M]. Tsinghua University Press, 2004.
- The 15th RoboCon National University Robot Competition in 2016.  
<http://www.saikr.com/cnrobocon>