

# Gamelan Listrik: A Low-cost Solution to Introduce Javanese Gamelan to the Young Generation

Petrus Sutiyasadi

*Politeknik Mekatronika Sanata Dharma, Yogyakarta, Indonesia*

**Keywords:** Gamelan listrik, javanese gamelan, electric gamelan, midi gamelan.

**Abstract:** This paper offers a new design of electric musical instrument that called Gamelan Listrik. Gamelan Listrik is designed to be a low-cost instrument that can be used to play Javanese traditional music ensemble. A set of traditional gamelan instrument is very expensive. This makes only a few elementary schools own gamelan instrument and causes only a few numbers of students who know the instrument or even able to play it. Gamelan Listrik is proposed to be the solution of this matter. Using the gamelan Listrik, an elementary school can develop a gamelan class where the students can learn basic playing of the instrument and gain experiences. The most important thing is the students will have opportunity to develop their motivation in their early age. Experiments showed that Gamelan Listrik performed satisfactorily. It has small latency and the sound volume can be controlled by varying the mallet hitting/striking force to mimic the real gamelan playing. The cost of gamelan listrik is about 1/10 from the cheapest low quality of real gamelan made of iron, or about 1/100 from good quality made of bronze.

## 1 INTRODUCTION

The word gamelan is derived from the word “gamel” which means to strike or to handle (Sumarsam, 1988). It refers to a music ensemble of Java or Bali Indonesia that has metallophones at their core (Johnson, 2008). Gamelan will produce its tone when it is struck with mallet except the percussion called kendhang that played by hitting using our palm or fingers, zither types of instrument, and flute. Gamelan is a cultural heritage that should be preserved. Some researchers mentioned that gamelan is popular in many countries as an ensemble to be played (Wardhana et al., 2015). Besides, gamelan music can be used as a good method to reduce labor pain (Resna et al., 2017) (Ismail, 2011) until emotional therapy in prison (Mendonça, 2010). Nonetheless, only a few people especially in Java who play gamelan and it became less popular among the young people (Purbayekti, 2011). Young generations nowadays are rarely knowing this kind of instruments because they do not easily meet this kind of instrument whether at school or at their neighborhood. There are some reasons that make gamelan is a bit hard to be learnt (Kurniawan and Syarif, 2013) (Wijaya, 2015) such as: 1) The size of

gamelan is not flexible, 2) Normally gamelan is played in team, cannot be played individually, 3) The price of gamelan set is very expensive, 4) Gamelan needs a special maintenance, and 5) Gamelan needs a large of space.

There were some researches tried to overcome this situation. One method is using tablet or smart phone installed with application that can produce gamelan instruments sound (Hesananta, 2018) (Sumirat, 2014). Other projects are using laptop instead of tablet or smart phone (Kurniawan and Syarif, 2013) (Wiriadjaja, 2013). Commonly those researches tried to produce gamelan sound that can be played from the device interface whether it is using touchscreen, button from the keyboard, or any hardware designed to trigger the sound. All the projects may have resolved the highly cost, size, and flexibility problem. However, by using the devices produced from the researches mentioned above, the player still loses the real sensation in playing gamelan since they omit the role of the mallet. Secondly, the previous researches designed a single instrument for a single player. It means if we want to play in group, we need to duplicate the whole device. Consequently, the cost will increase proportionally.

This paper offers a new design of electric gamelan that may reduce the learning problems mentioned

above. It still incorporates the mallet striking so the player gets the real sensation of playing gamelan. The design is very efficient in size and price as well. When playing in group, we just need to duplicate the embedded system and the gamelan input device only. While the sound engine still relies on a single PC. When the student wants to practice in solo, the design supports individual playing or practice with digitally pre-programmed accompaniment. It can be used as an alternative method to teach gamelan in school with many benefits that were not easy to do before.

## 2 GAMELAN DESIGN

This section will explain the overall design of the system including the mechanic, electronic, and software design. The main block diagram of the system is shown in Fig. 1 below. Suppose there are 10 instruments, all those instruments are connected together through a USB hub. The signals from the hub are sent to the PC or laptop through a USB port. Kontakt free player is installed in the PC to receive all the instrument signals that have been mapped to several midi channels. The midi signals converted to audio sound by the Kontakt free player software. The quality of the sound amplifier and the speaker have a large influence to the quality of the final gamelan listrik sound.

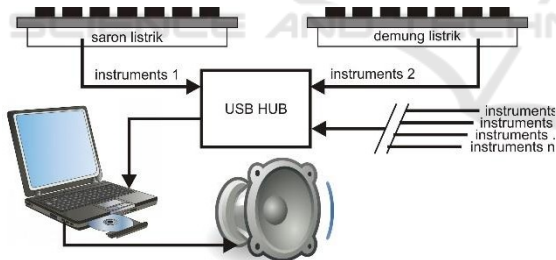

Figure 1. Block diagram of the system

### 2.1 Mechanic Design

The mechanical design actually will not be the same among different instrument. For example, saron and bonang are physically different in shape, therefore the design of the instrument is also different. Saron is made from several metallophones' plates. To mimic the plates, we used hard sponge. Mechanical design of saron is shown in Fig. 2. The thickness of the first layer of the sponge is 1.2 mm. After the sensor is attached, we put 5 mm thick hard sponge to cover it. The next layer should be soft enough so it will not deliver the vibration from one plate to the others.

Later as the base we use harder material such as particle board.

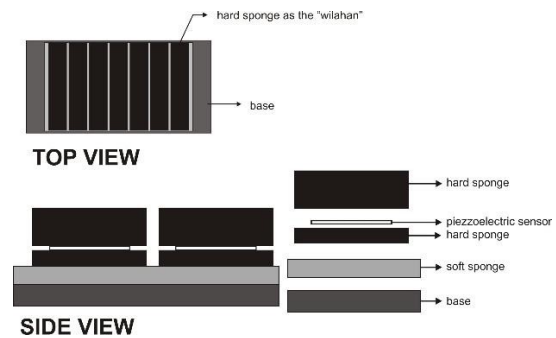

Figure 2. Mechanical Design of Saron Listrik

The plates of the metallophones made of rubber and acrylics. The impact sensor is put in between the rubber and the acrylics. The upper rubber prevents the mallet impact noise due to the difference with the real gamelan where the sound actually produced by the impact itself.



Figure 3. Prototype example of wilahan and pencon style

In Gamelan Listrik, impact of the mallet and the instrument does not generate the gamelan sound directly. Instead, it will generate impact sound without tone or noise that actually we do not want to exist. Therefore, we designed the instrument surface to be soft enough to absorb the impact, but the player still able to feel the impact. Fig. 3 shows example of the gamelan prototype.

### 2.2 Electronic Design

The sound is triggered by the mallet impact to the metallophone plate. The impact is detected using piezoelectric sensor. The sensor converts mechanical force into electric signal. The electric signal is read by the microcontroller through an analog to digital converter (ADC). The signal received by the microcontroller is analog and proportional to the amount of forces generated by the impact. Therefore,

we can use the information to control the volume of the instrument's sound. The tone and the volume information will be sent to the PC as a midi signal. The schematic of the electronic sensor and its signal conditioning design is shown in Fig. 4 below.

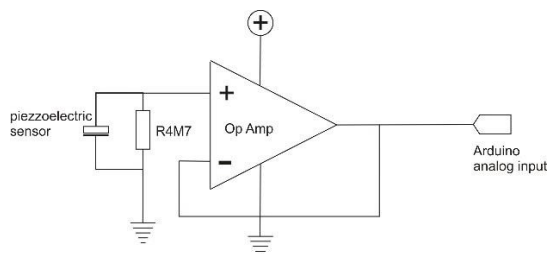

Figure 4. Electronic schematic of the sensor system

### 2.3 Software Design

Gamelan ensemble normally is played in group, and we need a good quality of sound to mimic the real gamelan sound. To manage such things, midi is the best choice since it is the only standard in digital music. The individual instruments of gamelan sound are sampled. The sound was sampled using Kontakt, an industry standard sampler from Native Instrument (Native Instruments, 2019). Kontakt can receive midi signal from several external midi input directly. Using midi hub, we can connect several midi devices that has been programmed to produce different gamelan instrument sound. The block diagram of the midi devices arrangement and the PC is shown in Fig. 5 below

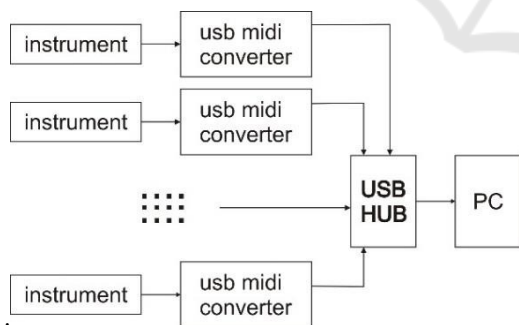

Figure 5. Block diagram of midi devices connection to the PC

## 3 TESTING METHOD

After the system fully assembled, there were several tests conducted to check the performance. We need to know how close the system performance to the real gamelan in term of the player experience and playing sensation. Therefore, some parameters

involved are: latency time, maximum hitting frequency, and the volume or midi velocity range.

Latency time is measured from the first hit of the mallet until the particular sound is produced from the speaker. The struck of the mallet was captured using piezoelectric sensor and then the signal was sent to latency test microcontroller. The output from the speaker was captured using sound sensor and then passed directly to the latency test microcontroller. The detected time difference of the two the signals was measured by the microcontroller and converted into latency time. Maximum hitting frequency test is conducted by measuring and logging the maximum frequency of the mallet strike the metallophone plate whilst it still produces a true and relevant sound. While the midi velocity test was conducted by simply strike the plates in two power variation and plot the response. The hardware connection for the latency test, maximum frequency test, and the midi velocity response test is shown in Fig. 6.

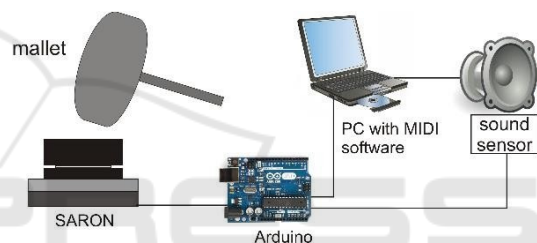

Figure 6. Latency test hardware connection diagram

## 4 RESULT AND DISCUSSION

The three tests result are shown in Table 1 and Fig. 7 to Fig. 8. The latency time result is shown in Table 1. The table shows that in average the system has 14.5 ms latency time including around 1ms the cycle time of the Arduino program as the data acquisition system. Therefore, the overall latency time from the mallet striking to the captured sound from the loud speaker is around 13.5ms. This latency time is acceptable and the actual sound also gives satisfactorily result.

Table 1. Result of the latency test in micro second

No	Latency (uS)	No	Latency (uS)	No	Latency (uS)
1	14904	15	14904	29	14896
2	14240	16	14792	30	14896
3	15008	17	14904	31	14680
4	14784	18	22184	32	12320
5	14896	19	14792	33	15016
6	14792	20	18528	34	15288
7	15008	21	14896	35	14680
8	10216	22	14792	36	16448
9	14896	23	14792	37	14568
10	14896	24	14792	38	14784
11	14904	25	14784	39	10624
12	14784	26	16104	40	14904
13	14784	27	14792	41	14680
14	14896	28	14896	42	14784
Average		14539 uS			

The maximum hitting frequency is shown in Fig. 7. The maximum period of the strike before the actual sound from the speaker overlapped is 149 ms, or the maximum frequency is 6.7 Hz. This frequency is also acceptable because there are no high frequency striking for the basic gamelan training in elementary school.

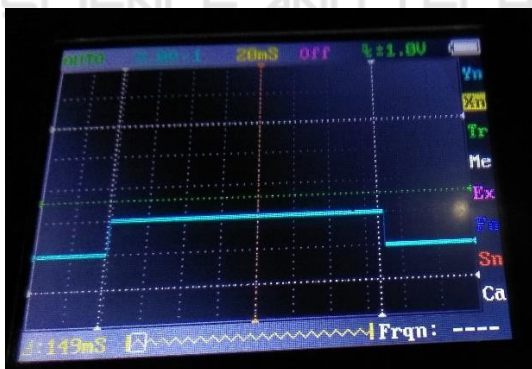

Figure 7. Maximum mallet striking frequency on the metallophone plate

The midi velocity test results are shown in Fig. 8. Higher power strike is shown with higher amplitude and the lower power strike is shown with lower amplitude. From this graph we can set the range of the midi velocity by mapping the actual analog read of the mallet strike to the range of standard midi velocity. This feature is important when we have vocal singing during the play. Normally when the

vocal start, the gamelan player needs to reduce the sound volume by reducing the striking power when playing the gamelan instrument so the vocal can be distinctly heard.

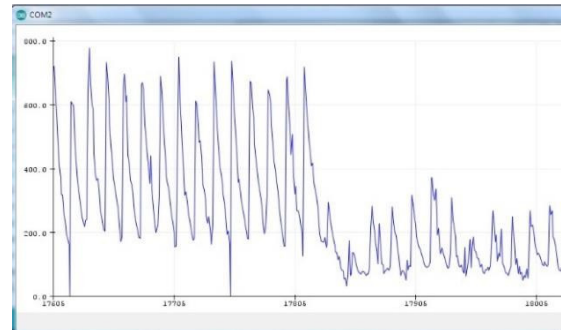

Figure 8. Analog read of the piezo electric sensor for midi velocity test.

The Kontakt software is not a freeware. A sampler or composer software usually is not cheap. However, any school which want to use the Gamelan Listrik can use Kontakt Player software. Kontakt Player software is free. Therefore, we can omit the PC software cost from the overall expenses. The main cost of building this system is for the construction of the gamelan instrument and the embedded controller system as the midi controller. Each instrument has its own mechanical interface and controller. Therefore, if we need ten instruments in our gamelan set, we must make ten set of hardware and ten set of midi controller. Cost to build one set of one instrument hardware interface and one midi controller is around Rp. 400.000,00 including mallet and wiring system. We can arrange one set of gamelan for example consist of: 2 Sarons, 2 Demungs, 1 Peking, 1 Bonang Penerus, 1 Bonang Barung, 1 Slentem, 1 set of Gongs and Kempuls, 1 set Ketuk and Kenong. In total there are 10 instruments, so the total cost is around Rp. 4.000.000,00. We assume that school has their own PC and sound system already, so we exclude it from our cost estimation. According to one source from the Internet (SB Flash Art, 2019), the price of one set fine gamelan made of iron is Rp. 125.845.000,00, made of brass is Rp. 352.195.000,00, and the most expensive made of bronze is Rp. 654.095.000,00.

## 5 CONCLUSIONS

The results showed that the development of the electric gamelan or Gamelan Listrik has been successfully conducted. The instrument input response is quite fast with 13.5 ms latency time. It

means the delay is almost un-noticeable. The maximum input frequency is 6.7 Hz which is also fast enough to handle basic gamelan practice hitting speed. The volume level of the instrument can be controlled by varying the striking force of the mallet. It is easy to add instrument to the ensemble. Just by connecting new instrument through the USB Midi hub and set the midi channel for the new instrument. Playing in solo also possible. The playing command of all instruments in a single song can be pre-programmed into independent microcontroller. Just by managing the midi channel, we can set what instrument should be muted and then we can play to fill the muted channel using the gamelan hardware instrument.

## REFERENCES

- Sumarsam, Introduction to Javanese Gamelan, Notes for Music 451, Wesleyan: Wesleyan University, 1988.
- H. Johnson, "Composing Asia in New Zealand: Gamelan and Creativity," *New Zealand Journal of Asian Studies*, vol. 10, pp. 54-84, 2008.
- P. S. P. Wardhana, I. G. M. Darmawiguna and I. M. G. Sunarya, "Pengembangan Aplikasi Instrumen Gamelan Gong Kebyar Berbasis Android," *Jurnal Nasional Pendidikan Teknik Informatika (JANAPATI)*, vol. 4, no. 2, 2015.
- R. W. Resna, I. Yusniarsih and P. L. Yuliani, "Study On Gamelan Degung As Music Therapy In An Active Labor Phase On The First Stage Of Labor By Using Pain Intensity Rating Scale," *International Journal of Advances in Science Engineering and Technology*, vol. 5, no. 3, 2017.
- S. Ismail, "Music and Music Intervention for Therapeutic Purposes in Patients with Ventilator Support; Gamelan Music Perspective," *Media Nurse Journal of Nursing*, vol. 1, pp. 129-146, 2011.
- M. Mendonça, "Gamelan in Prisons in England and Scotland: Narratives of Transformation and the "Good Vibrations" of Educational Rhetoric," *Ethnomusicology*, pp. 369-394, 2010.
- A. D. Purbayekti, "Proses Pembentukan Citra Modern Gamelan Sebagai produk budaya Melalui Komponen-Komponen dalam Iklan Gamelan United, Thesis," Universitas Atmajaya Yogyakarta, Yogyakarta, 2011.
- A. W. Kurniawan and A. M. Syarif, "Perancangan Aplikasi Pembelajaran Orkestra Gamelan Secara Mandiri Berbasis Computer Assisted Instruction," *Techno.COM*, vol. 12, no. 4, pp. 231-240, 2013.
- Z. Wijaya, "Pengembangan Multimedia Pembelajaran Interaktif Pokok Bahasan "Alat Musik Gamelan" Untuk Pembelajaran Bahasa Jawa Sekolah Dasar Kelas V, Skripsi," Program Studi Teknologi Pendidikan Jurusan Kurikulum Dan Teknologi Pendidikan Fakultas Ilmu Pendidikan, Universitas Negeri Yogyakarta, Yogyakarta, 2015.
- M. B. Hesananta, "Perancangan Alat Musik Virtual Bonang (Gamelan Jawa) Berbasis Android Menggunakan Sensor Ultrasonik Dan Arduino, Skripsi," Program Studi S1 Teknologi Informasi Fakultas Ilmu Komputer Dan Teknologi Informasi Universitas Sumatera Utara, Medan, 2018.
- P. A. Sumirat, "Aplikasi Alat Musik Gamelan Jawa Pada Perangkat Android," *Jurnal Emitor*, vol. 14, no. 1.
- A. O. Wiriadjaja, "Gamelan Sampul: Laptop Sleeve Gamelan," in *13th International Conference on New Interfaces for Musical Expression, NIME'13*, Daejeon, Korea, 2013.
- "Native Instrument website," [Online]. Available: <https://www.native-instruments.com/en/products/komplete/samplers/kontakt-6-player/kontakt-6-player-vs.-kontakt-6/>. [Accessed 3February 2019].
- "SB Flash Art," [Online]. Available: <https://sbflashart.com/blog/tag/jual-gamelan-jawa-komplit-perunggu-super-termurah-di-jawa-timur/>. [Accessed 4 February 2019].