

The Optimized Geometry Solar Chimney as Passive Cooling Solution for Buildings in Jakarta

Dalhar Susanto and M. Aryo Wicaksono

Department of Architecture, Faculty of Engineering, Universitas Indonesia, Kampus UI Street, Kukusan, Depok, Indonesia

Keywords: Geometry solar-chimney, Passive-cooling, Ventilation.

Abstract: Solar chimney uses solar radiation to trigger the buoyancy-driven flow in the building to allow saturated air inside the building to flow out of the building. At this stage, this research aims to find the optimized geometry for the solar chimney that can be used in Jakarta and display the performance of the optimized solar chimney as one of the solutions for passive cooling. In the present paper, the numerical method investigates the airflow, temperature distribution, and thermal comfort inside the empty room without any human and mechanical activity connected with an inclined solar chimney. RNG k-epsilon modeled the steady-state 3D computational fluid dynamics (CFD) to investigate flow inside the chimney. Discrete ordinate (DO) non-grey radiation model with solar ray tracing is used to simulate heat transfer in the chimney from each time in Jakarta. Chimney geometry parameters were monitored from inclination angle, width, air gap, chimney length, airflow, and average outlet velocity. This research's result is that the optimized solar chimney's optimized geometry is suitable for Jakarta climate and the optimized solar chimney's performance as passive cooling in Jakarta.

1 INTRODUCTION

Air conditioning or ventilation purposes use the most energy demand in a building. Space cooling dominates half of the energy demand in commercial buildings, followed by lighting, cooking, and water heating. Nowadays, people tend to use mechanical air conditioning or ventilation to achieve thermal comfort in the building. Mostly, non-renewable energy is used to generate electricity to power this mechanical ventilation.

Solar chimney uses solar radiation to trigger the buoyancy-driven flow in the building to allow saturated air inside the building to flow out of the building. At this stage, this research aims to find the optimized geometry for the solar chimney that can be used in Jakarta and display the performance of the optimized solar chimney as one of the solutions for passive cooling. In the present paper, the numerical method investigates the airflow, temperature distribution, and thermal comfort inside the empty room without any human and mechanical activity connected with an inclined solar chimney. In this research, ANSYS FLUENT 2020 R2 Academic was

employed to develop a three-dimensional numerical model for this research.

2 RESULTS AND DISCUSSION

2.1 Model

The model is based on research that was done by abdeen et al (Abdeen, et al., 2019). A wooden chamber with 3 m x 3 m x 3 m connected to the chimney on the ceiling and the absorber facing the north, opening measured 0,6 m x 0,6 m on the south side of the room. For the simulation's initial stage, the chimney is measured with 1,4 m lengths, inclined to 45°, 0,6 m width, 0,25 m air gap—this model is located in Jakarta with coordinate 6.21462° s, 106.84513° e. The chimney's geometry, such as length, inclination angle, width, and air gap, will be varied at the later stage of this simulation using the design exploration feature in ansys.

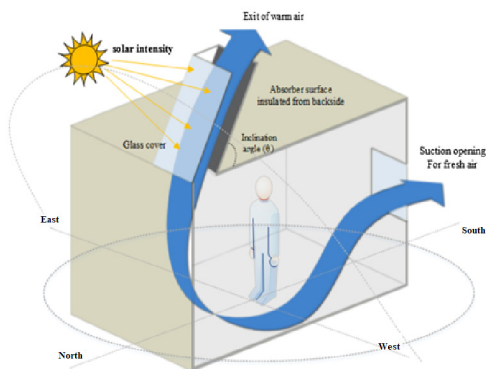

Figure 1. Ventilation flow diagram of the model

The chimney itself is made of 4 mm clear glass on the north, 4 mm opaque glass on the west and east side of the chimney, 1 mm steel sheet on the south side of the chimney act as absorber, and 50 mm insulation glass wool on the backside of the absorber to prevent heat loss from the absorber.

2.2 Mesh

The hexahedral mesh was implemented in this model, with a total of mesh 112.175 elements. If the mesh number is lower than the current total mesh, the simulation will fail in some chimney variation models using the Design Exploration feature. If more extensive, the simulation's runtime will be longer, but the results will be more accurate.

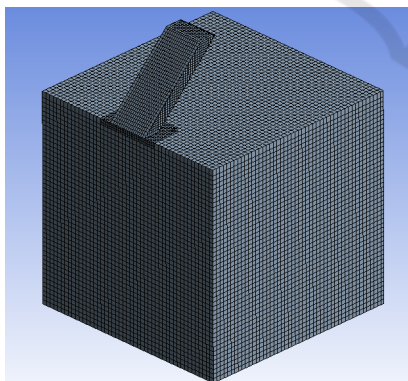

Figure 2. The meshing of the model

2.3 Computational Fluid Dynamics Configuration

Three-dimensional, fully turbulent, and incompressible flow is conducted with ANSYS FLUENT. The energy model is set to activate to simulate the heat transfer of the chimney. The renormalization group (RNG) k-ε model is

implemented to simulate chimney flow. This model is the most accurate in flow separation, streamline curvature, and flow stagnation (Chen, 1995). Gravitation at Y-axis is set to 9,8 m/s². The buoyancy effect is activated. For wall setting, the standard treatment is implemented for this simulation.

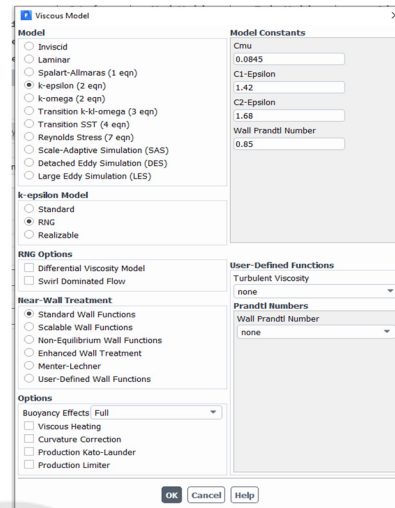

Figure 3. Model setup for flow

The discrete ordinate (DO) model is implemented to simulate the solar load model's radiation to the chimney. The setup for the solar load model in this simulation is placed in Jakarta. The solar load model is set to 11:00 on 1 August because between June to August is when demand for ventilation is high in a year.

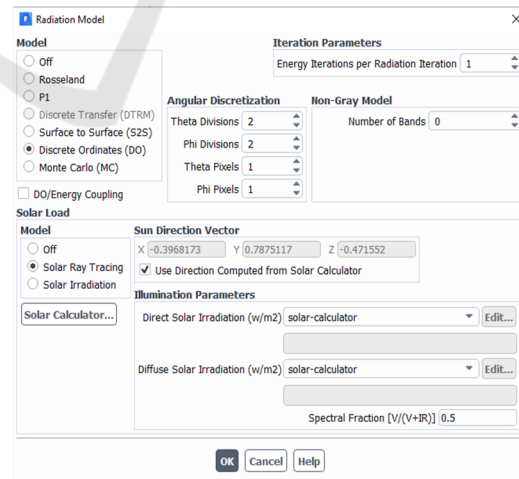

Figure 4. Model setup for radiation

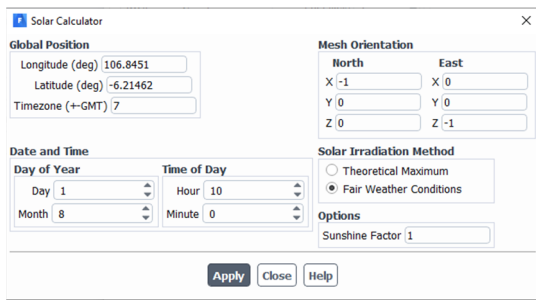

Figure 5. Solar calculator setup

Thermo-physical for fluid properties is assumed to be constant except density. Density is modeled by the Boussinesq approximation, which delivers faster convergence than models that vary density as a function of temperature (ANSYS Fluent. co, 2015). Thermo-physical properties for other materials, such as glass, steel, wood, and insulation, based on Table

Table 1. Material setup for model

Properties	Air	Glass	Steel	Wood	Insulation
Density (kg/m ³)	1,18	2220	8030	700	10
C _p (Specific Heat) (J/(kg K))	1006,43	830	502,48	2310	830
Thermal Conductivity (W/(m K))	0,0242	1,15	16,27	0,173	0,1
Viscosity (kg/(m s))	1,7894*10 ⁻⁵	-	-	-	-
Thermal Expansion Coefficient (1/K)	0,00335	-	-	-	-

The Semi-Implicit Method for Pressure-Linked Equations (SIMPLE) algorithm was applied as pressure-velocity coupling. The least-square cell-based method is applied as a gradient discretization. The staggering pressure option (PRESTO!) method is applied as pressure discretization. The second-order upwind method is applied for momentum, turbulent kinetic energy, turbulent dissipation rate, energy, and discrete ordinates discretization. Absolute convergence is achieved when residuals were less than 10⁻⁴.

For boundary conditions, a no-slip condition is applied for every wall in the model. Mixed thermal conditions were applied for all heated surfaces. The ambient temperature and pressure were assumed to be

35 °C and 1 atm. A pressure inlet with zero-gauge pressure is set as a room inlet with incoming air assumed to be equal to ambient temperature. A pressure outlet with zero-gauge pressure is set to be a room outlet assumed to be equal to the ambient pressure.

2.4 Design Optimization

Chimney geometry, such as length, inclination angle, width, and air gap, will be varied until the outlet achieves optimized airflow and velocity. Using CFD to simulate each variable will be a long process. To shorten the process for each variation and optimize the output, ANSYS 2020 R2 Design Exploration is employed.

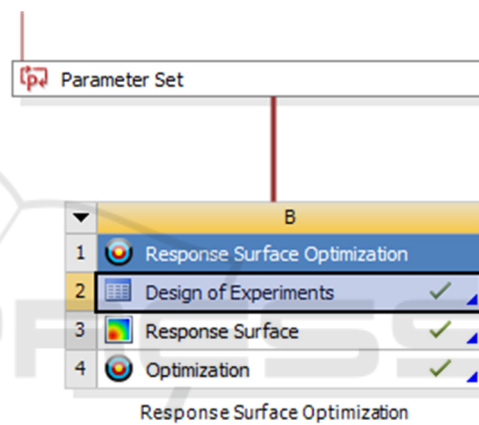

Figure 6. Design Exploration steps in ANSYS

The process for optimization encompasses the initial sampling step through Design of Experiments (DOEs), followed by interpolation technique using Response Surface Method (RSM) and optimization using the Multi-Objective Genetic Algorithm (MOGA).

2.4.1 Design of Experiments (DOEs)

The large number of tests required for one-by-one parameter variation will be time-consuming and not efficient. Although this step is also time-consuming, this process is more efficient than many tests. DOEs is a statistical approach that explores interactions between design and output variables through minimum sampling points, which is set to 25 sampling points in this research. Angle, width, inclination angle, and air gap are stated as input parameters, then airflow and average velocity at the outlet as the output parameter. The optimal Space Filling Design (OSFD) technique is selected because of its ability to provide large amounts of information

with a minimum number of numerical simulations (Abdeen et al., 2019) [1].

Table 2. The minimum and maximum value of each input parameters

Input Parameter	Minimum Value	Maximum Value
Inclination Angle (°)	25	75
Length (m)	1,5	2,5
Width (m)	0,5	3
Air Gap (m)	0,1	0,3

2.4.2 Response Surface Method (RSM)

Response Surface Method (RSM) is a selected approximation function that produces a correlation between input and output parameters used by the fitting algorithm indicated in DOEs methodology. RSM is obtained using a second-order polynomial regression model set and the results generated from DOEs.

2.4.3 Optimization

After RSM is produced, optimization can be performed using MOGA to derive the optimal design based on the targets sets by maximizing the mass flow rate and average air velocity on the outlet. MOGA is an evolutionary algorithm with several objective functions optimized simultaneously and subject to inequality and equality constraints (ANSYS Fluent, co, 2015) [3].

2.5 Simulation Results

The model based on the initial design generates airflow 0,043 m³/s and average velocity on the output 0,405 m/s, as displayed in Figure 7. This simulation shows air on the lower height of the chimney reaches the maximum velocity value, and the velocity was slower near absorber than near glass.

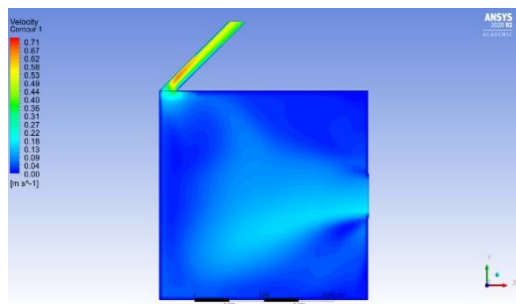

Figure 7. Velocity distribution on initial model design

2.5.1 Design of Experiments Results

DOEs method generates 25 design points and results of the output parameters based on the setup from Table 2. These design points showed in Table 3, and the results were fed to RSM as data for the interpolation approach to produces reasonably accurate predictions.

Table 3. Design points generated from DOEs method

No.	Width (m)	Inclination Angle (°)	Air Gap (m)	Length (m)
1	1,05	44	0,104	1,88
2	2,55	58	0,112	1,92
3	0,85	54	0,224	1,56
4	1,45	72	0,272	1,96
5	1,25	60	0,12	2,32
6	2,65	56	0,152	2,4
7	1,75	66	0,24	2,44
8	2,95	42	0,184	1,72
9	0,65	36	0,176	2,16
10	2,05	46	0,296	2,24
11	2,25	30	0,128	2
12	0,55	64	0,2	2,08
13	1,15	70	0,136	1,76
14	2,45	32	0,264	1,8
15	2,15	74	0,168	2,12
16	0,95	38	0,28	1,84
17	1,65	40	0,16	2,48
18	1,85	48	0,144	1,52
19	1,35	28	0,192	1,68
20	1,95	52	0,288	1,64
21	2,75	34	0,216	2,28
22	2,35	68	0,208	1,6
23	2,85	62	0,248	2,04
24	0,75	50	0,256	2,36
25	1,55	26	0,232	2,2

2.5.2 Response Surface Method Results

From data generated in the DOEs method displayed in Table 3. Each input and output parameter correlation can be explored and displayed in a three-dimensional response chart, as showed in Figure 8.

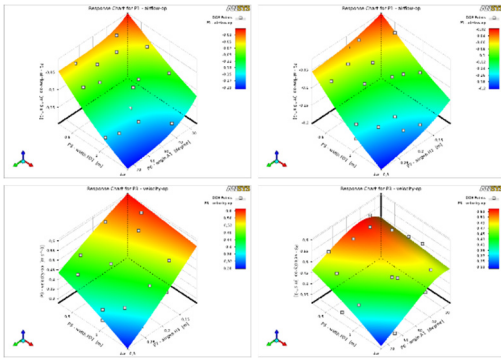

Figure 8. Response charts for airflow and velocity

2.5.3 Optimization Results

Three candidates from the optimization method used MOGA by generating 10.000 designs to explore the optimal solar chimney design by maximizing airflow and average outlet velocity.

Table 4. Optimization candidates

Parameters	Candidate 1	Candidate 2	Candidate 3
Width (m)	2,9986	2,986	2,9988
Inclination Angle (°)	51,901	50,762	49,281
Air Gap (m)	0,10228	0,10064	0,10151
Length (m)	2,4966	2,4975	2,4934
Airflow (m ³ /s)	0,15952	0,15607	0,15488
Average Velocity on The Outlet (m/s)	0,61919	0,62593	0,62823

From the three candidates generated from MOGA, there is a slight difference. Candidate 2 is chosen as the best design because it maximizes airflow and average outlet velocity.

3 CONCLUSIONS

In this research, a three-dimensional steady CFD model was developed. Using the ANSYS® 2020 R2 FLUENT Design Exploration, an optimization technique was used to increase the air velocity and

airflow from buoyancy effects inside the space. This optimization method can integrate various chimney parameters, including the height, width, inclination angle, and air gap between the glass and the absorbing wall. The optimal solar chimney is derived from the optimization method, which features 51° inclination angle, width 2,9988 m, air gap 0,1 m, chimney length 2,5 m. The finding highlights the potential and advantages of employing this 3D optimization technique to enhance natural ventilation solutions for Jakarta buildings by passive solar chimneys.

REFERENCES

- Abdeen, A, Serageldin, A, Ibrahim, M, El-Zafarany, A, Ookawara, S, & Murata, R, (2019), Solar chimney optimization for enhancing thermal comfort in Egypt: An experimental and numerical study, *Solar Energy*, 524-536.
- Chen, Q, (1995), Comparison of different k-ε models for indoor air flow computations, *Numerical Heat Transfer, Part B: Fundamentals*, 353-369.
- ANSYS Fluent, co, (2015), *ANSYS FLUENT Theory Guide [WWW Document]*, Retrieved from <http://www.ansys.com/Products/Fluids/ANSYS-Fluent>.