

Control of Sewer Flow using a Buffer Tank

K. M. Nielsen¹, T. S. Pedersen¹, C. Kallesøe¹, P. Andersen², L. S. Mestre² and P. K. Murigesan²

¹Automation & Control, Department of Electronic Systems, Aalborg University, Aalborg, Denmark

²Control & Automation, Aalborg University, Denmark

Keywords: Sewer Flow Modelling, Model Predictive Control.

Abstract: Flow variations of the inlet to a wastewater treatment plant (WWTP) are problematic due to the biological purification process. A way to reduce variations from industrial areas is to insert a buffer tank. Traditionally the only on-line measurement is the inlet flow to the wastewater treatment plant and reliable measurements in the system are difficult to establish. A control scheme using only one on-line measured variable is shown to be able to give considerable reduction in the flow variations. To implement the control scheme two models are introduced. A linear model (delay model) from the buffer tank to the wastewater treatment plant and an autonomous model describing the daily variations in the household sewer flow. A Model Predictive Controller has been designed and tested in a laboratory set-up with good results.

1 INTRODUCTION

The topic within this paper is flow control for optimization of wastewater treatment systems. The sewer system drains wastewater from industries and private households. A sewer system network consists of gravity pipes, pressurized pipes, pumps, manholes, weirs etc. making up a complex system. In this work, the sewer network in the Danish city Fredericia with approximately 50000 inhabitants is in focus.

The wastewater is comprised of different pollutants like phosphor, nitrogen and biologically degradable components characterized by Chemical Oxygen Demand (COD). The inlet to the WWTP is varying due to daily variations in household wastewater, varying industrial outlets and different time delays from these sources to the WWTP inlet. In addition, precipitation causes irregular variations. In Fredericia in dry periods 60 % to 70 % of the wastewater comes from industries. The sewer system as well as the biological processes are complex and further it is difficult to make on-line measurements of the pollutants. A detailed description of all phenomena is extremely comprehensive as seen in e.g. the simulation tool WATS (T. Hvitved-Jacobsen et al., 2013),(DHI, 2017) and is not well suited for controller design. In this work, only COD is taken into account and furthermore it is assumed that no biological processes takes place in the sewer network. Therefore, a simple model describing the main dynamics is formulated.

In Fredericia the only available real time on-line measurement is the inlet flow to the WWTP. Off-line measurements of COD, nitrate and phosphor are available from October 2017. The average and filtered average of the total flow as well as the COD flow in October 2017 are shown in Fig.1. Flow and COD measurements are sampled from the inlet to the WWTP. As seen in Fig.1 the shape of the COD and flow inlet are similar, therefore only control of the flow to WWTP is investigated in this work. Variation in the COD-flow can be considered in a similar way and will be considered in a continuation of the work.

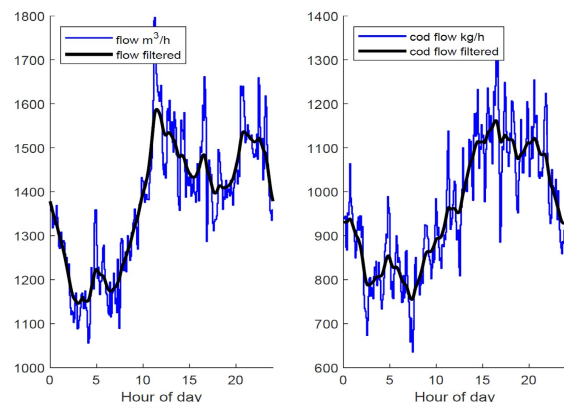

Figure 1: 24 hours average flow and COD based on measurements from 30 days at the inlet to Fredericia WWTP. (Schlutter, 1999). Here, it is assumed there is no infiltration by the groundwater into the sewer system.

A way to minimize the flow variations is to insert buffer tanks in the sewer network and control the outputs from these. At the moment no buffer tanks are available in the sewer system in Fredericia but are to be planned. A logical place for a buffer tank is close to the industrial outlets. An algorithm to control the outflow from the buffer tank in order to minimize flow variations at the inlet to WWTP is developed. Control of sewer systems are described in (Ocampo-Martinez, 2005), (Marinaki and Papageorgiou, 2005), (Overloop, 2006), (Pilgaard and Pedersen, 2018), (Mestre and Murugesan, 2019).

To design a controller, models of the buffer tank, the sewer network, the household flows and industrial flows are necessary.

A simple tank model based on a mass balance is used. A dynamic model describing main characteristics of the sewer network is formulated; here it is shown that the Saint-Venant equations under certain assumptions can lead to a delay model. The model describing the flows from households to the WWTP is an autonomous state space model where the coefficients are based on the Fourier transform of measurements from one month Fig. 1. The outflow from industry is estimated from 24 hours measured time series.

A Model Predictive Controller (MPC) with a performance function aiming to minimize the variance of inlet flow to the WWTP has been formulated given buffer tank volume constraints.

To test the benefit of a buffer tank inserted in the sewer system a laboratory setup (Smart Water Lab) is used.

In section 2 the Fredericia sewer system is described. Section 3 considers the control concept. The sewer system modelling is described in section 4. Section 5 is a description of the actual control of the buffer tank output. The control concept is tested in the laboratory which is described in section 6 and finally the conclusion is in section 7.

2 FREDERICIA SEWER SYSTEM

Fredericia wastewater treatment plant covers the town of Fredericia, nearby villages and industrial areas north and west of the town. The total sewer net is among the largest in Denmark. Households and industrial areas north and west of the town dominate the wastewater in Fredericia. The map shows the northern part of Fredericia divided in subareas. A large number of pipes leads to the WWTP. In this work, the pipes from the industrial areas to the WWTP are considered. These are indicated in the map Fig. 2.

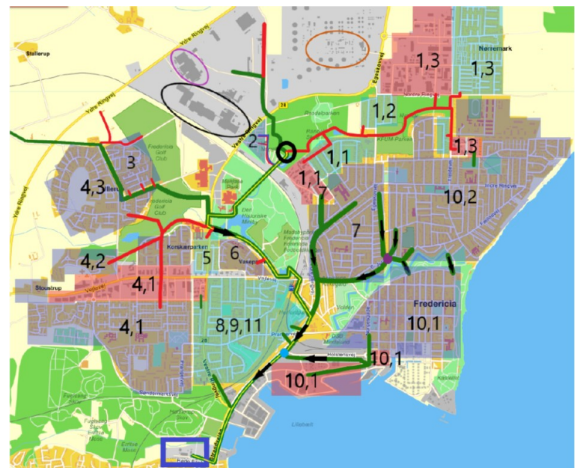

Figure 2: Main sewer system in Fredericia, (Pilgaard and Pedersen, 2018). The blue square is the WWTP, oval shapes are industrial areas, black circle is inlet from industry to the main pipe.

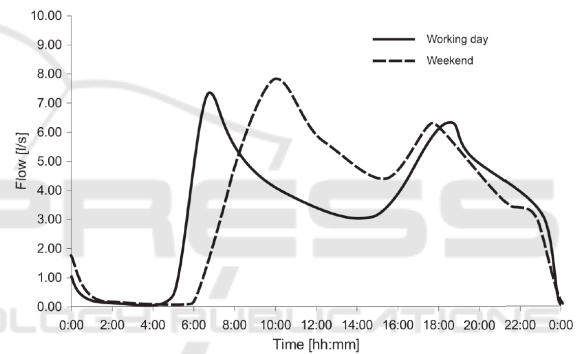

Figure 3: 24 hours average household flow from 2000 inhabitants Wastewater production from a small village Frejlev, Denmark, Here, it is assumed there is no infiltration by the groundwater into the sewer system (Schlutter, 1999).

Household wastewater is predictable with regard to flow. Fig. 3 shows typical average emission from 2000 inhabitants in an area without industries. As seen in Fig. 2, the area covered by the wastewater plant is large and the sewer network is split into numerous branches implying that the shape of the inflow from the households to the wastewater treatment plant is influenced by varying delays in flow.

In the WWPT, the quality of the wastewater treatment and biogas production are dependent on the inflow, as the biological processes need time for scaling. Control of the inlet flow will potentially improve the quality of the WWTP processes. A case study with one industrial plant is investigated; it comprises one buffer tank placed close to the industrial plant, the sewer network from the buffer-tank to the WWTP and one model for the entire household flow to the WWTP.

3 CONTROL CONCEPT

The main goal for the control system is to reduce the fluctuations in the inlet flow, Y , to the WWTP. The assumptions are that the only measurement is Y and the only controllable variable is the outlet flow U from the buffer tank. The inlet flow from industries to the buffer tank is Q_i . Y_{ref} is the WWTP inlet flow reference. In this work, we look at one buffer tank. The concept for controlling this may easily be extended to more detention tanks. In Fig. 4 shows a sketch of the simplified system.

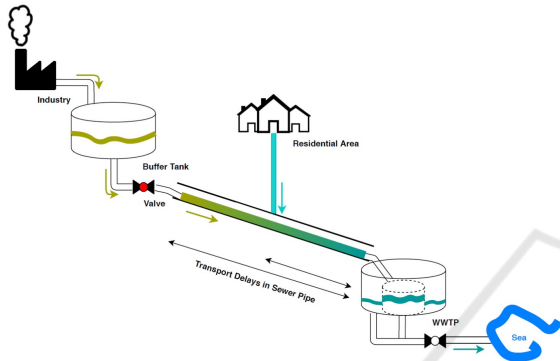

Figure 4: Simplified sewer system with the main components buffer tank, households, sewer pipe and WWTP.

A classical control concept is illustrated in Fig. 5. Q_h is the total household flow disturbance and is seen as a flow directly to the WWTP. The model of the main pipe may include a transport delay; therefore, a classic controller will result in a low bandwidth and poor disturbance rejection (Astrom and Haegglund, 2006), (Postlethwaite and Skogestad, 2005). The disturbance is periodic, see Fig.3, this periodicity is difficult to include in a classic control concept. It is well known from the classical control theory that cascading can improve the performance. More flow measurements in the main pipe will make this possible and up-stream measurements of the household flow could be used as feed forwards. Iterative learning control could be another way to improve a classic controller and a third concept is to use a neural network. Model Predictive Control (MPC) relies on predictions of future system behavior. In this case household wastewater flow shows periodicity and the delay times in the sewer net can be found, therefore the MPC method is chosen.

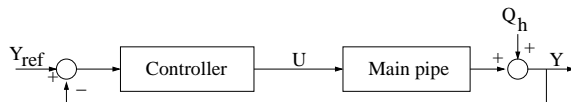

Figure 5: Classical control concept for the problem showing inputs, outputs and disturbances.

4 MODELLING THE SEWER SYSTEM

The model for the MPC consists of a tank model, a model of the sewer network, a household disturbance model and a description of the industrial wastewater flow.

The Tank Model

The tank is modelled as an integrating system

$$\frac{\rho dV(t)}{dt} = \rho Q_i(t) - \rho U(t) \quad (1)$$

Where V is the volume of wastewater in the tank and ρ is the density. It is assumed that ρ is a constant. The discrete version is:

$$V(k+1) = V(k) + T_s(Q_i(k) - U(k)) \quad (2)$$

Where T_s is the sample time.

The Sewer Network Model

The pipes are generally not filled and considered as open channels. The flow and the level in sewer networks are usually modelled by the Saint-Venant equations (Crossley, 1999), (frese.dk, 2018), (Andersen, 1977), (Michelsen, 1976). The general form of the Saint-Venant equations are

$$\frac{\partial A}{\partial t} + \frac{\partial Q}{\partial x} = 0 \quad (3)$$

$$\frac{1}{gA} \frac{\partial Q}{\partial t} + \frac{1}{gA} \frac{\partial}{\partial x} \left(\frac{Q^2}{A} \right) + \frac{\partial h}{\partial x} + S_f - S_b = 0 \quad (4)$$

where Q is the sewage flow [m^3/s], A is the cross-sectional area of the sewage flow [m^2], h is the level in the pipes [m], S_b is the slope and S_f is the friction. x is a spatial variable measured in the direction of the flow [m], t is time [s] and g is gravitational acceleration [m/s^2]. If COD is included in the control a supplementary equation is used to describe this.

These equations are not linear and thereby not well suited for MPC. A simplified linear model is derived.

The transport of fluids could also be seen as a wave propagation. Since there is a net mass transfer involved, the waves are translational. To understand the wave phenomena in gravity and pressure driven fluid mass flows, kinematic wave or dynamic wave analysis is important. When the inertial and pressure forces are minor in the momentum equation (4), kinematic waves govern the flow. Dynamic waves govern

flow when these forces are dominating. In a kinematic wave, the flow does not accelerate considerably as the gravity and friction forces neutralize each other.

Disregarding the first three terms in equation (4), the remaining two terms can be replaced by a flow expression for a fully filled pipe; Mannings equation, (R. Manning and Leveson, 1890) gives a relation between A , h and Q . Since cross sectional area is related to water depth $A = A(h)$ the following relation can be given $Q = Q(h)$.

Using the chain-rule for the continuity equation (3):

$$\frac{\partial A}{\partial h} \frac{\partial h}{\partial t} + \frac{\partial Q}{\partial h} \frac{\partial h}{\partial x} = 0 \quad (5)$$

The two terms $\frac{\partial Q}{\partial h}$ and $\frac{\partial A}{\partial h}$ can be expressed using the Manning equation. These terms are non-linear. Here we use a linearized version of this equation and apply small fluctuations to the flow Q and thereby to the water level h . This leads to the relation

$$c = \frac{\partial Q}{\partial A} = \frac{\frac{\partial Q}{\partial h}}{\frac{\partial A}{\partial h}} \quad (6)$$

and the equation

$$\frac{\partial h}{\partial t} + c \frac{\partial h}{\partial x} = 0 \quad (7)$$

close to the operating point $\frac{\partial Q}{\partial h}$ is constant giving:

$$\frac{\partial Q}{\partial t} + c \frac{\partial Q}{\partial x} = 0 \quad (8)$$

This equation describes waves propagating with unchanged shape and speed c . Changes of flow at the inlet of a pipe will appear at the outlet after a time delay T_d corresponding to the pipe length and propagation speed c . This can be verified by assuming that the flow in position $x = 0$ is $Q(0, t)$ and is known as a function of time t . The flow in an arbitrary position x at time $t - \frac{x}{c}$ is assumed to be

$$Q(x, t) = Q(0, t - \frac{x}{c}) \quad (9)$$

To show that this is a solution to equation 8, the partial derivatives with respect to t and x is

$$\frac{\partial Q}{\partial t} = \frac{\partial Q(0, t - \frac{x}{c})}{\partial(t - \frac{x}{c})} \frac{\partial(t - \frac{x}{c})}{\partial t} = \frac{\partial Q(0, t - \frac{x}{c})}{\partial(t - \frac{x}{c})} \quad (10)$$

$$\frac{\partial Q}{\partial x} = \frac{\partial Q(0, t - \frac{x}{c})}{\partial(t - \frac{x}{c})} \frac{\partial(t - \frac{x}{c})}{\partial x} = \frac{\partial Q(0, t - \frac{x}{c})}{\partial(t - \frac{x}{c})} \left(-\frac{1}{c} \right) \quad (11)$$

inserting these two expressions into equation (8) results in

$$\frac{\partial Q(0, t - \frac{x}{c})}{\partial(t - \frac{x}{c})} + c \frac{\partial Q(0, t - \frac{x}{c})}{\partial(t - \frac{x}{c})} \left(-\frac{1}{c} \right) = 0 \quad (12)$$

which satisfies the equation.

These calculations show that the flows in the sewer network can be modelled as delays under the given assumptions.

The output flow from the buffer tank U is delayed by $\frac{L}{c}$ where L is the length of the pipe from the buffer tank to the WWTP. For control purposes the discretized U can be expressed as $U(k - \tau)$ where τ is the transport delay

The total flow to the WWTP Y is the household flow and the delayed flow from the buffer tank, Y can be described as:

$$Y(k) = Q_h(k) + U(k - \tau) \quad (13)$$

where $Q_h(k)$ is the household flow at time k .

The Household Disturbance Model

The purpose of the model is to estimate the future household flow. Investigations have shown a 24 hours pattern where the flow is low during the night, Fig. 3. A way to find the model of the flow is to use a large number of measurements to find the frequency spectrum. Here the spectrum is found using a DFT and the complex coefficients are used in an autonomous state space model which describes average daily household flow. This model supplemented with a stochastic input will be used in a Kalman observer.

A continuous time sinusoidal in amplitude phase form is described by (Kuo, 1966)

$$y(t) = a_0 + a \cdot \cos(\omega t + \phi) \quad (14)$$

where a_0 is the mean or zero frequency term, a is the amplitude, ω is the frequency and ϕ is the phase difference.

An autonomous state space model (SSM) can be defined

$$\dot{x} = Ax \quad (15)$$

$$y = Cx \quad (16)$$

whose state vector, system matrix, input and output matrix are

$$x(t) = \begin{bmatrix} a_0 \\ a \cdot \cos(\omega t + \phi) \\ a \cdot \sin(\omega t + \phi) \end{bmatrix} \quad (17)$$

and

$$A = \begin{bmatrix} 0 & 0 & 0 \\ 0 & 0 & -\omega \\ 0 & \omega & 0 \end{bmatrix}, C = [1 \quad 1 \quad 0] \quad (18)$$

$y(\omega)$ is the Fourier transform of $y(t)$. The real part and the imaginary part of the Fourier transform coefficients are used in C . The above SSM contains just a single frequency. When there are multiple frequencies, the sinusoidal signal and SSM is:

$$y(t) = a_0 + \sum_{n=1}^N a_n \cdot \cos(n\omega t + \phi_n) \quad (19)$$

$$x(t) = \begin{bmatrix} a_0 \\ a_1 \cdot \cos(\omega_1 t + \phi_1) \\ a_1 \cdot \sin(\omega_1 t + \phi_1) \\ a_2 \cdot \cos(\omega_2 t + \phi_2) \\ a_2 \cdot \sin(\omega_2 t + \phi_2) \\ \vdots \\ \vdots \\ \vdots \\ a_k \cdot \cos(\omega_k t + \phi_k) \\ a_k \cdot \sin(\omega_k t + \phi_k) \end{bmatrix}$$

$$A = \begin{bmatrix} 0 & 0 & 0 & 0 \\ 0 & A_1 & 0 & \dots \\ 0 & 0 & A_2 & \dots \\ \vdots & \vdots & \vdots & A_k \end{bmatrix}$$

where

$$A_i = \begin{bmatrix} 0 & -\omega_i \\ \omega_i & 0 \end{bmatrix} \quad i = 1, 2 \dots k$$

$$C = [1 \quad 1 \quad 0 \quad 1 \quad 0 \quad \dots \quad 1 \quad 0]$$

The discrete-time equivalent of A in (18), with sampling time T_s is

$$\Phi(T_s) = e^{AT_s} \quad (20)$$

This matrix has block diagram structure,

$$\Phi(T_s) = \text{diag}(\Phi_0(T_s), \Phi_1(T_s), \dots, \Phi_k(T_s)) \quad (21)$$

and can be split into

$$\Phi_0(T_s) = 1 \quad (22)$$

$$\Phi_i(T_s) = \begin{bmatrix} \cos(\omega_i T_s) & -\sin(\omega_i T_s) \\ \sin(\omega_i T_s) & \cos(\omega_i T_s) \end{bmatrix} \quad (23)$$

Model for Industrial Waste Water

The industrial wastewater flow Q_i is a significant part of the total inlet to the WWTP. The flow is varying and large COD pulses occur. Q_i is measured several times off-line one day per month.

Information on the industrial wastewater flow is relevant for control purposes. The best-case scenario is exact knowledge of flow and COD from the industrial companies, alternatively a model for typical Q_i variations can be of use. A third method is on-line measurement of the COD and level in the buffer tank inserted close to industry. To prove the concept Q_i is modelled as a constant flow combined with different flow variations.

Model Parameters for Fredericia Sewer System

The sewer network model from the buffer tank to the WWTP is simplified to a time delay. This delay is found using cross correlation of data from one day from the heavy industry and data from the inflow to the WWTP. It turns out that the strongest correlation is at approximately 100 minutes. To find the parameters in the household disturbance model, measurements of 30 days inflow to the WWTP are used. The 30 days measurement has been digital Fourier transformed and the power spectrum is shown in Fig. 6.

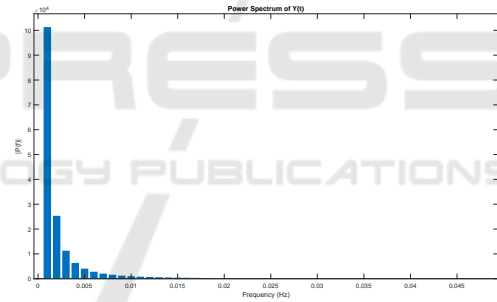

Figure 6: Bar plot of power spectrum which is the square of DFT's magnitude. At low frequencies, the magnitudes are large.

The dominating frequencies are found by using a threshold in the power spectrum. In Fig. 7 frequencies from three different thresholds are simulated.

5 CONTROL OF THE BUFFER TANK OUTPUT

The MPC (Maciejowski, 2002) aims to minimize the variance of the input flow to WWTP. The following performance function is used:

$$J = \sum_{k=1}^{H_p} \left(\hat{Q}_h(k + \tau) + U(k) - \mu \right)_R^2 + \sum_{k=1}^{H_p} \left(\mu \right)_S \quad (24)$$

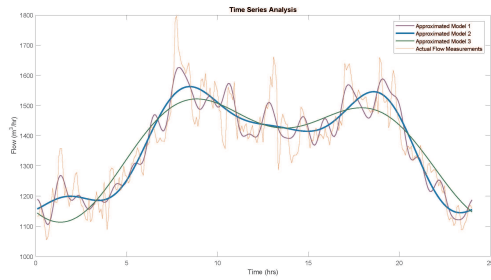

Figure 7: Different model approximations of the original flow data. The thresholds set for the model 1, 2 and 3 are respectively 2500, 900 and 400. The purple curve considered 10 frequencies in the model. The blue curve considered only 5 frequencies in the model. The latter model is used in the subsequent section.

subject to system dynamics and constraints

$$\begin{aligned}
 V(k+i+1) &= V(k+i) + T_s(\hat{Q}_i(k+i) - U(k+i)) \\
 Y(k+i+\tau) &= \hat{Q}_h(k+i+\tau) + U(k+i) \\
 V_{min} &\leq V \leq V_{max} \\
 U_{min} &\leq U \leq U_{max}
 \end{aligned} \tag{25}$$

The first equation is the model of the buffer tank, where \hat{Q}_i is a prediction of the industrial outlet. In the performance function the first term is the variance of the total input to the WWTP, Y . μ is the mean value, H_p is the prediction horizon. \hat{Q}_h is the estimated output of the household flow.

Estimation of \hat{Q}_h is based on a Kalman filter (Kalman, 1960) assuming noise added to the autonomous household flow model.

$$X(k+1) = \Phi X(k) + K(Q_h(k) - CX(k)) \tag{26}$$

where K is the Kalman-gain. The household flow is predicted by

$$\begin{aligned}
 X(i+1) &= \Phi X(i) \\
 \hat{Q}_h(i) &= CX(i)
 \end{aligned} \tag{27}$$

for

$$i = k..(k + H_p + \tau) \tag{28}$$

The Kalman filter approach is tested using measured data from Fredericia. In Fig. 8 the blue curve represents measured data, the red curve is the Kalman estimate. The Kalman filter is updated with measurements at each sample except in the green region. In the green section the Kalman filter estimates without measurements. The results are good within the 24 hours estimate without measurements. The data represents a day without precipitation and the estimate will be uncertain in rainy periods.

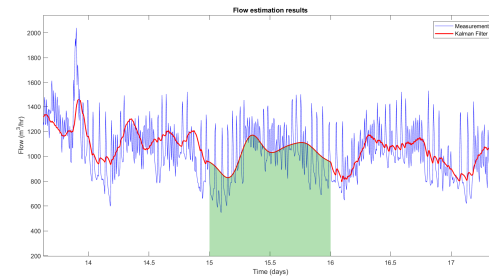

Figure 8: The Kalman filter estimation of \hat{Q}_h for day 15. The process noise and measurement noise in the Kalman filter had a variance of 0.01 and 25 respectively.

6 LABORATORY TEST OF THE CONTROL CONCEPT

A buffer tank and on-line measurements are to be implemented in Fredericia. To prove the concept the control system is tested in Smart Water Lab at Aalborg University seen in Fig.9. Smart Water Lab has components as tanks, pumps, valves, gravity pipes, pressurized pipes etc. The modules of the Smart Water Lab are configured to emulate the simplified system as in Fig. 10. The consumer station is a buffer tank from which appropriate household flow is emulated. The blue arrows are pipes in the sewer system and the sewer station is the WWTP. The purpose of the pumping station is twofold, firstly it generates a disturbance flow to the inlet of the Sewer Station emulating the household flow and secondly it re-circulates water to the consumer tank (yellow arrow).



Figure 9: Smart Water Lab at Aalborg University.

Deterministic (white-box) models are developed to describe the dynamics of some key components of the sewer network.

The laboratory set-up simulates the delay in the gravity pipe and it is possible to introduce a disturbance illustrating the periodic household flow. The disturbance can be seen as the yellow curve in Fig. 11. The flow from industry is implemented as a con-

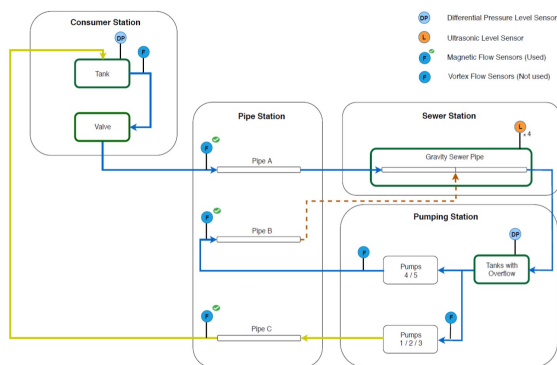

Figure 10: Circuit for the test set-up in Smart Water Lab containing a consumer station, a pipe station, a sewer station and a pumping station.

stant flow to the buffer tank. An MPC minimizing the performance function equation 24 is implemented in the laboratory by use of YALMIP (M.C. Grant and Stephen, 2014), (Lofberg, 2014). It aims to minimize the variations of the inlet flow to the sewer station. The result can be seen in Fig. 11. The measurement of the controlled flow (blue) has poor resolution, a filtered version is the red curve. It is seen that the controlled inlet flow has a lower variance than the original uncontrolled flow (yellow).

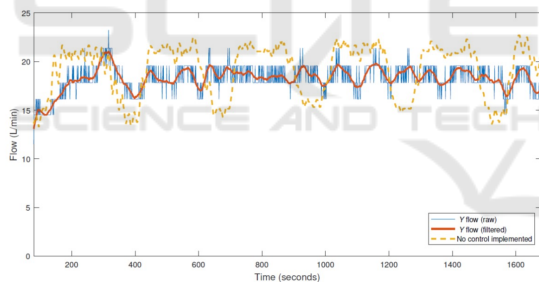

Figure 11: Comparison of uncontrolled (yellow) and controlled (blue and red) inlet to the sewer station.

The laboratory test shows that a buffer tank in combination with an MPC algorithm can reduce the variations in the inlet flow to the WWTP.

7 CONCLUSION

Typical inlet to a WWTP consists of periodic household flow and industrial flow. A control system for minimization of flow variations to a WWTP using a buffer tank for the industrial flow has been constructed. The controller is based on two models, one model describing the flow variations from the buffer tank to the WWTP and one describing the household flow. The flow from the buffer tank to the WWTP is

described by the Saint-Venant equations. Under linear assumptions it is shown that the flow model results in a time delay. The model for the household flow uses an autonomous description. The two models are inserted in a MPC with a performance that minimize the flow variations. A lab set-up shows that the control concept is able to minimize the variance of the mentioned flow.

REFERENCES

- Astrom, K. J. and Haeggglund, T. (2006). *Advanced PID control*. ISA.
- Andersen, P. (1977). *Optimering af driftsbetingelser for spildevandsanlæg gennem automatisering*. Aalborg University, Denmark.
- Crossley, A. J. (1999). *C, Accurate and efficient numerical solutions for the Saint Venant equations of open channel flow*. University of Nottingham.
- DHI (2017). Wats-wastewater aeroc/anaerobic transformation in sewers, mike eco lab template. In *Scientific Description*. MIKE.
- frse.dk (2018). <https://www.frse.dk/Fredericia-spildevand.aspx>. urldate: 2018-10-03.
- Kalman, R. E. (1960). *A new approach to linear filtering and prediction problems*, *Journal of basic Engineering vol2, nr1, p 35-45*. American Society of Mechanical Engineers.
- Kuo, F. F. (1966). *Network analysis and synthesis*. John Wiley and Sons.
- Lofberg, J. (2014). *A toolbox for modeling and optimization in MATLAB*. CACSD Conference, vol.3, Taipei, Taiwan.
- Maciejowski, J. M. (2002). *Predictive control: with constraints*. Pearson education.
- Marinaki, M. and Papageorgiou, M. (2005). *Optimal real-time control of sewer networks*. Springer Science & Business Media.
- M.C. Grant, S. B. and Stephen, P. (2014). *The CVX Users Guide, Release 2.1*. URL <http://cvxr.com/cvx/doc/CVX>.
- Mestre, L. S. and Murugesan, P. K. (2019). *Laboratory Emulation and Control of a Sewer System with Storage*, *Master Thesis, Control and Automation, Aalborg University*. Aalborg University, Denmark.
- Michelsen, H. (1976). *Ikke-stationær strømning i delvis fyldte kloakledninger: en dimensioneringsmetode og en analysemetode*. Afdelingen for Jord- og Vandbygning, Den kgl. Veterinaer-og Landbohøjskole, Denmark.
- Ocampo-Martinez, C. (2005). *Model predictive control of wastewater systems*. Springer Science & Business Media, 2.
- Overloop, P. J. V. (2006). *Model predictive control on open water systems*. IOS Press.
- Pilgaard, T. H. and Pedersen, J. N. (2018). *Model Predictive Control of a Sewer System*, *Master Thesis, Control*

- and Automation, Aalborg University. Aalborg University, Denmark.*
- Postlethwaite, I. and Skogestad, S. (2005). *Multivariable Feedback Control- Analysis and Design*. Wiley and Sons Ltd.
- R. Manning, J. P. Griffith, T. P. V.-H. and Leveson, F. (1890). *On the flow of water in open channels and pipes*.
- Schlutter, F. (1999). *Numerical modelling of sediment transport in combined sewer systems, The Hydraulics and Coastal Engineering Group, Dept. of Civil Engineering*. Aalborg University.
- T. Hvitved-Jacobsen, J. Vollertsen, and A. H. Nielsen (2013). *Sewer processes: microbial and chemical process engineering of sewer networks*. TCRC press.

