

Malware Classification using Long Short-term Memory Models

Dennis Dang^a, Fabio Di Troia^b and Mark Stamp^c

Department of Computer Science, San Jose State University, San Jose, California, U.S.A.

Keywords: Malware, Machine Learning, Deep Learning, LSTM, biLSTM, CNN.

Abstract: Signature and anomaly based techniques are the quintessential approaches to malware detection. However, these techniques have become increasingly ineffective as malware has become more sophisticated and complex. Researchers have therefore turned to deep learning to construct better performing model. In this paper, we create four different long-short term memory (LSTM) based models and train each to classify malware samples from 20 families. Our features consist of opcodes extracted from malware executables. We employ techniques used in natural language processing (NLP), including word embedding and bidirection LSTMs (biLSTM), and we also use convolutional neural networks (CNN). We find that a model consisting of word embedding, biLSTMs, and CNN layers performs best in our malware classification experiments.

1 INTRODUCTION

1.1 Overview

Malicious software (malware) are computer programs that are created to harm a computer, computer systems or a computer user (Tahir, 2018). Malware attacks can disrupt a person's or organization's day-to-day use of their computer systems, steal personal or confidential information, corrupt files or annoy users. Malware can be categorized into different families where the behavior of malware from one particular family differs from that of another family. The papers (Choudhary and Sharma, 2020) and (Prajapati and Stamp, 2021), for example, discuss the behavior of many different malware families.

Modern malware attacks are generally facilitated by the Internet. With the rise in the number of devices that are connected to the Internet, it has become more important than ever to keep our devices safe, lest we risk loss of personal or confidential information (Choudhary and Sharma, 2020). While many malware attacks are often annoying, some can be life threatening. An example of the latter occurred In 2017 when a ransomware¹ attack crippled

parts the United Kingdom's National Health Service (NHS) (Williams, 2018). Computer systems containing data pertaining to the health of thousands of patients were targeted across dozens of hospitals in the UK. Hospitals were forced to pay a ransom to have their files unlocked or risk having their files corrupted or deleted. These attacks caused doctors and nurses to cancel some 19,000 appointments, and they cost the NHS £92 million. Malware is clearly a security challenge that warrants a significant research effort.

Malware detection techniques include signature based detection, anomaly based detection, and machine learning based detection (Tahir, 2018). Signature based detection has long been the most popular approach to detecting malware. In a signature based approach, each malware sample is first analyzed and a signature is extracted, which is then used to identify the malware. A signature is typically a carefully chosen, fixed bit string that is extracted from a malware sample. If the signature is found in another sample, that sample is flagged as possible malware. However, various code obfuscation and code morphing techniques can easily thwart signature based detection mechanisms.

An anomaly based detection system looks for activity that falls outside the "normal" range of a computer (Mujumdar et al., 2013), and such behavior is flagged as suspicious. Anomaly based systems often suffer from a high false positive rate. The drawbacks of signature and anomaly based detection has motivated the rise of machine learning techniques.

^a <https://orcid.org/0000-0001-6842-2910>

^b <https://orcid.org/0000-0003-2355-7146>

^c <https://orcid.org/0000-0002-3803-8368>

¹Ransomware is a type of malware that threatens to corrupt, delete, publish or block the victim's data unless a ransom is paid.

Many classical machine learning algorithms have found success in detecting malware (Sewak et al., 2018). These algorithms include support vector machines (SVM), hidden markov models (HMM), random forest, and naive Bayes, among many others. Such models rely heavily on proper feature extraction from the dataset. Deep learning techniques have also gained considerable traction—multilayer perceptrons (MLP), convolutional neural networks (CNN), and extreme learning machines (ELM) have all been used with success (Jain et al., 2020). Other techniques involving variants of recurrent neural networks (RNN), such as gated recurrent units (GRU) and long-short term memory (LSTM) models have received far less attention in the literature (Lu, 2019).

In this research, we focus on using LSTMs to classify malware by family. We build on the work in (Lu, 2019) by combining various aspects of the methodologies employed in (Athiwaratkun and Stokes, 2017), (Zhang, 2020), and (Mishra et al., 2019). Our dataset includes malware belonging to 20 distinct families, and we use opcode sequences as our features. We consider five models, with each model being successively more complex. Our first model is the most basic consisting of only MLPs. This model serves as a baseline from which we compare our other LSTM models to. Our second model consists of only one LSTM layer. Our third model is an enhanced LSTM that includes an embedding layer, similar to the model considered in (Lu, 2019). Our fourth model replaces the LSTM layer from our second previous model with a biLSTM layer. Finally, our fifth model includes everything from our third model, plus an additional one-dimension CNN layer and a one-dimension max pooling layer. As far as we are aware, our fourth and fifth models have not previously been considered in the literature.

The remainder of this paper is organized as follows. Section 2 discusses relevant previous work and introduces the various deep learning techniques employed in this research. Section 3 covers the dataset, feature extraction, parameters, and so on. In Section 4, we present our experimental results. Finally, Section 5 concludes the paper, and we mention possible directions for future work.

2 BACKGROUND

2.1 Related Work

The authors of (Athiwaratkun and Stokes, 2017) consider various models for malware classification. In

one of these models, a two stage classifier is used—the first stage is either an LSTM or GRU which is used to derive features for a second stage classifier consisting of a single MLP layer. Another model uses a single stage classifier consisting of nine CNN layers. When trained and evaluated, both models achieved an about 80% accuracy.

In (Zhang, 2020), the author proposes a novel deep learning architecture that includes both a CNN layer and an LSTM layer. This model is trained on API call sequences. The CNN portion of the model consists of filters of increasing size, with the output of each filter fed into the LSTM layer. The output of the LSTM layer is used as input to a dropout layer, with a final fully connected layer for classification. The output of the dense layer is the model’s prediction for the given input. This model achieved an accuracy approaching 100%.

The authors of (Mishra et al., 2019) consider a biLSTM based model to classify malware in a cloud-based system. The model includes a CNN layer and is trained on system call sequences. The authors achieve an overall accuracy of approximately 90%. Interestingly, the authors also show that substituting the biLSTM for a regular LSTM layer resulted in worse accuracies in almost all cases.

The author in (Lu, 2019) classifies malware using an entirely different approach from the two papers mentioned above. The work in (Lu, 2019) is based on opcodes obtained from disassembled executables. This research also employs word embedding as a feature engineering step. Word embedding techniques are often used in natural language processing (NLP) applications. The result from word embedding are fed into an LSTM layer. For malware detection, this model attains an average AUC of 0.99, while for classification, the model achieves an average AUC of 0.987.

2.2 Recurrent Neural Networks

In feedforward neural networks, all training samples are treated independently of each other (Stamp, 2017). Consequently, feedforward networks are impractical for cases where training samples depend on previous samples. Thus, a different type of architecture is needed in cases where “memory” is required, as when training on time series or other sequential data.

Recurrent neural networks (RNN) serve to add memory to the network (Mikolov et al., 2011). As illustrated in Figure 1 (a), the output in a RNN depends not only on the current input, but also the input from the past, as indicated by a feedback

loop. Whereas information only flows forward in a feed-forward network, information from the previous timesteps are available at each subsequent timestep in RNNs (Chowdhury and kashem, 2008). An unrolled view of an RNN (Britz, 2015) appears in Figure 1 (b).

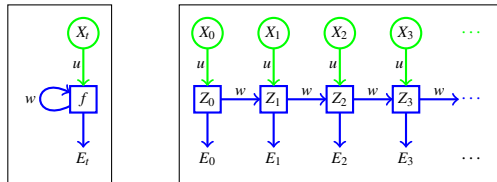

(a) Simple RNN (b) Simple RNN unrolled

Figure 1: Simple RNN and its unrolled version.

2.3 Long Short-term Memory

While conceptually simple, plain vanilla RNNs suffer from the “vanishing gradient” issue when training via backpropagation, which severely limits the “memory” available to the model. To overcome this gradient issue, complex gated RNN architectures have been developed—the best known and most widely used of these is long short-term memory (LSTM) models. LSTMs address the issue of long-term dependency by, in effect, decoupling the memory from the output of the network and ensuring that additive updates are done to the memory, rather than multiplicative updates. With additive updates, the gradient is more stable.

One timestep of an LSTM is illustrated in Figure 2. The cell state c_t serves as a repository for long term memory that can be tapped when needed. The “gate” represented by W_f enables the model to “forget” information in the cell state, W_i and W_g together serve to add “memory” to the cell state, and the structure involving the output gate W_o allows the model to draw on the stored memory in the cell state.

A detailed discussion of LSTMs is beyond the scope of this paper. For more information on LSTMs, see (Cheng et al., 2016), for example.

2.4 Bidirectional LSTM

BiLSTM models are an extension of LSTMs that process a sequence of data in both forward and backward directions in two separate LSTM layers. The forward layer processes the data in the same way as a standard LSTM, while the backward layer processes the same data but in reverse order (Tavakoli, 2019). As with LSTMs, a detailed discussion of biLSTMs is beyond the scope of this paper—see, for example, (Cui et al., 2018) for more details.

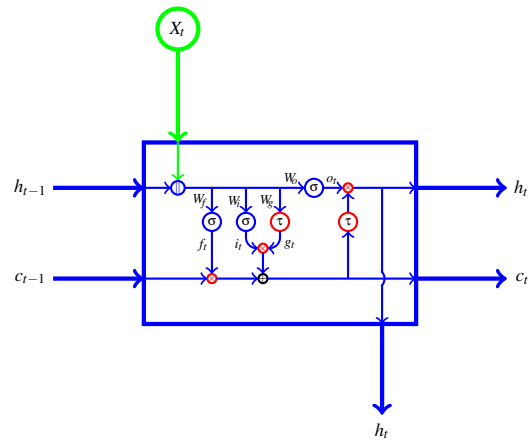

Figure 2: One timestep of an LSTM.

2.5 Word2Vec

Word2Vec is a technique for embedding “words” into a high-dimensional space. These word embeddings are obtained by training a shallow neural network. After the training process, words that are more similar in context will tend to be closer together in the Word2Vec space.

Perhaps surprisingly, meaningful algebraic properties also hold for Word2Vec embeddings. For example, according to (Mikolov et al., 2013), if we let $w_0 = \text{“king”}$, $w_1 = \text{“man”}$, $w_2 = \text{“woman”}$, $w_3 = \text{“queen”}$ and $V(w_i)$ is the Word2Vec embedding of word w_i , then $V(w_3)$ is the vector that is closest—in terms of cosine similarity—to

$$V(w_0) - V(w_1) + V(w_2)$$

Results such as this indicate that Word2Vec embeddings of English text capture significant aspects of the semantics of the language.

In the context of this paper, the “words” are mnemonic opcodes. We use Word2Vec embeddings as form of feature engineering, with the Word2Vec vectors serving as input features to our models. Previous research has shown that Word2Vec features are more informative than raw opcode features (Chandak et al., 2021).

2.6 Convolutional Neural Networks

Convolutional neural networks (CNNs) are designed primarily to efficiently deal with local structure (Stamp, 2019). CNNs were originally designed for use in image classification, but the technique is applicable in any situation where some form of local structure dominates.

The hidden layers within a CNN act as filters where each filter specializes in detecting a certain feature within the data, while deeper layers detect progressively more abstract features. For example, when training on images, first layer filters might detect vertical and horizontal lines, the final layer might be able to distinguish between images of, say, dogs and cats.

While not strictly required, pooling layers can be applied in between CNN layers. These layers reduce the dimensionality, thereby reducing the computational load. Pooling can also reduce noise and potentially improve performance. In max pooling, we specify a window size and only the maximum value within each (non-overlapping) window is retained.

2.7 TensorFlow Layers

TensorFlow models are created by adding various layers in sequence. What distinguishes one model from another is the type of layers used and the parameters passed into the constructors of each layer. A short description of each layer is provided below (TensorFlow Core v.2.3.0 API, 2020).

- **Input Layer:** The first layer and entry point into a neural network
- **Dropout Layer:** Adds noise to the network during training by randomly severing the number of connections between neurons from one layer to the next. In doing so, overfitting is reduced allowing models to better generalize. This typically has the effect of increasing model accuracy during evaluation.
- **LSTM Layer:** Implements a single LSTM layer with all of the algorithms required for forward and backward propagation.
- **Bidirectional Layer:** A wrapper layer that allows RNN layers to implement bidirectional models. Rather than implementing two separate RNN layers for the forwards and backwards direction and concatenating the results, the bidirectional wrapper layer does all of this in one layer.
- **Dense Layer:** Implements a single fully connected vanilla neural network layer.
- **Embedding Layer:** Responsible for mapping positive integers to vectors of floating point values.
- **Conv1D Layer:** Implements the convolutional neural network layer in one dimension.
- **MaxPooling1D Layer:** Implements the max pooling operation in one dimension.

3 DATASET AND EXPERIMENTAL DESIGN

The dataset used in this research was acquired from (Prajapati and Stamp, 2021) and from (Nappa et al., 2015). Our dataset consists of binary files from 20 distinct malware families. The names of the malware families and the number of samples per family is shown in Table 1.

To extract features from our dataset, we first disassemble every executable file and extracted mnemonic opcode sequences. Afterwards, we perform a frequency analysis on all opcodes. The results from this frequency analysis is used to sort opcodes in order of decreasing frequency. Next, we create an opcode to integer mapping where each opcode is assigned a unique integer. Finally, we use this mapping to convert each opcode mnemonic into integers.

We retain the 30 most frequent opcodes, with all remaining opcodes grouped into a single “other” category. Each omitted opcode contributes less than 0.5% to the total number of opcodes and hence would have minimal effect on sequence-based techniques. Note that this approach has been used many recent studies, including (Chandak et al., 2021; Jain et al., 2020; Prajapati and Stamp, 2021).

Table 1: Number of samples per malware family.

Malware Family	Samples
Adload	1044
Agent	817
Alureon	1327
BHO	1159
CeeInject	886
Cycbot	1029
DelfInject	1097
Fakerean	1063
Hotbar	1476
Lolyda	915
Obfuscator	1331
Onlinegames	1284
Rbot	817
Renos	1309
Starpage	1084
Vobfus	924
Vundo	1784
Winwebsec	3651
Zbot	1785
Zeroaccess	1119
Total	25,901

The models used in this research require all input data to be of the same length. To accomplish this, we experimented with various opcode sequence lengths, as discussed below. Of course, truncating the opcode sequence results in a loss of information, but using a short sequence improves efficiency. Our results show that we can obtain strong results with relatively short

opcode sequences.

3.1 Hardware and Software

The models used in this research were run on a PC desktop. The specifications of this machine is shown in Table 2. In addition, the software, operating system, and Python packages used are specified in Table 3.

Table 2: Relevant hardware specifications.

Hardware	Feature	Details
CPU	Brand and Model	Intel i7-8700
	Base Clock Speed	3.2 GHz
	# Core	6
	# Threads	12
GPU	Chipset	NVIDIA GeForce GTX 1070 Ti
	Video Memory	8GB GDDR5
	Memory Speed	1683 MHz
	Cuda Cores	2432
DRAM	Brand and Model	G. Skill TridentZ RGB Series
	Amount	2 × 8GB = 16GB
	Speed	3200MHz
Motherboard	Brand and Model	MSI Z370 SLI Plus LGA 1151

Table 3: Relevant software, operating system, and Python packages.

Software	Version
OS	Windows 10 Pro
Python	3.8.3
Jupyter Notebook	6.1.4
Numpy	1.18.5
Scikit Learn	0.23.2
Tensorflow-GPU	2.3.1
CUDA Toolkit	10.1
cuDNN SDK	7.6
Nvidia GPU Drivers	431.36
Oracle VM VirtualBox	6.0.10
VM OS	Ubuntu 18.04.5 LTS

3.2 Model Parameters

Deep learning models generally have many parameters that require tuning. For each of our models, we performed a grid search over reasonable values for a wide range of parameters—all combinations of the values tested are listed in Table 4. All models were trained and evaluated on the same dataset. For every model evaluated, the accuracy was determined and the parameters for the model with highest accuracy were generally selected. In a few cases where accuracy differences were deemed insignificant, we selected parameters so that training times were reduced. In Table 5, we list the specific values of the parameters that were selected. These parameter were used for

all subsequent experiments considered in this paper.

Table 4: Parameters tested.

Parameter	Values Tested
Opcode Lengths	[2000, 4000, 6000, 8000, 10000]
LSTM Units	[16, 32, 64, 128, 256]
Embedding Vector Lengths	[16, 32, 64, 128, 256]
Dropout Amount	[0.1, 0.2, 0.3, 0.4]

Table 5: Parameters selected.

Parameter	Value
Batch Size	32
Maximum Number of Epochs	100
Percentage of Data to be Used in Testing	15%
Number of Unique Opcodes Used	30
Opcode Sequence Length	2000
Dropout Amount	30%
Number of LSTM Units	16
Embedding Vector Length	128
CNN Kernal Size	3
Number of CNN Filters	128
Max Pooling Size	2

3.3 Training and Testing

The dataset was sorted in ascending order based on the number of training samples per family. The dataset was then partitioned into four groups of five families each, where the first group consisted of families with the most malware samples, while the last group consisted of families with the least samples. The models were trained on the first group of 5 families, then the second group of 10 (i.e., the first and second groups of 5), then the third group of 15, and finally on all families together. With each additional group, the difficulty of classifying malware by family increased—not only due to the inherent difficulty of having more classes, but also due to more limited training data for some of the families. Table 6 lists the families that constitute each group, while Table 7 gives the number of training and testing samples for each group considered.

The initial values of the weights of the LSTM are randomly selected and the embedding and dense layers are randomly initialized each time the models are trained. As a result of this random initialization, the model will likely differ, and hence the accuracy will also likely vary each time a model is trained. Therefore, we train each model type on each grouping of malware families five times. At the start of every

Table 6: Groupings of families.

Group	Malware Families
1	Hotbar Renos Vundo Winwebsec Zbot
2	Alureon Bho Obfuscator Onlinegames Zeroaccess
3	Adload Cycbot Delfinject Fakerean Startpage
4	Agent Ceeinject Lolyda Rbot Vobfus

Table 7: Number of samples for training and testing.

Groups	Families	Samples	
		Training	Testing
1	5	8480	1472
1,2	10	13,760	2400
1,2,3	15	18,272	3200
1,2,3,4	20	21,984	3872

training run, the dataset is shuffled before being split into training and testing sets. The average of these five cases is used to compare the different model types.

4 EXPERIMENTS AND RESULTS

In this section, we give experimental results for each of the four model types tested. We conclude this section with a comparison of the different models.

4.1 Using MLP Only

The structural layout of our first model using only MLPs is given in Figure 3. Note that in this model, no LSTMs were used. The MLP layers are represented by dense layers. The first dense layer learns the features of each input while the second dense layer is the classifier. The experimental results for this model appear in Table 8. For five families, this model performs reasonably well with average accuracy of 83.56%. However, the accuracy drops significantly when more families are added.

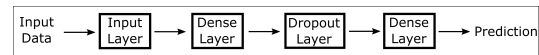

Figure 3: Structure of model using MLP only.

Table 8: Results for the MLP model.

Number of Unique Families to Classify	Accuracy Per Experiment (%)	Average Accuracy (%)
5	81.95	83.56
	84.08	
	82.41	
	85.14	
	84.21	
10	56.31	57.50
	56.81	
	59.40	
	61.50	
	53.48	
15	49.27	51.22
	53.18	
	54.82	
	54.54	
	44.31	
20	53.83	50.48
	45.68	
	52.92	
	46.87	
	53.08	

4.2 LSTM without Embedding

The structural layout of our basic LSTM model given in Figure 4. Note that the model consists of four types layers, namely, an input layer, dropout layers, an LSTM layer, and a dense layer. The experimental results for this model appear in Table 9. This model struggles with classifying just five families, with an average accuracy of 55.73%. The accuracy drops as more families are classified. Clearly, a more sophisticated model is required.

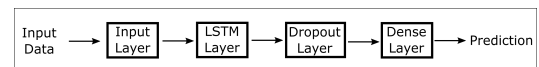

Figure 4: Structure of LSTM model without embedding.

4.3 LSTM with Embedding

In this model, we add an embedding layer to our basic LSTM, as illustrated in Figure 5. Note that the embedding layer is between the input and LSTM layer. The experimental results for this model are in Table 10. We see a significant improvement in the accuracy, with an average result of 74.66% with 5 families, but the accuracy drops dramatically when 10 or more families are considered.

Table 9: Results for LSTM without embedding.

Number of Unique Families to Classify	Accuracy Per Experiment (%)	Average Accuracy (%)
5	63.91	55.73
	48.44	
	63.65	
	42.94	
	60.73	
10	40.50	39.28
	36.96	
	41.46	
	43.75	
	33.71	
15	32.65	34.47
	35.56	
	32.34	
	35.06	
	36.46	
20	34.25	30.55
	27.74	
	30.42	
	30.45	
	29.88	

Table 10: Results for LSTM with embedding.

Number of Unique Families to Classify	Accuracy Per Experiment (%)	Average Accuracy (%)
5	76.09	74.66
	73.64	
	73.17	
	76.90	
	73.51	
10	54.46	54.89
	56.96	
	55.67	
	54.71	
	52.90	
15	54.28	53.36
	51.97	
	50.28	
	53.22	
	57.03	
20	51.11	49.66
	52.12	
	51.60	
	45.82	
	47.65	

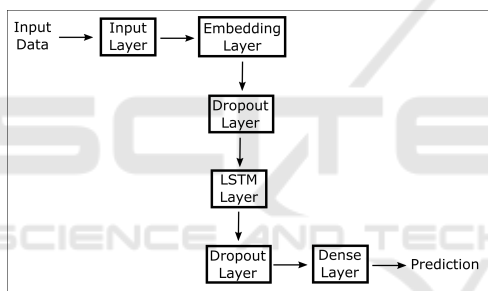

Figure 5: Structure of LSTM with embedding.

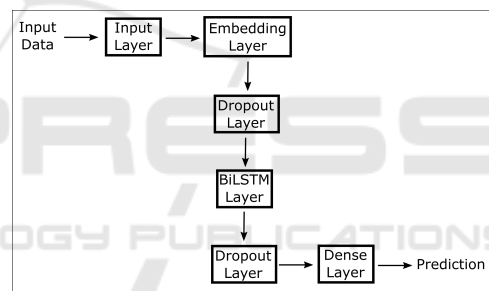

Figure 6: Structure of BiLSTM with embedding.

4.4 BiLSTM with Embedding

The structural layout of our first BiLSTM model is shown in Figure 6. The only difference from our previous model is that the uni-directional LSTM layer has been replaced with a BiLSTM layer. The experimental results for this model are given in Table 10. From the results, we can see that a BiLSTM is far more powerful than an LSTM in this context, as the accuracy has improved significantly. In fact, the accuracy when classifying 20 families with this BiLSTM model is nearly as good as the 5-family accuracy for the previous model.

4.5 BiLSTM with Embedding and CNN

The structure of this model appears in Figure 7. Note that this model includes all of the layers as the previous model with the addition of a one-dimension convolutional layer and a max pooling layer.

The experimental results for this case are given in Table 12. The addition of these CNN layers improves accuracy, and the improvement is most significant as more families are considered—even for 20 families, we obtained a very respectable 81.06% average accuracy.

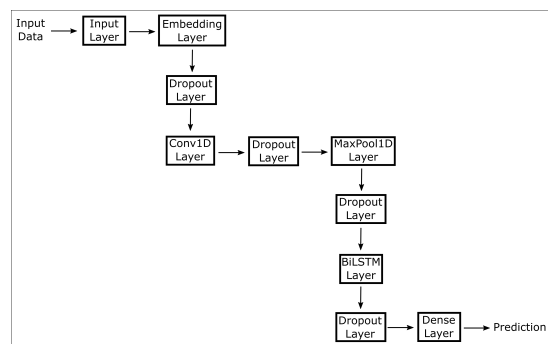

Figure 7: Structure of BiLSTM, embedding, and CNN model.

Table 11: Results for biLSTM with embedding.

Number of Unique Families to Classify	Accuracy Per Experiment (%)	Average Accuracy (%)
5	89.47	89.66
	90.83	
	89.95	
	85.94	
	92.12	
10	79.58	79.30
	79.54	
	78.13	
	78.79	
	80.46	
15	76.13	75.50
	76.13	
	76.66	
	76.28	
	72.31	
20	73.71	73.36
	74.74	
	69.53	
	74.10	
	74.72	

Table 12: Results for biLSTM, embedding, and CNN model.

Number of Unique Families to Classify	Accuracy Per Experiment (%)	Average Accuracy (%)
5	93.00	94.32
	96.33	
	92.73	
	94.70	
	94.32	
10	90.42	87.38
	90.29	
	81.29	
	89.58	
	85.29	
15	87.69	86.91
	87.56	
	82.59	
	87.31	
	89.41	
20	83.29	81.06
	76.34	
	80.60	
	82.18	
	82.88	

4.6 Comparison of Results

A bar graph of the average accuracies for each model is shown in Figure 8. As noted above, the basic LSTM model performs poorly, with each addition to the model improving our results.

The addition of an embedding layer dramatically

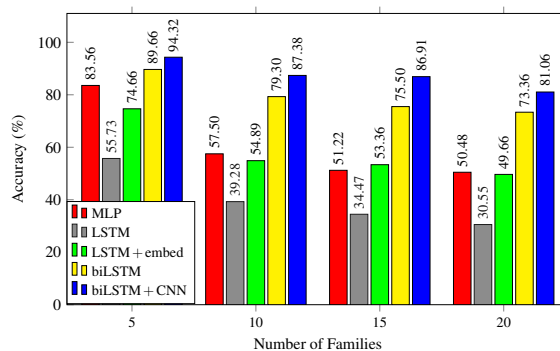

Figure 8: Comparison of the average evaluation accuracy.

increases the accuracy. This is not surprising, given that previous work has shown that embedding layers can greatly improve the accuracy of machine learning models applied to opcode sequences (Chandak et al., 2021).

BiLSTMs and word embedding are often used together in NLP applications. However, their use in malware research appears to be very uncommon to this point in time. Our models indicate that there is much to be gained by considering both the forward and backward opcode sequence.

Finally, the addition of a one-dimensional CNN layer to the biLSTM and embedding layers gives the best performance among the four models studied in this research. Compared to the model without a CNN layer, the addition of this layer seems to have greater impact to performance when classifying more than 5 families. A possible explanation for why this model performs so well is that in addition to the benefits that come from having an embedding and biLSTM layers, a CNN layer helps the model by providing a different perspective on the opcode sequences. Specifically, CNNs focus the model on local structure whereas the biLSTM is focused on overall characteristics. The interplay between these aspects—local and global—has the potential to provide the best of both, which we have married together into a single model. The addition of a max pooling layer serves to further highlight the crucial aspects of the local structure that the CNN highlights.

Confusion matrices for each model appear in the Appendix in Figures 10 through 13. These matrices show how often families are classified incorrectly and precisely where these misclassifications occur. For example, considering our best model results in Figure 13, we see that 4 families are badly misclassified, namely, Alureon, Obfuscator, Agent, and Rbot, with, respectively, only 36%, 31%, 25%, and 29% classified correctly. In contrast, 8 of the families are classified with 90% or greater accuracy.

5 CONCLUSION AND FUTURE WORK

In this research, we found that malware classification by family using long-short term memory (LSTM) models is feasible. However, using just a single LSTM layer alone yields poor results. We found that by incorporating techniques from natural language processing (NLP), specifically, word embedding and bidirectional LSTMs (biLSTM), greatly improves the performance. We also discovered that that we could get obtain even better performance by including a convolutional neural network (CNN) layer in our model. Our best model was able to classify samples from 20 different malware families with an average accuracy in excess of 81%. We conjecture that the interplay between the long-term memory of the biLSTM and the local structure found by the CNN are the key to obtaining this strong performance.

For future work, more can be done into investigating why applying NLP techniques are so effective in classifying malware. The addition of an embedding layer, greatly improved our model's overall accuracy. Other techniques can be considered. For example, we might apply principle component analysis (PCA) to reduce the dimensionality of the weights obtained from the embedding layer. Additionally, experiments involving different word embedding algorithms (e.g., GloVe) would be worthwhile. Finally, further research into the possible benefits of combining LSTMs and CNNs in this problem domain would be of great interest.

REFERENCES

- Athiwaratkun, B. and Stokes, J. W. (2017). Malware classification with LSTM and GRU language models and a character-level cnn. In *2017 IEEE International Conference on Acoustics, Speech and Signal Processing, ICASSP*, pages 2482–2486.
- Britz, D. (2015). Recurrent neural networks tutorial, introduction. <https://www.kdnuggets.com/2015/10/recurrent-neural-networks-tutorial.html>.
- Chandak, A., Lee, W., and Stamp, M. (2021). A comparison of word2vec, hmm2vec, and pca2vec for malware classification. In Stamp, M., Alazab, M., and Shalaginov, A., editors, *Malware Analysis using Artificial Intelligence and Deep Learning*. Springer.
- Cheng, J., Dong, L., and Lapata, M. (2016). Long short-term memory-networks for machine reading. <https://arxiv.org/abs/1601.06733>.
- Choudhary, S. and Sharma, A. (2020). Malware detection & classification using machine learning. In *2020 International Conference on Emerging Trends in Communication, Control and Computing, ICONC3*, pages 1–4.
- Chowdhury, N. and kashem, M. A. (2008). A comparative analysis of feed-forward neural network recurrent neural network to detect intrusion. In *2008 International Conference on Electrical and Computer Engineering*, pages 488–492.
- Cui, Z., Ke, R., Pu, Z., and Wang, Y. (2018). Deep bidirectional and unidirectional LSTM recurrent neural network for network-wide traffic speed prediction. <https://arxiv.org/abs/1801.02143>.
- Jain, M., Andreopoulos, W., and Stamp, M. (2020). Convolutional neural networks and extreme learning machines for malware classification. *Journal of Computer Virology and Hacking Techniques*, 16(3):229–244.
- Lu, R. (2019). Malware detection with LSTM using opcode language. <https://arxiv.org/abs/1906.04593>.
- Mikolov, T., Chen, K., Corrado, G., and Dean, J. (2013). Efficient estimation of word representations in vector space. <https://arxiv.org/abs/1301.3781>.
- Mikolov, T., Kombrink, S., Burget, L., Černocký, J., and Khudanpur, S. (2011). Extensions of recurrent neural network language model. In *2011 IEEE International Conference on Acoustics, Speech and Signal Processing, ICASSP*, pages 5528–5531.
- Mishra, P., Khurana, K., Gupta, S., and Sharma, M. K. (2019). Vmanalyzer: Malware semantic analysis using integrated CNN and bi-directional LSTM for detecting VM-level attacks in cloud. In *2019 Twelfth International Conference on Contemporary Computing, IC3*, pages 1–6.
- Mujumdar, A., Masiwal, G., and Meshram, D. B. (2013). Analysis of signature-based and behavior-based anti-malware approaches. *International Journal of Advanced Research in Computer Engineering and Technology*, 2(6).
- Nappa, A., Rafique, M. Z., and Caballero, J. (2015). The MALICIA dataset: Identification and analysis of drive-by download operations. *International Journal of Information Security*, 14(1):15–33.
- Prajapati, P. and Stamp, M. (2021). An empirical analysis of image-based learning techniques for malware classification. In Stamp, M., Alazab, M., and Shalaginov, A., editors, *Malware Analysis using Artificial Intelligence and Deep Learning*. Springer.
- Sewak, M., Sahay, S. K., and Rathore, H. (2018). Comparison of deep learning and the classical machine learning algorithm for the malware detection. In *19th IEEE/ACIS International Conference on Software Engineering, Artificial Intelligence, Networking and Parallel/Distributed Computing, SNPDC*, pages 293–296.
- Stamp, M. (2017). *Introduction to Machine Learning with Applications in Information Security*. Chapman & Hall/CRC, 1st edition.
- Stamp, M. (2019). Alphabet soup of deep learning topics. <https://www.cs.sjsu.edu/~stamp/RUA/alpha.pdf>.
- Tahir, R. (2018). A study on malware and malware detection techniques. *International Journal of Education and Management Engineering*, 8(2):20–30.
- Tavakoli, N. (2019). Modeling genome data using bidirectional LSTM. In *2019 IEEE 43rd Annual Computer Software and Applications Conference*, volume 2 of *COMPSAC*, pages 183–188. IEEE.

TensorFlow Core v.2.3.0 API (2020). Tensorflow core v.2.3.0 api. https://www.tensorflow.org/api_docs/python/tf.

Williams, O. (2018). The WannaCry ransomware attack left the NHS with a 73m IT bill. <https://tech.newstatesman.com/security/cost-wannacry-ransomware-attack-nhs>.

Zhang, J. (2020). Deepmal: A CNN-LSTM model for malware detection based on dynamic semantic behaviours. In *2020 International Conference on Computer Information and Big Data Applications, CIBDA*, pages 313–316.

APPENDIX

Here, we provide confusion matrices for each of our experiments in Section 4.

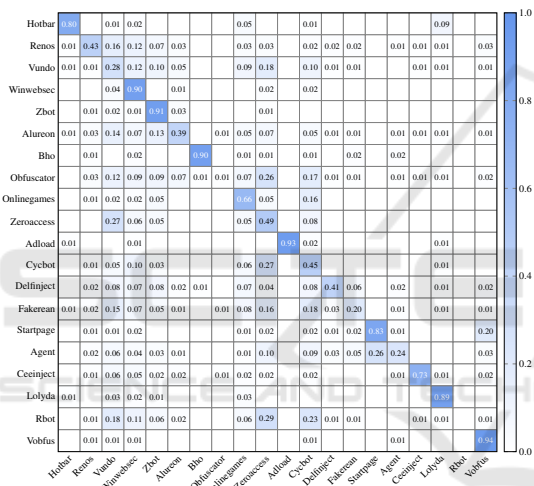

Figure 9: Confusion matrix for model using MLP only.

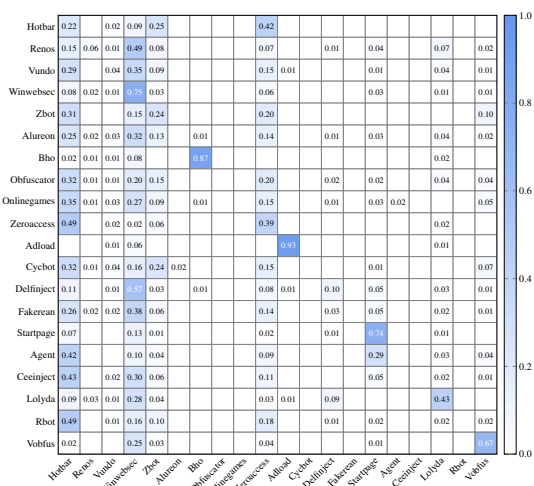

Figure 10: Confusion matrix for LSTM without embedding.

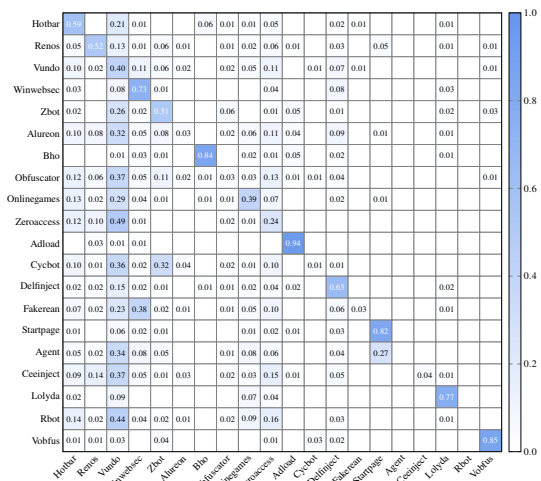

Figure 11: Confusion matrix for LSTM with embedding.

