

# Faceshield HUD: Extended Usage of Wearable Computing on the COVID-19 Frontline

Mateus C. Silva<sup>1,3</sup><sup>a</sup>, Ricardo A. R. Oliveira<sup>1</sup><sup>b</sup>, Thiago D'angelo<sup>1</sup>, Charles T. B. Garrocho<sup>1,4</sup><sup>c</sup>  
and Vicente J. P. Amorim<sup>2</sup><sup>d</sup>

<sup>1</sup>*Departamento de Computação, Instituto de Ciências Exatas e Biológicas, Universidade Federal de Ouro Preto, Brazil*

<sup>2</sup>*Departamento de Computação e Sistemas, Instituto de Ciências Exatas e Aplicadas, Universidade Federal de Ouro Preto, Brazil*

<sup>3</sup>*Instituto Federal de Educação, Ciência e Tecnologia de Minas Gerais, Campus Avançado Itabirito, Brazil*

<sup>4</sup>*Instituto Federal de Educação, Ciência e Tecnologia de Minas Gerais, Campus Ouro Branco, Brazil*

**Keywords:** Wearable Computing, Edge Computing, Smart Healthcare, IoT, COVID-19.

**Abstract:** Wearable Computing brings up novel methods and appliances to solve various problems in society's routine tasks. Also, it brings the possibility of enhancing human abilities and perception throughout the execution of specialist activities. Finally, the flexibility and modularity of wearable devices allow the idealization of multiple appliances. In 2020, the world faced a global threat from the COVID-19 pandemic. Healthcare professionals are directly exposed to contamination and therefore require attention. In this work, we propose a novel wearable appliance to aid healthcare professionals working on the frontline of pandemic control. This new approach aids the professional in daily tasks and monitors his health for early signs of contamination. Our results display the system feasibility and constraints using a prototype and indicate initial restrictions for this appliance. This proposal also works as a benchmark for the aid in health monitoring in general hazardous situations.

## 1 INTRODUCTION

With the hardware miniaturization, the inclusion of Graphics Processing Unit (GPU), and processor supportive Artificial Intelligence's (AI) appliances in System On Chip (SoC), wearable computers turn to be also classified as edge computing devices (Chen et al., 2017). This perspective implies better and more flexible electronics and modular Computers-on-Chips. These devices can perform a higher engagement on local processing tasks (Kim et al., 2017). Also, given their network capabilities, they can feed data with a higher abstraction level to an edge-server-based or cloud-based applications (Ren et al., 2017).

A significant factor in wearable computing is the context-awareness (Grubert et al., 2016). At a first glimpse, this information relates to detecting changes

in the environment's conditions in pervasive applications (Surve and Ghorpade, 2017). Nonetheless, another essential part of the context-awareness is the user's conditions monitoring (Silva et al., 2019; Amft, 2018), henceforth named user-awareness.

According to Kliger and Silberzweig (Kliger and Silberzweig, 2020), the COVID-19 is a coronavirus disease caused by a novel coronavirus. The main identified symptoms are fever, cough, myalgia, and fatigue. Prachand et al. (Prachand et al., 2020) state that a compelling factor in the fight against the pandemic is the healthcare professionals' exposure to contamination risks. Still, according to Kliger and Silberzweig (Kliger and Silberzweig, 2020), face masks and face shields are among the recommended personal protection equipment (PPE) adopted by healthcare professionals to avoid contamination.

In this work, we propose the architecture for a novel wearable appliance to help the professionals in the frontline of the COVID-19 engagement. The proposed appliance has two main goals. The first one is to gather information from environment signals using

<sup>a</sup>  <https://orcid.org/0000-0003-3717-1906>

<sup>b</sup>  <https://orcid.org/0000-0001-5167-1523>

<sup>c</sup>  <https://orcid.org/0000-0001-8245-306X>

<sup>d</sup>  <https://orcid.org/0000-0001-9043-6489>

a camera as a smart sensor. The other one is to monitor the medical professionals' health conditions using internal measurement sensors. We also prototyped a version of the proposed architecture to test its feasibility and features.

This device is a Head-Up Display (HUD) adapted to a safety face shield. This perspective follows the usage of an extra protection layer, recommended by the WHO for protection against direct contamination (Organization et al., 2020). Also, the proposed appliance seeks to provide context-awareness, both from the environmental conditions and user-awareness perspectives. Thus, the main contribution of this work is:

- An architecture for a HUD based on a face shield to aid healthcare professionals on the COVID-19 frontline.

This text's remainder is organized as follows: In Section 2, we discuss the theoretical basis for this work and the most related articles to the proposal. Section 3 presents the architecture proposal, with the required elements to gather and produce the proposed appliance. In Section 4, we present the developed prototypes to validate the ideas, as well as the tests applied to evaluate the proposal. We present the results of these tests in Section 5 and discuss the outcomes of this work in Section 6.

## 2 THEORETICAL REFERENCES AND RELATED WORK

In this section, we present the theoretical background and basic concepts applied in this proposal. We also analyze the literature to understand the most related recent works and how they contribute and differ from our proposal.

### 2.1 Wearable and Edge Computing

The trend of developing novel wearable devices with networking capabilities and forming an interconnected environment enables creating a wearable Internet of Things (IoT) (Cooney et al., 2018). These systems are based on edge miniaturized computers that can retrieve, store, and transmit environmental and user data (Jia et al., 2018).

Edge-Based Wearable Systems are vastly used in activity recognition (Salkic et al., 2019), healthcare and augmented (Manogaran et al., 2019) or assisted cognition (Zhao et al., 2020). These perspectives mean that edge wearable devices explore both environmental perception and user-awareness in the gen-

eral context-awareness goal. Recent works show a new trend in exploring both aspects of the global context-awareness concept (Silva et al., 2019). Using these concepts, we expect to propose a wearable system architecture to help in the COVID-19 frontline.

### 2.2 Head-Up Display (HUD)

A HUD is an instrument to present information in a display superimposed by the environment (Weintraub et al., 1985). HUDs are widely used in automotive (Betancur et al., 2018; Wang et al., 2018) and aviation (Stanton et al., 2018; Blundell et al., 2020) appliances. These devices are a way for wearable systems to increase cognition and environmental perception.

From the healthcare perspective, there are some validated devices healthcare (Kim et al., 2017), especially for surgical appliances (Liounakos et al., 2020). Even evaluating augmented reality tools in healthcare, most of the works provide surgical stress simulation for educational purposes (Gerup et al., 2020).

Nevertheless, there is still no perspective or related work regarding using a HUD connected to frontline professionals' face shield. The only similar approach is a face mask HUD created to increase firefighters' cognition in action (Rumsey and Le Dantec, 2019). Thus, this idea presents a novelty in academic approaches that can improve frontline conditions for workers facing the COVID-19 pandemics.

### 2.3 Edge Computing Smart Health Monitoring

A final relevant aspect of this perspective is the usage of edge computing in the smart health monitoring system. The advance of the IoT and the hardware miniaturization enhance AI algorithms' usage on edge devices (Lin et al., 2019). In the context of wearable computing, the primary areas previously explored in smart healthcare include children's safety, infant and older adults care, chronic disease management, military, sports medicine, and preventive medicine (Caselman et al., 2017).

These same concepts and design principles are vastly employed in healthcare appliances (Chen et al., 2018). For instance, these systems can monitor patients in healthcare facilities (Vippalapalli and Ananthula, 2016), authentication using authentication using Electroencephalogram (EEG) signal (Zhang et al., 2018), and early detection of disease symptoms (Al-hussein and Muhammad, 2019). All these concepts are relevant to the construction of the architecture presented in this work.

### 3 ARCHITECTURE PROPOSAL

In this section, we apply this knowledge to propose a novel high-level architecture of the wearable appliance. We chose the protective face shield as a baseline for this architecture development.

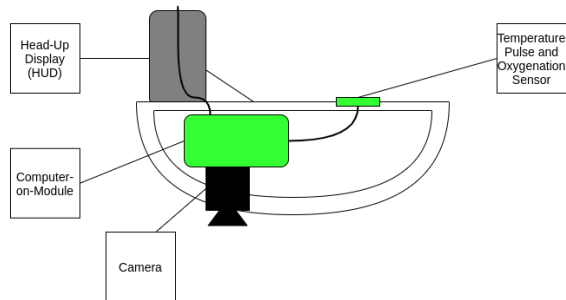

Figure 1: Schematic View of the Proposed Prototype.

The proposed architecture has one element to sense the environment, one sensor to overview the user's health conditions, and a HUD interface. All these elements integrate using an embedded computer-on-module, powered by a battery. Figure 1 displays a schematic view of the elements organization. For sensing the environment, we propose the usage of a camera. At the first moment, this sensor allows accessing the patients' medical records remotely. The internal application recognizes the patient using a QR-Code, displaying the most relevant information using the HUD. For sensing the user's health conditions, we propose the usage of a pulse-oximetry and temperature sensor. This module provides information about the users' temperature, blood oxygenation, and pulse conditions throughout the usage period. The interface for user awareness is a built-in HUD. It uses a small Organic Light-Emitting Diode (OLED) display with a semi-reflexive surface and a lens to produce the desired see-through effect. As the display is small-sized, only a limited set of information can be displayed. These elements integrate with an ARM-based single-core computer-on-module. This board has wireless networking characteristics to integrate with the local network. This feature allows the transmission of the user's data and the reception of information about patients stored in the local servers.

### 4 PROTOTYPING AND VALIDATION TESTS

This section presents the produced prototype to validate this idea and the tests used to evaluate its performance.

#### 4.1 Prototype Description

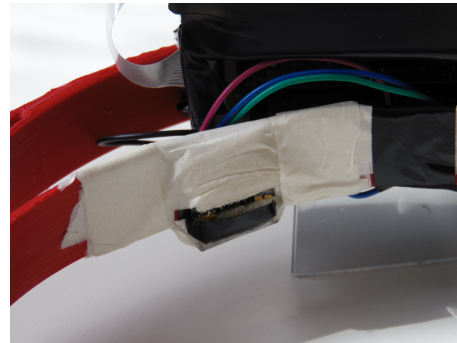

Figure 2: Pulse-Oxymeter and Temperature Sensor Placement.

To produce the prototype, at first, we started with a 3D-printed face shield base. This base is the same volunteers use to create face shield masks. Over this base, we settled all the necessary elements to create the proposed application. The computer-on-module was a Raspberry Pi Zero W. This solution has a single-core ARMv7 processor on a Broadcom BCM2835 chipset. This CPU bears up to 1GHz of clock frequency. It has 512MB of RAM and a wireless board with an 802.11 b/g/n WLAN connection, Bluetooth 4.1, and BLE protocols. We used a plastic case to arrange the computer-on-module and connected the other elements to it using wires. The whole produced solution weighs circa 200g, including the battery.



Figure 3: HUD See-through Display.

For sensing the patients' health conditions, we used a MAX30100<sup>1</sup> pulse-oximeter. This sensor provides information to calculate the users' pulse, blood oxygenation, and temperature. It is powered using a 3.3V output built on the computer-on-module and communicates using an I<sup>2</sup>C/SMBus serial connection. Figure 2 displays the placement of this sensor in the proto-

<sup>1</sup><https://datasheets.maximintegrated.com/en/ds/MAX30100.pdf>

type. We used a Raspicam V2 module<sup>2</sup> for sensing the environment. This appliance has an 8 megapixels still resolution, providing 1080p, 720p, and 480p video modes, and is accessible using the V4L2 Linux driver. It has 62.2 degrees of horizontal field-of-view and 48.8 degrees of vertical field-of-view. This device connects to the central computer using the MIPI camera serial interface.

Finally, the user interface is a HUD, which displays the information in front of the user's right eye. For this matter, we used a 96x64 pixels OLED display<sup>3</sup> in a 3D-printed case. This module communicates using an SPI serial connection. The reflexive surface was created using a semi-reflexive membrane in front of an acrylic layer. We placed a lens with the correct calculated focal distance to display the information at the correct distance. Figure 3 shows an example of the information available using this model of the see-through display.

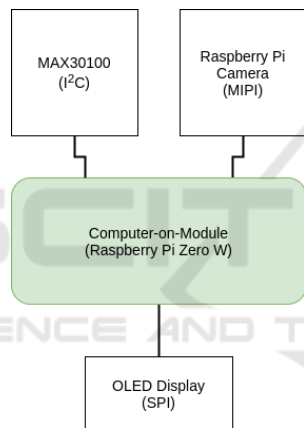

Figure 4: Data Flow for the Proposed Prototype.

The computer-on-module continuously acquires data from its sensors. Using its wireless capabilities, it sends this data to a server to store the information and retrieves some information based on the sensed data. Finally, it produces the HUD screen's feedback frame according to the received answer and the sensors' data. Figure 4 represents the systems' data flow from the information pictured in this section.

## 4.2 Validation Tests

In this subsection, we present the test set used to validate the proposed solution. For testing matters, we will test different aspects of the system. A wear-

<sup>2</sup><https://www.raspberrypi.org/documentation/hardware/camera/>

<sup>3</sup>[https://img.filipeflop.com/files/download/Datasheet\\_SSD1331.pdf](https://img.filipeflop.com/files/download/Datasheet_SSD1331.pdf)

able appliance is an energy-constrained device (Hong et al., 2019; Gia et al., 2018). Also, the processing consumption is a relevant constraint in this context (Sörös et al., 2015). Finally, we also want to validate some functional aspects of the system. Thus, our test set considers:

1. A **current consumption profiling test**, to observe how the proposed device behaves due to processing charge;
2. A **full battery discharge test**, for probing the energy constraint and autonomy;
3. A **functional validation test**, to observe how the system reads the provided data.

For the first two tests, we used a data acquisition system to provide real-time information about the consumption using a sensor and a microcontroller. The sensor was an INA219 current consumption sensor, and the microcontroller was an Arduino Uno. Figure 5 displays the configuration for this probe.

For a single value output, we take the average measurement of 20 samples spaced at approximately 100 samples/s. The final sampling rate for obtaining a single value was approximately 4.5 samples/s.

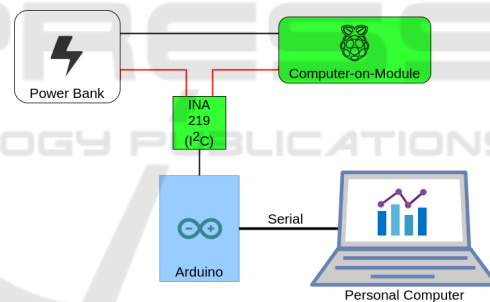

Figure 5: Current Consumption Probe Configuration.

In the **current consumption profiling test**, we observe how the system consumes energy in different stages of its functioning. For this matter, we performed a current consumption test considering various stages of the system functioning. We performed a 210-second run using a 5V power source. In this experiment, the device runs the following states in the approximate time intervals:

1. Device off – 0s-10s;
2. Boot – 10s-65s;
3. SSH enabled – Idle – 65s-110s;
4. Run application – 110s-180s;
5. SSH enabled – Idle – 180s-200s;
6. Device off – 200s-210s.



With this metric, we expect to analyze the current consumption of the system’s different possible states. Also, we expect to understand the system’s energetic constraints better. For broader comprehension, we also perform the next described test.

In the **full battery discharge test**, we expect to analyze two different aspects. At first, we want to evaluate the system autonomy given a specific power source. Also, we want to evaluate the consumption steadiness throughout the whole execution time. This evaluation considers quantitative and qualitative traits. Current consumption without massive leaps mainly displays robustness on the behavior. Also, it is necessary to determine the autonomy of this system, considering the other presented constraints.

Finally, we also perform a **functional validation test**. With this, we evaluate the system’s feasibility and additional features through its fundamental aspects. We analyze both user-awareness and environment-awareness sensing tools, considering the information extraction and transmission to an external edge server appliance. We enable the usage of Edge AI to evaluate the traits of the presented data within this appliance.

## 5 VALIDATION TESTS RESULTS

In this section, we present the results for these tests and preliminary discussions and conclusions.

### 5.1 Current Consumption Profiling Test

The first proposed experiment is the current consumption profiling test. In this scope, we want to describe the functioning of the system throughout different stages. For this matter, we divided the test time into six stages: Device off (1), Boot (2), SSH enabled - Idle (3), Run application (4), SSH enabled - Idle (5), and Device off (6). This test represents roughly a “symmetrical” startup, execution, and shutdown from the prototype. Figure 6 displays the results obtained from this experiment.

In red, we display the probe readings when the system was off (Stages 1 and 6). These results display some noise but roughly represent the “zero-state” of this system. In orange, we display the current consumption results in the system boot (Stage 2). In this case, it is possible to see that the reading values increase until reaching a stable state.

In yellow, we display the results for the “SSH enabled - Idle” stages (3 and 5). In these intervals, the system was on, and the ssh connection was established. Nonetheless, the application was not running

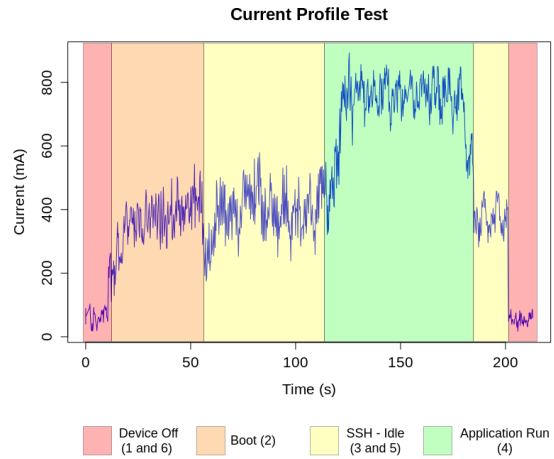

Figure 6: Current Consumption Profiling Test Result.

yet, configuring an idle state. At the connection establishment, we observe some instability in the current consumption, which reaches a stable state right after.

Finally, in green, we display the current consumption result for the application run time. In this case, the device starts the application, acquiring and transmitting data. In this case, the prototype is consuming the fully required resources. From the data, it is possible to see that the current increases during the system start-up, reaching a stable state after some seconds. The system also displays a slope decrease on the current, reaching a stable level in the shutdown’s idle state. Table 1 displays the average current consumption for each stage.

Table 1: Profiling Test Results.

|         | Current (mA) |      |               |
|---------|--------------|------|---------------|
|         | min.         | max. | avg.          |
| Stage 1 | 3            | 86   | 45.53 ± 22.27 |
| Stage 2 | 56           | 529  | 331.4 ± 86.6  |
| Stage 3 | 232          | 565  | 384.4 ± 65.8  |
| Stage 4 | 744          | 927  | 831.4 ± 32.6  |
| Stage 5 | 268          | 444  | 359.5 ± 45.0  |
| Stage 6 | 3            | 73   | 40.63 ± 14.0  |

### 5.2 Full Battery Discharge Test

After profiling the current consumption for each presented stage, we also performed a discharge test. In this experiment, we use a small battery as a candidate for bearing the appliance and measure the autonomy and average current consumption. Figure 7 displays the measurement results for the whole test period.

We used a lightweight 4000 mAh power bank as the system battery for this test. The average current was  $779.3 \pm 58.7$  mA during the test, with a registered peak of 939 mA. The prototype presented

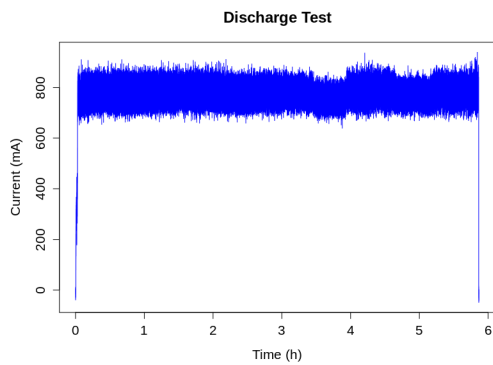

Figure 7: Discharge Test Result.

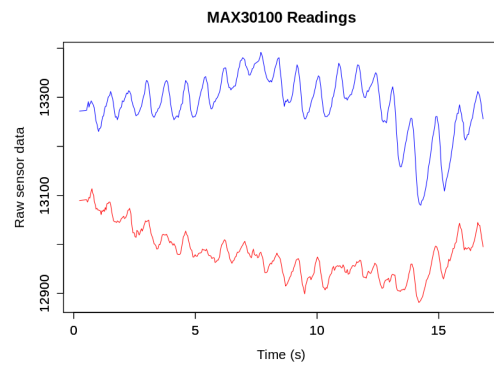

Figure 9: MAX30100 Probe Readings.

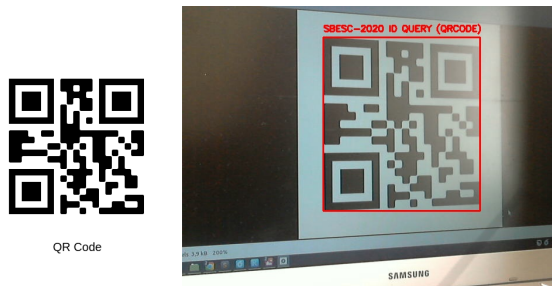

Figure 8: QR Code Acquisition Validation.

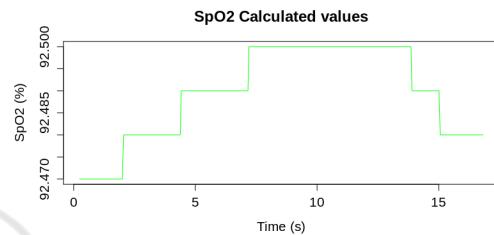

Figure 10: SpO<sub>2</sub> Readings Obtained from the Computer-on-Module.

a steady behavior during the whole test execution, which indicates robustness for this appliance. Also, the autonomy was circa 6 hours of straight operation. These results corroborate with the profiling test results, indicating the solution feasibility and predictable behavior. This information also allows the selection of an adequate power source according to healthcare workers' actual demands.

### 5.3 Functional Validation Test

Finally, we performed a functional validation on the prototype to check its feasibility in a scenario that approaches the final user's context. In the proposed appliance, we expect to extract two different kinds of information. We expect to recognize information from the environment using a camera and extract information from the user through a built-in sensor.

At first, we verified the feasibility of the external sensor. Initially, it only works as a detector for a QR code to retrieve other intelligent sensors' information. Thus, our conjecture considers the wearable camera as an image extracting sensor. The system acquires and sends frames to an edge computing server for processing.

For this matter, we integrated a streamer application into the appliance. Thus, at any moment, the edge computing server can establish a connection with the wearable, acquiring a single frame and processing it

to search for the QR code with an identification query. Therefore, we developed a simple application that can retrieve data from the wearable device and scan it for a QR code. Figure 8 displays the final result for this example.

After validating the external data acquisition process, we also needed to validate the user's health conditions data acquisition. In this prototype, we used the MAX30100, which provides information from temperature and pulse-oxymetry. In this application, the wearable calculates the blood oxygen saturation (SpO<sub>2</sub>) data considering measurements from IR and red light LED pulses. The absorption of red light and IR light differs in hemoglobin with and without oxygen. Figure 9 displays the probe sensor sampling readings at a rate of around 23 samples/s for circa 15 seconds. The blue line displays the infrared pulses' readings, while the red line presents the readings for the red light pulses.

Typically, the data can be interpreted through the AC components normalized by the DC components (Tremper and Barker, 1989). The computer-on-module interprets the readings as SpO<sub>2</sub>. Figure 10 shows the acquired data from the computer-on-module. The pulse information can be obtained simply by counting the number of peaks in a specified time interval. The generated data can be evaluated later on the edge computing server appliance with machine learning techniques to analyze the time series.

The analyzes carried on the prototype provide functional and non-functional validation of all aspects of the proposed architecture. We validated the main elements necessary for the prototype to integrate into the proposed appliance through the functional analysis. In the non-functional analysis, we determine the constraints for a robust operation using the proposed system.

## 6 CONCLUSIONS AND FUTURE WORKS

In this text, we propose a wearable device architecture to improve the healthcare professionals' conditions in the COVID-19 frontline. This device is based on a computer-on-module, enabling the external acquisition of data and further processing using Edge AI. We also developed a prototype to validate the functional and non-functional aspects of the proposed solution.

Our proposed device base is a protective face shield. This device is a part of the protective gear used by healthcare professionals against contamination from the COVID-19. The appliance is centered in a computer-on-module capable of acquiring data from a camera and transmits it to a web-based application. The approach acquires data from a pulse oximeter and calculates oxygen saturation, transmitting the pre-processed data to create a time-series.

We produced a prototype to validate this architecture, containing the necessary elements to perform a set of tasks. This approach acquires data from a camera and transmits it to a web-based application. The approach acquires data from a pulse oximeter and calculates oxygen saturation, transmitting the pre-processed data to create a time-series.

To validate this prototype and appliance, we proposed three tests. At first, we create a constraint profile from the appliance evaluating the energy consumption in different scenarios. Then, we perform a full discharge test to evaluate the autonomy and robustness of this system. Finally, we performed a set of validation tests of the functional aspects of this system.

At first, we evaluated the results for the profiling test. Our experiment displays a predictable behavior given in a particular state. When the prototype is turned on and in an idle state, we expect the consumption of circa 300-330 mA for maintaining the necessary networking and operating system tasks. When the application is fully operational, we expect an increase of circa 500 mA, reaching an average of around 830 mA.

Both these constraints were observed in the discharge test. This experiment displayed a stable functioning, with an autonomy of around six hours using a small battery. Finally, in these conditions, we per-

formed all desired tasks displayed in the functional validation test.

These results enforce the feasibility of this device, which can aid in remote healthcare in medical facilities. Future work should evaluate the usage of multiple devices in an integrated network to evaluate the constraints given an appliance closer to the real context.

## ACKNOWLEDGEMENTS

The authors would like to thank CAPES, CNPq, and the Federal University of Ouro Preto for supporting this work. This study was financed in part by the Coordenação de Aperfeiçoamento de Pessoal de Nível Superior - Brasil (CAPES) - Finance Code 001.

## REFERENCES

- Alhussein, M. and Muhammad, G. (2019). Automatic voice pathology monitoring using parallel deep models for smart healthcare. *IEEE Access*, 7:46474–46479.
- Amft, O. (2018). How wearable computing is shaping digital health. *IEEE Pervasive Computing*, 17(1):92–98.
- Betancur, J. A., Villa-Espinal, J., Osorio-Gómez, G., Cuéllar, S., and Suárez, D. (2018). Research topics and implementation trends on automotive head-up display systems. *International Journal on Interactive Design and Manufacturing (IJIDeM)*, 12(1):199–214.
- Blundell, J., Scott, S., Harris, D., Huddleston, J., and Richards, D. (2020). With flying colours: Pilot performance with colour-coded head-up flight symbology. *Displays*, 61:101932.
- Casselmann, J., Onopa, N., and Khansa, L. (2017). Wearable healthcare: Lessons from the past and a peek into the future. *Telematics and Informatics*, 34(7):1011–1023.
- Chen, M., Li, W., Hao, Y., Qian, Y., and Humar, I. (2018). Edge cognitive computing based smart healthcare system. *Future Generation Computer Systems*, 86:403–411.
- Chen, Z., Hu, W., Wang, J., Zhao, S., Amos, B., Wu, G., Ha, K., Elgazzar, K., Pillai, P., Klatzky, R., et al. (2017). An empirical study of latency in an emerging class of edge computing applications for wearable cognitive assistance. In *Proceedings of the Second ACM/IEEE Symposium on Edge Computing*, pages 1–14.
- Cooney, N. J., Joshi, K. P., and Minhas, A. S. (2018). A wearable internet of things based system with edge computing for real-time human activity tracking. In *2018 5th Asia-Pacific World Congress on Computer Science and Engineering (APWC on CSE)*, pages 26–31. IEEE.
- Gerup, J., Soerensen, C. B., and Dieckmann, P. (2020). Augmented reality and mixed reality for healthcare education beyond surgery: an integrative review. *Int J Med Educ*, 11:1–18.

- Gia, T. N., Sarker, V. K., Tcareenko, I., Rahmani, A. M., Westerlund, T., Liljeberg, P., and Tenhunen, H. (2018). Energy efficient wearable sensor node for iot-based fall detection systems. *Microprocessors and Microsystems*, 56:34–46.
- Grubert, J., Langlotz, T., Zollmann, S., and Regenbrecht, H. (2016). Towards pervasive augmented reality: Context-awareness in augmented reality. *IEEE transactions on visualization and computer graphics*, 23(6):1706–1724.
- Hong, S., Gu, Y., Seo, J. K., Wang, J., Liu, P., Meng, Y. S., Xu, S., and Chen, R. (2019). Wearable thermoelectrics for personalized thermoregulation. *Science advances*, 5(5):eaaw0536.
- Jia, G., Han, G., Xie, H., and Du, J. (2018). Hybrid-lru caching for optimizing data storage and retrieval in edge computing-based wearable sensors. *IEEE Internet of Things Journal*, 6(2):1342–1351.
- Kim, J., Gutruf, P., Chiarelli, A. M., Heo, S. Y., Cho, K., Xie, Z., Banks, A., Han, S., Jang, K.-I., Lee, J. W., et al. (2017). Miniaturized battery-free wireless systems for wearable pulse oximetry. *Advanced functional materials*, 27(1):1604373.
- Kliger, A. S. and Silberzweig, J. (2020). Mitigating risk of covid-19 in dialysis facilities. *Clinical Journal of the American Society of Nephrology*, 15(5):707–709.
- Lin, X., Li, J., Wu, J., Liang, H., and Yang, W. (2019). Making knowledge tradable in edge-ai enabled iot: A consortium blockchain-based efficient and incentive approach. *IEEE Transactions on Industrial Informatics*, 15(12):6367–6378.
- Liounakos, J. I., Urakov, T., and Wang, M. Y. (2020). Head-up display assisted endoscopic lumbar discectomy—a technical note. *The International Journal of Medical Robotics and Computer Assisted Surgery*, 16(3):e2089.
- Manogaran, G., Shakeel, P. M., Fouad, H., Nam, Y., Baskar, S., Chilamkurti, N., and Sundarasekar, R. (2019). Wearable iot smart-log patch: An edge computing-based bayesian deep learning network system for multi access physical monitoring system. *Sensors*, 19(13):3030.
- Organization, W. H. et al. (2020). Advice on the use of masks in the context of covid-19: interim guidance, 6 april 2020. Technical report, World Health Organization.
- Prachand, V. N., Milner, R., Angelos, P., Posner, M. C., Fung, J. J., Agrawal, N., Jeevanandam, V., and Matthews, J. B. (2020). Medically-necessary, time-sensitive procedures: A scoring system to ethically and efficiently manage resource scarcity and provider risk during the covid-19 pandemic. *Journal of the American College of Surgeons*.
- Ren, J., Guo, H., Xu, C., and Zhang, Y. (2017). Serving at the edge: A scalable iot architecture based on transparent computing. *IEEE Network*, 31(5):96–105.
- Rumsey, A. and Le Dantec, C. A. (2019). Clearing the smoke: The changing identities and work in firefighters. In *Proceedings of the 2019 on Designing Interactive Systems Conference*, pages 581–592.
- Salkic, S., Ustundag, B. C., Uzunovic, T., and Golubovic, E. (2019). Edge computing framework for wearable sensor-based human activity recognition. In *International Symposium on Innovative and Interdisciplinary Applications of Advanced Technologies*, pages 376–387. Springer.
- Silva, M. C., Amorim, V. J., Ribeiro, S. P., and Oliveira, R. A. (2019). Field research cooperative wearable systems: Challenges in requirements, design and validation. *Sensors*, 19(20):4417.
- Sörös, G., Semmler, S., Humair, L., and Hilliges, O. (2015). Fast blur removal for wearable qr code scanners. In *Proceedings of the 2015 ACM International Symposium on Wearable Computers*, pages 117–124.
- Stanton, N. A., Roberts, A. P., Plant, K. L., Allison, C. K., and Harvey, C. (2018). Head-up displays assist helicopter pilots landing in degraded visual environments. *Theoretical issues in ergonomics science*, 19(5):513–529.
- Surve, A. R. and Ghorpade, V. R. (2017). Pervasive context-aware computing survey of context-aware ubiquitous middleware systems. *International Journal of Engineering10. 1*.
- Tremper, K. K. and Barker, S. J. (1989). Pulse oximetry. *Anesthesiology: The Journal of the American Society of Anesthesiologists*, 70(1):98–108.
- Vippalapalli, V. and Ananthula, S. (2016). Internet of things (iot) based smart health care system. In *2016 International Conference on Signal Processing, Communication, Power and Embedded System (SCOPES)*, pages 1229–1233. IEEE.
- Wang, W., Zhu, X., Chan, K., and Tsang, P. (2018). Digital holographic system for automotive augmented reality head-up-display. In *2018 IEEE 27th International Symposium on Industrial Electronics (ISIE)*, pages 1327–1330. IEEE.
- Weintraub, D. J., Haines, R. F., and Randle, R. J. (1985). Head-up display (hud) utility, ii: Runway to hud transitions monitoring eye focus and decision times. In *Proceedings of the Human Factors Society Annual Meeting*, volume 29, pages 615–619. SAGE Publications Sage CA: Los Angeles, CA.
- Zhang, Y., Gravina, R., Lu, H., Villari, M., and Fortino, G. (2018). Pea: Parallel electrocardiogram-based authentication for smart healthcare systems. *Journal of Network and Computer Applications*, 117:10–16.
- Zhao, S., Wang, J., Leng, H., Liu, Y., Liu, H., Siewiorek, D. P., Satyanarayanan, M., and Klatzky, R. L. (2020). Edge-based wearable systems for cognitive assistance: Design challenges, solution framework, and application to emergency healthcare.