

Battery Thermal Management Systems for EVs and Its Applications: A Review

Haosong He¹ ^a, Vishal Saini² ^b and Xiangjie Chen¹

¹*School of Mechanical, Electrical and Manufacturing Engineering, Loughborough University, Epinal Way, Loughborough, U.K.*

²*Department of Aeronautical and Automotive Engineering, Loughborough University, Loughborough, U.K.*

Keywords: Battery Thermal Management System, Electric Vehicle, Review, Lithium-ion.

Abstract: Electric vehicles (EVs) are a viable alternatives to achieve zero greenhouse gas emission goals. However, the prime clean power source choice- Lithium-ion battery is sensitive to temperature, thus requires a battery thermal management system (BTMS) to secure its performance and safety. Nowadays, most commercial EVs implement liquid BTMS because the liquids are expected to have high heat transfer efficiency with both cooling or heating capabilities. This paper firstly reviews the adverse effects of temperature on the battery performance from three aspects: high temperature, low temperature and temperature difference. Then three commercialised BTMSs: air cooling BTMS, liquid cooling BTMS, and refrigerants BTMS, are introduced, and the main advantages and disadvantages for each BTMS strategy are discussed. Finally, this paper presents main BTMS applications the BTMS applications for EVs on market.

1 INTRODUCTION

The UK's industrial strategy states that the transition from fossil fuel cars to zero-emission vehicles is crucial to maintain the UK's international competitiveness in the automotive industry (Slowik et al., 2019). EVs are regarded as a promising approach to replace the traditional internal combustion engine vehicles to achieve zero-emission goal (Wu et al., 2019). Since the commercialisation of Lithium-ion batteries by Sony in 1991, Lithium-ion batteries are extensively used in various fields. With the rapid development of Lithium-ion battery technologies, these batteries are also fast becoming the optimal choice for EVs. This is due to their outstanding strengths, such as high-power density, long cycle life, low self-discharge rate and no memory effect (Reddy, 2011). The critical obstacles to date for the market penetration of EVs lies in its energy storage system. Lithium-ion batteries' effective capacity is strongly associated with its discharging rate, cycle number, and temperature. Extensive studies have proved that batteries discharge capacity decays with the increasing temperature, discharging currents and cycling times. The discharging rate and charging cycle are associated with

EVs' real-time working conditions and the batteries service time. Temperature, therefore, is the only element that can be actively controlled in driving and becomes a vital subject to be investigated.

Temperature can significantly affect battery life, performance, safety aspects due to the inherent chemical properties of Lithium-ion batteries. Batteries can generate enormous heat during their cycling due to the overpotential, and the resulting high temperatures lead to degraded battery performance (Ma et al., 2018). Furthermore, the low temperatures increase the internal resistance of batteries due to the increased viscosity of electrolyte that leads to the reduced charging and discharging capacity, resulting in a compromised effective mileage of EVs (Wu et al., 2019). Additionally, a low-temperature fast charge can exacerbate Lithium dendrites formation, causing irreversible loss of active battery materials and increasing the potential of internal short circuits within the battery. Thus, to prolong the cycle life and maximize the capability of power cells, automotive manufacturers adopt battery thermal management systems (BTMSs) to actively control the operating temperature range and minimize the temperature gradients inside the battery pack.

BTMS is a critical subsystem of the battery management system (BMS) aiming to maintain the sys-

^a  <https://orcid.org/0000-0001-9333-1068>

^b  <https://orcid.org/0000-0002-6774-7921>

tem operating under an efficient and safe temperature range. In addition, it assists cells to operate under the same conditions, making the cell ageing uniform. This improves EVs' safety, driving range, lifespan, and cost. At EV's level, delicate mechanical integration of BTMS and battery pack is crucial to reduce the potential abuse probabilities such as over charge, over discharge, over heat, over cooling and increase the robustness in extreme incidents, e.g., crash situations or cabin intrusion (Scrosati et al., 2015). At battery and cell levels, various safety factors need to be considered in battery design and usages, such as battery pack/cell's voltage and current limits, temperatures, and temperature gradients (Motors et al., 2007). The primary task for BTMS is to maintain the temperature in an optimal region, detect any unexpected temperature changes, prevent temperatures runaway in cells and further propagation among cells/modules. Other auxiliary functions include minimising the impact of the external ambient temperature on the battery pack, minimising the temperature differences between and within the individual cells, and necessary humidity control.

Numerous approaches have been developed in the past years for thermal management of EV batteries by considering different factors. This paper presents a systematic review of various BTMSs for EVs, including the adverse effects of temperature on Lithium-ion batteries. In addition, the approaches taken up by the EV industry, with applications to current commercial EVs are discussed.

2 BATTERY THERMAL MANAGEMENT SYSTEM

BTMS needs to consider the temperature influence on battery pack level and the individual cell level.

Battery Pack Level. Non-uniform temperature distribution within battery packs is inevitable because the electrochemical characteristics of each cell, including capacity, voltage and internal resistance, cannot be identical. More importantly, the heat transfer efficiency within the battery pack varies with the cells positions and the pack layout. Fig. 1 exemplifies that the side cells have a lower temperature compared to the other cells in between due to more convection heat transfer on the side (Akbarzadeh et al., 2020). Also, the temperature on the bottom of the module is higher than the other areas owing to the lower thermal conductivity on the bottom interface (Akbarzadeh et al., 2020). Temperature maldistribution at the battery pack level, however, can be minimized with improved BTMS design.

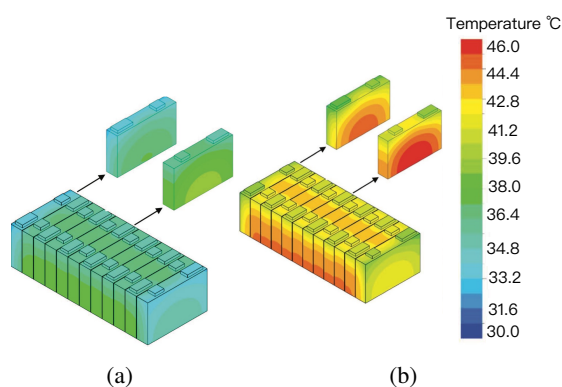

Figure 1: Temperature distribution on the module surface, (a) 1C discharge and (b) 2C discharge. (Akbarzadeh et al., 2020).

Individual Cell Level. Temperature distribution of a single cell is also uneven since the current density is higher in electrode regions, as illustrated in Fig. 2 (Jeon, 2014; Xu et al., 2015). However, the temperature distribution mainly depends on the cell shapes. The prismatic and pouch cells are expected to have higher temperature in the tabs regions, while the cylindrical cell is expected to have significantly higher temperature in the core region than at its surface (Inui et al., 2007; Tomaszewska et al., 2019). The simulation results of Wang et al. (Wang et al., 2015a) demonstrated that the prismatic cell's surface temperature difference could range from $\sim 10^{\circ}\text{C}$ (at 2.1C) to $\sim 20^{\circ}\text{C}$ (at 5C) during discharging, as illustrated in Fig. 3. While Fleckenstein et al.'s (Fleckenstein et al., 2011) study indicated that the surface temperature distribution for the cylindrical cell was still fairly even, but the core temperature was significantly higher than its surface, which was $\sim 20^{\circ}\text{C}$ difference at 6530 s with 70A pulse cycles, as illustrated in Fig. 4. Admittedly, the surface temperature distribution for any shape of cells cannot be perfectly even but enough to be neglected in low C-rate thermal modelling. Jeon (Jeon, 2014) built a transient thermo-electric model of Lithium-ion battery to predict the temperature distribution inside the cell. Fig. 5 illustrates the temperature distribution of a cylindrical Lithium-ion battery at 1C discharge and charge, respectively (Jeon, 2014). The temperature contours presented that the maximum temperature was found below the centre of the cell, and the minimum temperature was observed at the top cap. Nevertheless, the overall cell surface temperature difference was under 3°C and the main body (except for the cap region where there is no chemical reaction happening) surface temperature difference was under 1°C , which was insignificant. Likewise, Xu et al.'s (Xu et al., 2015) simulation results (see Fig. 6) indicated that

although a prismatic LiFePO_4 battery had higher temperature in tab region, the maximum temperature difference were only 0.3°C and 1°C at 1C and 2C discharge, respectively. Noticeably, temperatures at the positive tab area were normally higher than those near the negative tab due to the lower ohmic resistivity of the copper current collector on the anode side compared to aluminium on the cathode side (Xu et al., 2015).

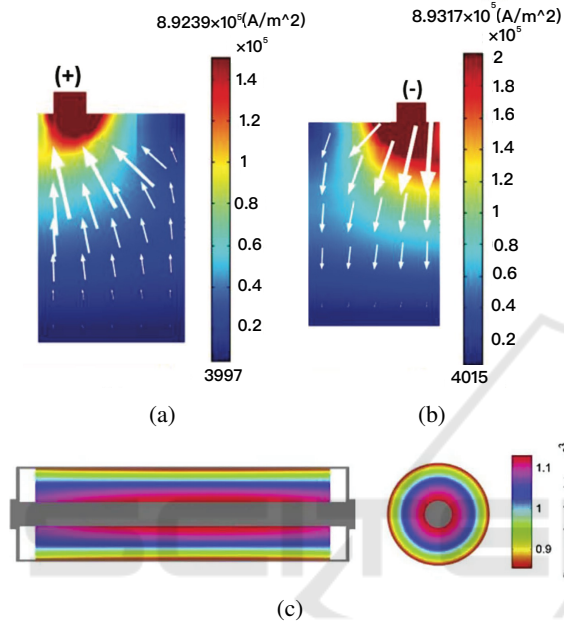

Figure 2: Current distribution in the prismatic cell (a) negative and (b) positive current collectors, and (c) cylindrical cell during 1C discharge process (Jeon, 2014; Xu et al., 2015).

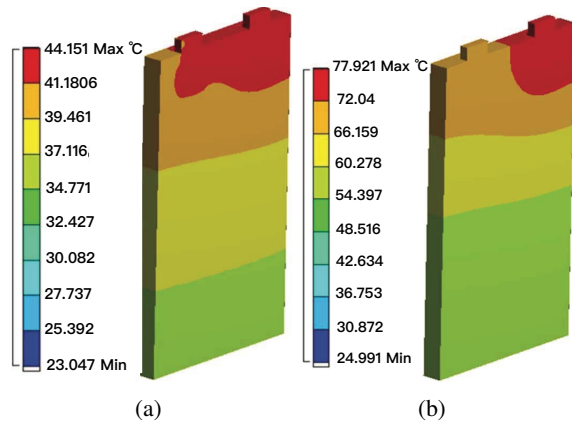

Figure 3: Maximum temperature distribution in a commercial LiFePO_4 battery (capacity: 7000 mAh, size: 118 mm \times 63 mm \times 13 mm), provided by ANSYS, for 15 and 35 A discharger (Wang et al., 2015a).

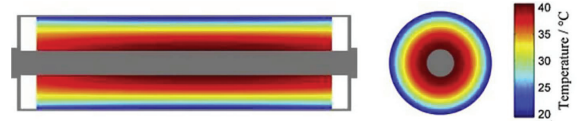

Figure 4: Simulated (a) temperature distribution, (b) current density distribution inside the LiFePO_4 cell directly at the end of the single cell cycle ($t = 6530 \text{ s}$).

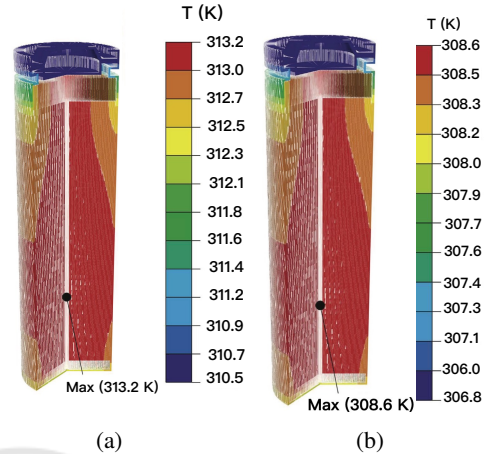

Figure 5: Temperature distribution of cylindrical Li-ion battery at the end of 1C (a) discharge and (b) charge (Jeon, 2014).

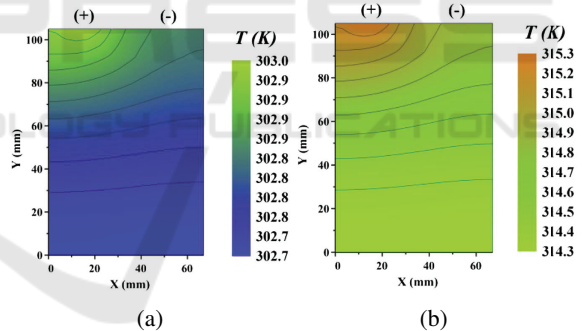

Figure 6: Temperature distribution of a prismatic LFP cell discharging at (a) 1C rate at 1020 s, and (b) 2C rate at 990 s (Xu et al., 2015).

In summary, the prismatic or pouch cell is expected to have a more significant non-uniformity in surface temperature distribution issue than the cylindrical cell under a high C-rate condition, while under a low C-rate condition, any shapes of cells surface temperature maldistribution can be reasonably neglected. This phenomenon may raise the attention to the specific BTMS designs corresponding to the different shapes of cells with various C-rate conditions to save computational cost and design complexity. To control the battery temperature from shape and C-rate aspects, there are various thermal mediums for different application fields, e.g., air for heat/cooling/ventilation, liquid for cooling/heating,

refrigerant for cooling, phase change material (PCM) for thermal storage, heat pipe for cooling, or a combination of these methods (Pesaran, 2001). To date, air, liquid and refrigerant-based BTMS are the most prevalent ones for the commercial EVs (Wu et al., 2019).

2.1 Air Cooling BTMS

The air-based system is simple, reliable, economical, and electrically safe because air is ubiquitous and has perfect dielectric property. Thus, no isolation preventions are required between coolant media and cells, which helps air-based BTMS flexibly adapt to any shape of commercial cells. Also, due to the absence of liquid coolant, battery-swapping systems can be significantly simplified. Air BTMSs utilise blowers (Fig. 7) or an air conditioning unit (Fig. 7) to actively adjust the battery temperature. It manages to acquire higher efficiency than the natural one but can potentially be a noise source. Besides, voluminous ducts and blowers increase the cost, volume, and weight of BTMS and introduce parasitic power consumption, which acts contrary to the air-based system merits (Basu et al., 2016). Current studies mainly focus on the optimisations of the cell layout, airflow channel, or combined with other cooling strategies to mitigate the air BTMS shortfalls (Basu et al., 2016; Jang and Rhi, 2010; Wang et al., 2015b).

Cell Layout. An appropriate cell arrangement inside the battery pack is essential for an efficient cooling system. Poor cell layout designs can inhibit heat dissipation, induce heat accumulation inside the battery pack during EVs operations, and cause safety hazards. Various studies have been conducted on the cell's channels. Yang et al. (Yang et al., 2015) numerically investigated the cooling performances under 2C discharging rate with aligned arrangement (Fig. 8) and staggered arrangement (Fig. 8) for cylindrical cells based on a commercial FE solver at different ambient temperatures (at 5°C, 15°C, 25°C). They simulated various battery configurations related to the cell's transverse gap (S_x) and longitudinal gap (S_y) and computationally derived that the aligned layout was the optimal configuration choice for their case regarding the least maximum temperature, temperature difference and total power consumption. Their results also agreed with Fan et al.'s work (Fan et al., 2019) that aligned arrangement had the best cooling performance, energy effectiveness and temperature uniformity. Additionally, Fan et al. proposed a new cross arrangement in their studies illustrated in Fig. 8, which had better cooling performance than the staggered one but still less performant than the aligned arrangement,

due to the cross structures for air cooling enhanced the local convective heat transfer, which exacerbated the temperature differences among the cells (Fan et al., 2019).

Airflow Channel. Channel design mainly focuses on the inlet/outlet size, air duct angle and airflow direction. Yang et al. (Yang et al., 2015) simulated different inlet width's influence on the cooling performance, temperature uniformity, cooling efficiency and determined that when inlet width equalled $0.5S_x$, the system achieved the optimal performance. Compared to the inlet width of $1.0S_x$, the maximum temperature difference among the cells reduced 0.5°C, and the power requirement decreased by 2.3% and cooling efficiency increased by 1.7%. Regarding the air duct angle optimisation, Xie et al. (Xie et al., 2017) adjusted the inlet and outlet air duct angles to modify the airflow inside the battery pack as illustrated in Fig. 9. They showed that the lowest system temperature and temperature difference are obtained where the inlet and outlet angle are both 2.5°. The maximum temperature and the temperature difference are decreased by 12.82% and 29.72%, respectively. As for the airflow direction research, various airflow path configurations have been proposed and can be mainly classified into three types: U-type, Z-type, and other novel types, see Fig. 10. U- and Z-type are the conventional configurations. The U-type battery pack, where the pack inlet and outlet are located at the same side, introduces cooling air from the lower duct, and cool air flows through the cooling channels between two adjacent battery cooling plates, and eventually, the hot air exhausts from the upper vent through the pack outlet (Solyali and Akinlabi, 2020). Contrarily, the Z-type battery pack, the inlet and the outlet are located on the opposite sides. The outlet for conventional configurations is fixed, Li et al. (Liu and Zhang, 2019) therefore proposed a novel J-type airflow configuration with two outlets controlled by valves to enhance the cooling flexibility. The least temperature rise and temperature differences are achieved in the J-type configuration that the maximum temperature difference was 3°C compared to 5°C for the conventional layouts (Liu and Zhang, 2019).

In general, air BTMS offers various advantages such as low cost, space compactness, leakage-free, and lightweight. Whereas, the main disadvantages of air-based BTMS are the low thermal conductivity and heat capacity which tremendously limited its cooling performance and can form a high-temperature gradient inside the battery pack. Also, this may impose constraints on the assembling location of the battery pack on EVs. Therefore, air cooling BTMS is adopted by a few EV manufacturers nowadays.

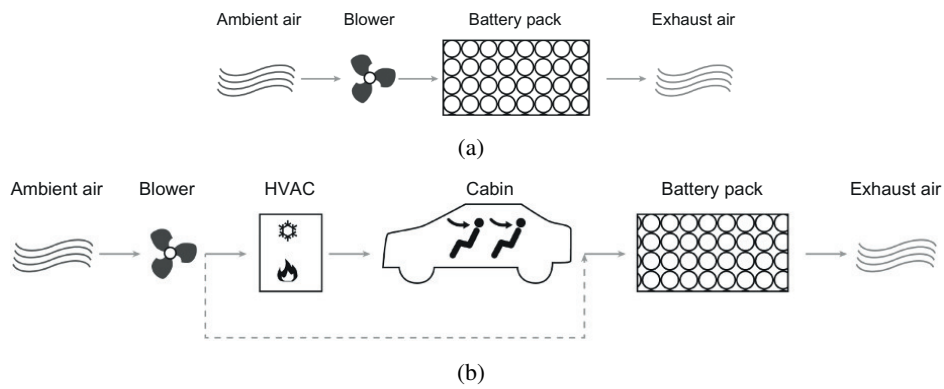

Figure 7: Schematic design of (a) an air-based battery cooling system using only ambient air, and (b) with preconditioned cabin air(Scrosati et al., 2015).

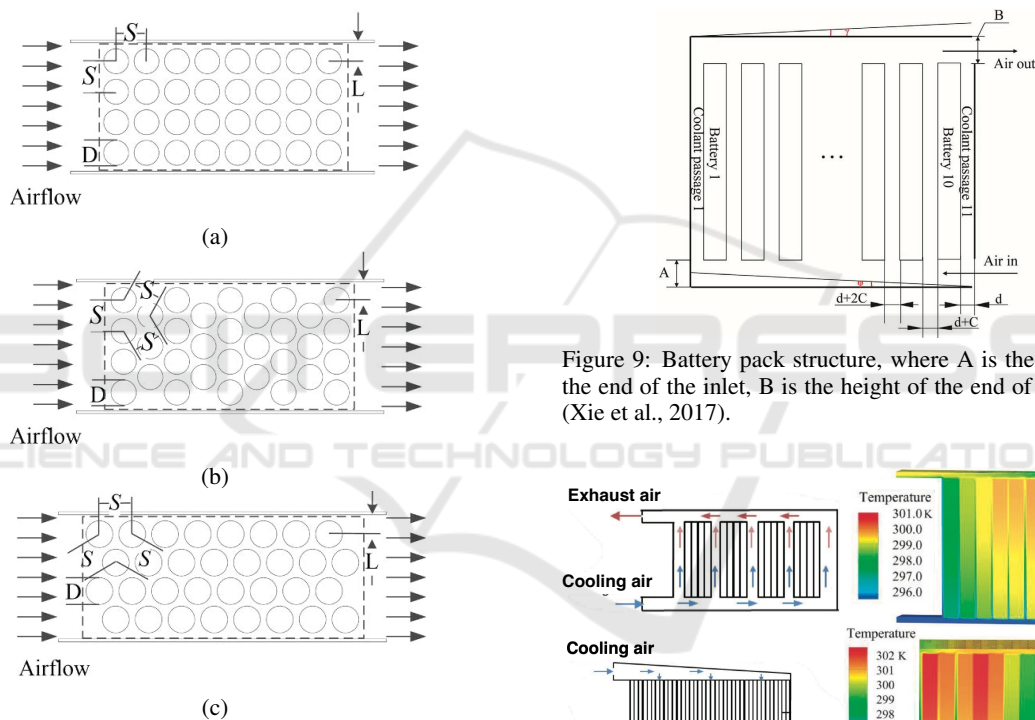

Figure 9: Battery pack structure, where A is the height of the end of the inlet, B is the height of the end of the outlet (Xie et al., 2017).

Figure 8: Schematics plan view of forced air convection system for cells arrayed in: (a) Aligned (b) Staggered (c) Cross (Fan et al., 2019).

2.2 Liquid Cooling BTMS

Liquid cooling is the most prevalent thermal management method on BTMS owing to its high cooling performance, increased maintainability, moderate power consumption, rapid thermal response, and suitability for both cooling and preheating conditions compared to those of the air-based BTMS (Zhang et al., 2017). Significant cooling performance and good controllability also qualify liquid-based BTMS for challenging state-of-the-art concepts such as fast charging or ex-

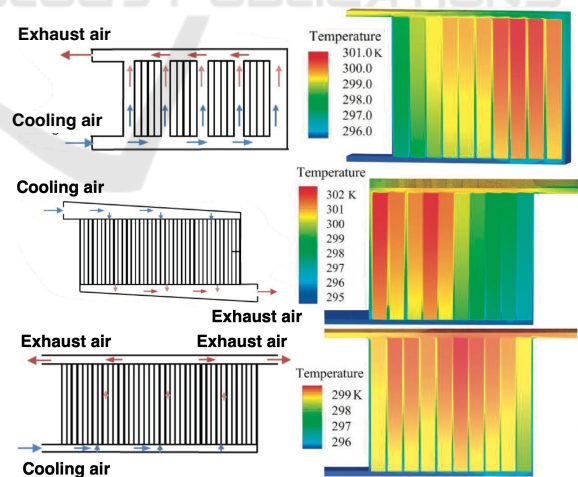

Figure 10: U-, Z-, and J-type BTMS and their temperature distributions (Liu and Zhang, 2019; Solyali and Akinlabi, 2020).

treme climate conditions operations (Scrosati et al., 2015). Consequently, the use of liquid cooling systems is a practical option for commercial BTMS applications and has already been extensively imple-

mented by automobile manufactures, including Tesla, BMW, General Motors, BYD (Scrosati et al., 2015; Wu et al., 2019; He et al., 2015; Thakur et al., 2020). In liquid cooling BTMS, cells and cooling medium are separated by the heat conducting materials. The generated heat is conducted from the battery into the cooling medium and removed via circulation. Thus, strict isolation between cells and coolant is crucial to cooling liquid since water, glycol, acetone, or refrigerants can be flammable, hazardous, or conductive and can cause devastating consequences such as fire and short circuit if leakage occurs (Wang et al., 2015b; Sundén, 2019). Thus, additional channel materials and electrical insulating coatings are necessary for liquid cooling BTMS. As a trade-off, the system's thermal resistance is elevated, and the contact resistance at the contacting interfaces between cells and conductors can inhibit the heat transfer and form local hotspots, which weakens the thermal performance of the pack accordingly (Basu et al., 2016; Thakur et al., 2020). The typical indirect liquid-based BTMS design for EVs tempts to a liquid and air cooling combination and enable to switch between each mode dynamically. Fig. 11 depict a schematic of a typical indirect liquid cooling system on EV where the air cooling is utilised under the normal operations and switching to refrigerating loop by a three-way valve in peak loads or high ambient temperatures circumstances to further cool down the liquid via a chiller (Scrosati et al., 2015). The chiller shown in Fig. 11 is a machine acting as a heat exchanger that coupled the coolant and refrigerant circuits together and allows the coolant to be further cooled down via the air-conditioning system on EV. This concept has been adopted by the Chevrolet Volt and Tesla vehicles (Scrosati et al., 2015). The liquid cooling BTMS can be classified into two types: cold plate and discrete tube, according to the approaches of passing the liquid through the channel.

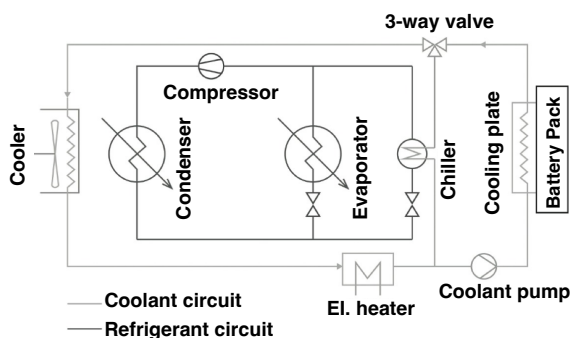

Figure 11: Dual cooling system comprising coolant and refrigerant circuit (Scrosati et al., 2015).

Cold Plate. The cooling plate is a flat shape metal plate made with internal tubes where a cooling liquid is flowing in serpentine or concentric channels, and the heat is dissipated by convection (Wu et al., 2019). The prismatic cell modules mostly adopt it due to its large contact area. The typical arrangements of cold plates include the sandwich form and the side form that the plates are inserted between the adjacent cells as the sandwich form or placed on the side/bottom of the module as the side form, as illustrated in Fig. 12 (Wu et al., 2019; Sundén, 2019). Cold plates present an economical solution for liquid cooling. Nevertheless, the parasitic mass should also be considered in the BTMS design.

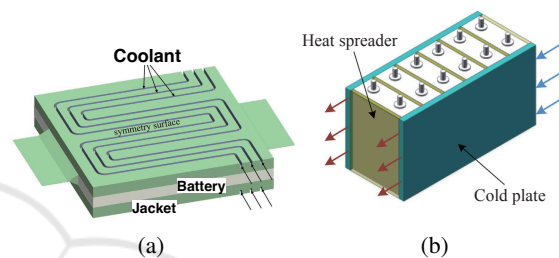

Figure 12: Schematics of the cold-plate based liquid cooling: (a) sandwich form (b) side form (Wu et al., 2019; Sundén, 2019).

The cold plate thermal performance has been extensively studied. Chen et al. (Chen et al., 2016) investigated the cooling performance of the sandwich form and the side form. The temperature difference of the sandwich form was the largest. The initial temperature difference reached the peak value with the increasing flow rate (approximately 7°C), and decreased afterwards. While the overall battery temperature was continuously decreasing with the increasing flow velocity. Chen et al. explained this was because of the long coolant channel and high thermal conductivity of the coolant and emphasised that the low mass flow rates in liquid cooling BTMS should be avoided. However, higher mass flow indicates higher power consumption. To balance the temperature difference and the power consumption, Zhang et al. (Zhang et al., 2017) proposed a cascade cooling method with variable inlet coolant temperatures that utilised the sandwich form with flat tubes assisted by the high thermal conductivity graphite to enhance the heat transfer, as illustrated in Fig. 13. In their cooling tests, the initial inlet coolant temperature was identical to the initial battery temperature and they gradually decreased the coolant temperature to cool down the battery. In this way, the least temperature difference (below 5°C) and power consumption were obtained. The total time to achieve a steady-state for the cascade

cooling was approximately 2 min longer than that of constant low-temperature coolant cooling, but the steady-state temperatures of the two different methods were basically consistent, which is regarded as an acceptable trade-off. Other than the side form, the bottom form is also adopted in some studies. Smith et al. (Smith et al., 2014) deployed a cold plate underneath the prismatic SANYO/PANASONIC PHEV-2, 25 Ah Lithium-ion cells, as illustrated in Fig. 14. In their study, Smith et al. treated the cells as a spatially uniform heat source. This is supported by the fact that the PHEV2 cell has a thick case leading to the lower conduction rate, and the temperature gradients are therefore not noticeable. However, it is still worth emphasising that the bottom cooling configuration may not be the most effective approach to dissipate the heat because, in real situations, the cell's local temperature around tabs is hotter than the bottom area due to the higher current density there (Sundén, 2019).

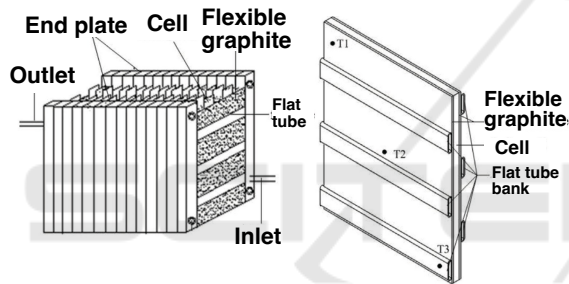

Figure 13: Designed battery pack and layout of the temperature measured points (Zhang et al., 2017).

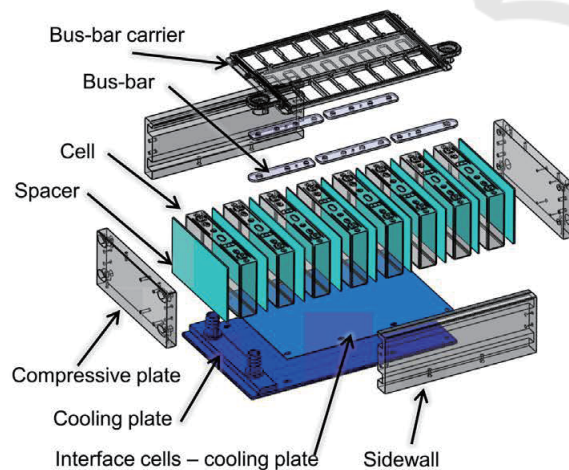

Figure 14: The layout of a battery module for SANYO prismatic cells. (Smith et al., 2014).

The previous methods are all based on prismatic cells. Basu et al. (Basu et al., 2016) designed a novel side form BTMS for cylindrical cells to investigate

the applicability of cold plate cooling for cylindrical cells. The Li-NCA/C 18650 cells were wrapped by the aluminium conduction elements and the heat from cells was conducted to the side aluminium channels carrying coolant liquid, as illustrated in Fig. 15. This structure also achieves leak-proof design because of separation of conduction element owing to the conduction elements separate the coolant and cells. In respect to the thermal performance, the cell's temperature could be maintained under 27°C (at 0.9C discharging rate), 28°C (at 1.8C discharging rate), 30°C (at 2.7C discharging rate) when the coolant inlet temperature was 23°C and flow velocity was 0.2 m/s. It revealed the excellent thermal performance of the proposed BTMS. Nevertheless, the thermal contact resistances at the conduction elements and cells interfaces were found to be the biggest hindrance to such BTMS configuration.

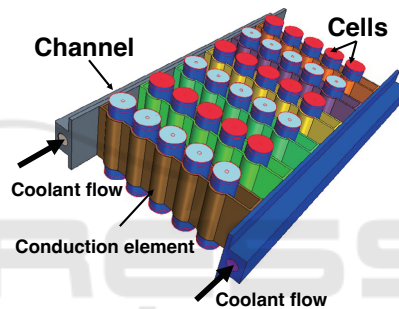

Figure 15: Geometry of the pack and the BTMS for the cylindrical cells based battery pack (Basu et al., 2016).

Discrete Tube. Discrete tubes are more applicable for cylindrical batteries due to their more flexible shape compared to the cold plate. A representative of discrete tube design is from Tesla, Inc where they adopted ribbon-shaped tubes with a wave profile on their Model S EV. Fig. 16 is a top-down view of a portion of a cooling tube with a wavy or scalloped profile (Tennessen et al., 2014). The illustrated shape of the cooling tube serves several purposes. First, it allows a larger area portion of each cell to be in thermal contact with the cooling tubes, thereby improving heat transfer. Second, it can achieve higher packing density of cylindrical cells battery pack by minimising the separation distance between adjacent cell rows. The overall discrete tube layout of the Tesla Model S is depicted in Fig. 17 (R. Maughan, 2021).

2.3 Refrigerant BTMS

A typical liquid cooling BTMS configuration is illustrated in Fig. 11, which contains two circulations - the coolant circulation and the refrigerant circulation

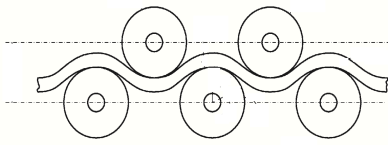

Figure 16: A top-down view of a portion of a cooling tube inserted between a plurality of cells (Tennessee et al., 2014).

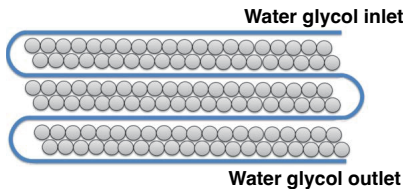

Figure 17: The schematic of Tesla Model S discrete tube cooling: tube is lagged with high heat transfer material and in close contact with side of cells (R. Maughan, 2021).

coupled by a chiller. Such design adds weight and complexity to the system. Thus, refrigerant BTMS has been proposed to overcome the disadvantage of the dual-circuit model. In refrigerant BTMS, the battery cooling circuit is directly integrated into the existing refrigerant cycle on EV. Therefore, the chiller and coolant exchange circuits can be entirely removed from the refrigerant system, which more weight and is more compact than the liquid-based BTMS (Scrosati et al., 2015). Also, the refrigerant has a lower electrical conductivity which reduces the possibility of a short circuit (Bhattacharjee et al., 2020). In practical applications, the configurations of refrigerant cooling BTMS resemble the cold plates liquid cooling in the way that heat sinks with embedded microchannels are installed on the top and bottom sides of the module (see Fig. 18) and absorb the heat from the modules. On the down side, the refrigerant BTMS cannot perform the heating of the battery, as may be needed in cold environments. This is because the refrigerant cannot be heated. Thus, refrigerant BTMS will not be able to preheat the battery in a cold environment (Lu et al., 2020) and common solution is applying an extra electric heater to the battery (Roth et al., 2004).

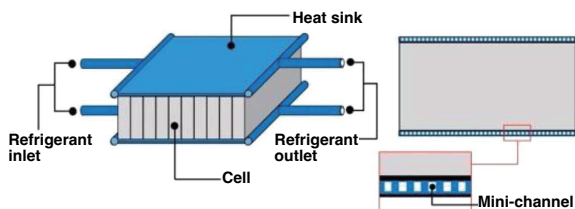

Figure 18: Diagram of refrigerant BTMS in practical applications form (Katoch and Eswaramoorthy, 2020; Lu et al., 2020).

The merit of the refrigerant cooling lies in that the refrigerant directly flows into the battery modules without a secondary heat transfer assisted by a chiller. Therefore, the refrigerant BTMS has a higher evaporation heat transfer coefficient, heat transfer effectiveness and simplicity compared to the liquid cooling BTMS. Hong et al. (Hong et al., 2020) experimentally investigated the thermal performance of direct two-phase refrigerant cooling. Due to its compact structure with mini channels, the weight of the cooling module was approximately 56% lower than that of the liquid cooling. They adopted R134a refrigerant as the cooling fluid compared to the ethylene glycol/water mixture (50:50) - a popular liquid coolant choice for EV manufacturers. Their results indicated that the maximum temperature of two-phase refrigerant cooling was 41.1°C under 2C fast charging conditions while that of the liquid cooling was 49.1°C, exceeding the cell's allowed operational temperature. During the regular charging and US06 drive cycle tests, although refrigerant and liquid cooling maintained the maximum temperature under 30°C, the overall maximum temperature of refrigerant cooling was consistently lower than that of liquid cooling during the whole process. As for the temperature difference, both cooling methods maintained the maximum temperature gradients below 5°C under 0.5C-2C charging rates conditions when liquid coolant temperature was 25°C, and the refrigerant vapour quality ($\chi = \frac{mass_{vapour}}{mass_{total}}$) was 0.85, respectively.

It should emphasise that R134a, as the most popular refrigerant, has been banned by the European Union for its usage on new cars after 2022. Due to R134a belongs to fluorinated greenhouse gas with high global warming potential (GWP), GWP=1410 (Schwarz et al., 2011). Hong et al. (Hong et al., 2020) proposed R1234yf (GWP= 4) as an alternative to R134a, but R1234yf is highly flammable. The future developments point toward making the liquid carbon dioxide - R744 (GWP=1, non-ozone depleting, non-toxic, non-flammable) the standard (Hoffmann, 2017).

3 BTMS APPLICATIONS ON EVs

The growth of EVs has soared over the last five years (IEA, 2021). The representative newer manufacturers include fast-growing companies e.g., Tesla, NIO, and the established automakers e.g., BMW, Nissan, GM, Renault There were about 7.2 million electric cars on the world's roads by 2019, among which the HEV(hybrid EV) and PHEV(plug-in hybrid EV) dominated in the early 2010, while BEV (battery EV)

started to take over the market after 2015 (IEA, 2021). According to The Global EV Outlook Report (IEA, 2021), BEV is expected to reach an average driving range of 350-400 km corresponding to battery sizes of 70-80 kWh by 2030, which offers similar ranges to an average fuel car (Wallbox, 2021). Therefore, EV manufacturers are pursuing for higher specific energy and specific power batteries to complete the full transition from PHEV/HEV to BEV and be more competitive against the fuel vehicles. In 2019, Chevrolet halted production of PHEV - Chevrolet Volt series and replaced with a new BEV series - Chevrolet Bolt (Jordan Fromholz, 2021). In June 2021, Model S, as Tesla's flagship originally launched in 2012, and equipped with a 100 kWh battery powertrain and the maximum driving range reached 637 km under WLTP test (Electric Vehicle Database, 2021; Mock et al., 2014). In January of the same year, NIO announced their first saloon - ET7, which equipped with an even larger 150 kWh solid-state battery and estimated driving range reached 1000 km under NEDC test (Mock et al., 2014; NIO, 2021). Due to the increased battery capacity and battery generated heat in driving surges, more efficient and powerful BTMS are required to secure EVs safety and performance. Table 1 summaries the main commercial EVs on the market to date and introduced their BTMSs, specifications and performance. It indicates that due to the increased battery capacity, the driving range of newer BEVs has become similar to fossil fuel vehicles. Meanwhile, the mainstream BTMS methods for EVs are still limited to air, liquid, and refrigerant based BTMSs, where liquid BTMS is the optimum choice for most EV manufacturers to date.

Air BTMS. Due to the simplicity of air cooling BTMS, forced convection air cooling has been presented in commercial EVs at the earliest stage. The earliest hybrid EVs (HEVs), such as Honda Insight and Toyota Prius (Fig. 19), are the early examples adopting the air cooling approach and proved the feasibility of air cooling BTMS (Zolot et al., 2001; Zolot et al., 2002; Scrosati et al., 2015). More recently, a representative BEV - Renault Zoe 2019 adopted an air conditioning unit system to blow cool air over the battery (Géraldine Dao, 2019).

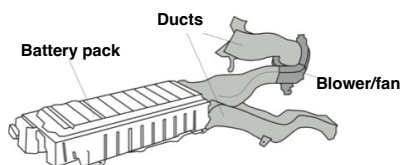

Figure 19: Toyota Prius Battery Pack including air ducts (Roth et al., 2004).

Liquid BTMS. As the most prevalent cooling method, liquid BTMS has been adopted by various automobile manufactures. Tesla's BTMS implements liquid glycol as a coolant distributed throughout the battery pack to transfer heat to the refrigeration cycle and utilises electric resistance heating in cold weather. GM adopts prismatic cells instead named Ultium batteries that flat cell pouches can stack on top of each other to save more space, illustrated in Fig.20 and cooled with aluminium cooling plates with embedded mini channels filled with liquid glycol (R. Maughan, 2021; George Bower, 2015; GM, 2020a). Such modular design offers a significant flexible energy combinations availability that can range from 50 kWh to over 200 kWh. Thus, engineers can customize various battery capacities for different EV models. Additionally, the mini-channel cooling approach can minimize the installation limitations compared to air cooling BTMS, which can translate to more miles on a single charge with less volume (GM, 2020a; GM, 2020b).

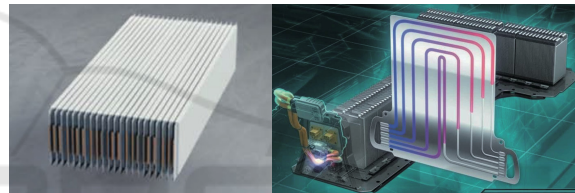

Figure 20: GM's new automotive battery packs consist of flat stackable Ultium cells with an aluminium cooling plate sandwiched between them (George Bower, 2015; GM, 2020a).

Refrigerant BTMS. It has been adopted in some EV models. BMW is the representative manufacture in favour of the refrigerant cooling method. BMW i3, as a lightweight EV, adopted a 42.2kWh battery, and driving range reached 246 km (Boretti, 2020). BMW i3 contains much less fluid compared to Tesla Model 3 since it adopts the refrigerants from the air conditioning system and only requires a small up-sizing of the air conditioning compressor to compensate for increased refrigerant demand (Munro, 2020). Thus, the weight of the cooling system only composes about 3% of the total battery weight (Schoewel and Hochgeiger, 2014). Regarding the thermal performance, the BMW i3 utilises a bottom cooling plate in its battery, elucidated in Fig. 21, which have only module-level contact to the coolant system. Therefore, temperature control performance can be less efficient than the Tesla Models, whereas the assembly and maintenance complexity has been significantly decreased (Munro, 2020; Schoewel and Hochgeiger, 2014).

Table 1: BTMS Strategies of Commercial Vehicles.

Year	Model	Type	BTMS	Capacity (kWh)	Battery Range (km)	Reference
2015	BMW i8	PHEV	Refrigerant	7.1-11.6	37	(Loveday, 2014)
2019	Renault Zoe	BEV	Forced Air	52	394	(Delobel et al., 2017; Géraldine Dao, 2019)
2019	Chevrolet Volt	PHEV	Cold Plate	18.4	85	(Loveday, 2020; GM, 2011)
2019	Kia Niro	BEV	Liquid	64	385	(Halvorson, 2019; Kane, 2019; Nisewanger, 2019)
2019	MINI SE	BEV	Liquid	32.6	225 -233	(Boeriu, 2020; Mini, 2021; Moloughney, 2020)
2020	Porsche Taycan	BEV	Liquid	79-93	408-484	(Auto Express, 2021)
2020	Hyundai Kona	BEV	Cold Plate	64	482	(Nisewanger, 2018; Hyundai, 2011)
2020	Hyundai IONIQ	BEV	Fan	38	310	(Hyundai, 2021)
2020	Volkswagen ID.3	BEV	Cold Plate	45-77	349-540	(Volkswagen, 2020)
2021	BMW i3	BEV	Refrigerant	37.9	292-305	(BMW, 2021; Munro, 2020)
2021	Tesla Model S	BEV	Discrete Tube	100	637-652	(Electric Vehicle Database, 2021; Tesla, 2021b)
2021	Tesla Model 3	BEV	Discrete Tube	54 - 82	447-579	(Tesla, 2021a)



Figure 21: BMW i3 bottom refrigerant cooling plate layout (Munro, 2020).

4 CONCLUSIONS

Nowadays, the use of Lithium-ion batteries in EVs tends to have higher energy density, power and more compact design, which requires more advanced BTMSs to enhance the prospects of safety, reliability and performance. This paper extensively reviews and classifies the current commercial BTMS on EVs according to its cooling medium. Air cooling, as the earliest BTMS on EVs, has the advantages of low weight, low cost and easy maintenance, but low cooling performance is the main bottleneck limiting its utilisation on the current EVs. The common trend in the past years has been to move from air BTMS to liquid BTMS to gain a more powerful cooling ability and increase the vehicle range accordingly. Liquid cooling BTMS is the most prevalent cooling method to EV manufacturers to date and also expected to dominant the EV market in the future. Whereas, the leakage, increment of parasitic mass, and higher design complexity and price are the main disadvantages of liquid BTMS. The refrigerant BTMS therefore becomes

an option to some EV manufactures as it has lower design complexity, weight, and cost, but the cooling performance is less efficient than the liquid BTMS and needs an extra heating system to heat up batteries. Currently, it is a popular solution to the low cost EVs. For the future BTMS design, the light weight, low cooling power consumption, and higher thermal conductivity BTMS integrating with multiple cooling methods will be a possible solution to the current facing limitations. Moreover, advanced but currently with low technology readiness levels BTMSs such as heat pipe, phase change materials, and thermoelectric can also potentially be the future solutions to EVs, but this is beyond the scope of this work.

REFERENCES

- Akbarzadeh, M., Kalogiannis, T., Jaguemont, J., He, J., Jin, L., Berecibar, M., and Van Mierlo, J. (2020). Thermal modeling of a high-energy prismatic lithium-ion battery cell and module based on a new thermal characterization methodology. *Journal of Energy Storage*, 32:101707.
- Auto Express (2021). Porsche taycan review - range, charging and running costs. <https://www.autoexpress.co.uk/porsche/taycan/range>.
- Basu, S., Hariharan, K. S., Kolake, S. M., Song, T., Sohn, D. K., and Yeo, T. (2016). Coupled electrochemical thermal modelling of a novel li-ion battery pack thermal management system. *Applied Energy*, 181:1–13.
- Bhattacharjee, A., Mohanty, R. K., and Ghosh, A. (2020). Design of an optimized thermal management system for li-ion batteries under different discharging conditions. *Energies*, 13(21).

- BMW (2021). Technical data of the bmw i3. <https://www.bmw.co.uk/en/all-models/bmw-i/i3/2020/technical-data.BMW--i3-120Ah.html>.
- Boeriu (2020). Mini cooper se – technical details and specifications. <https://www.bmwblog.com/2020/01/18/mini-cooper-se-technical-details-and-specifications/>.
- Boretti, A. (2020). On-board electric vehicles electricity production by high-efficiency internal combustion engines. *Przeglad Elektrotechniczny*, 96.
- Chen, D., Jiang, J., Kim, G. H., Yang, C., and Pesaran, A. (2016). Comparison of different cooling methods for lithium ion battery cells. *Applied Thermal Engineering*, 94.
- Delobel, B., Gordon, I. J., and Leveau, L. (2017). Zoe battery durability, field experience and future vision. *Renault Battery Development Department*.
- Electric Vehicle Database (2021). Model s long range. <https://ev-database.uk/car/1404/Tesla-Model-S-Long-Range>.
- Fan, Y., Bao, Y., Ling, C., Chu, Y., Tan, X., and Yang, S. (2019). Experimental study on the thermal management performance of air cooling for high energy density cylindrical lithium-ion batteries. *Applied Thermal Engineering*.
- Fleckenstein, M., Bohlen, O., Roscher, M. A., and Bäker, B. (2011). Current density and state of charge inhomogeneities in li-ion battery cells with lifepo4 as cathode material due to temperature gradients. *Journal of Power Sources*, 196(10):4769–4778.
- George Bower (2015). Tesla or gm: Who has the best battery thermal management? <https://insideevs.com/photo/3957897/tesla-or-gm-who-has-the-best-battery-thermal-management/>.
- GM (2011). Cooling fins help keep chevrolet volt battery at ideal temperature. https://media.gm.com/media/us/en/gm/home.detail.html/content/Pages/news/us/en/2011/Feb/0214_battery.html.
- GM (2020a). Flat, stackable ev batteries are the winning formula. <https://www.gm.com/our-stories/technology/flat-battery-stackable-ev.html>.
- GM (2020b). Gm reveals all-new flexible platform and ultium batteries. <https://www.gm.com/our-stories/commitment/ev-battery-modular-technology.html>.
- Géraldine Dao (2019). Pre-conditioning and your electric car's range. <https://easyelectriclife.groupe.renault.com/en/day-to-day/range/pre-conditioning-and-your-electric-cars-range/>.
- Halvorson (2019). 2019 kia niro ev: first drive of 239-mile electric crossover. https://www.greencarreports.com/news/1121294_2019-kia-niro-ev-first-drive-of-239-mile-electric-crossover.
- He, W., Zhang, G., Zhang, X., Ji, J., Li, G., and Zhao, X. (2015). Recent development and application of thermoelectric generator and cooler. *Applied Energy*, 143:1–25.
- Hoffmann, G. (2017). Refrigerants for mobile air conditioning. *ATZ worldwide*, 119(1):16–21.
- Hong, S. H., Jang, D. S., Park, S., Yun, S., and Kim, Y. (2020). Thermal performance of direct two-phase refrigerant cooling for lithium-ion batteries in electric vehicles. *Applied Thermal Engineering*, 173:115213.
- Hyundai (2011). New kona electric. <https://www.hyundai.co.uk/new-cars/kona-electric>.
- Hyundai (2021). Ioniq electric, pure electric, pure satisfaction. <https://www.hyundai.co.uk/new-cars/ioniq-electric>.
- IEA (2021). Global electric car stock, 2010-2019, iea, paris. <https://www.iea.org/data-and-statistics/charts/global-electric-car-stock-2010-2019>.
- Inui, Y., Kobayashi, Y., Watanabe, Y., Watase, Y., and Kitamura, Y. (2007). Simulation of temperature distribution in cylindrical and prismatic lithium ion secondary batteries. *Energy Conversion and Management*, 48(7):2103–2109.
- Jang, J.-C. and Rhi, S.-H. (2010). Battery thermal management system of future electric vehicles with loop thermosyphon.
- Jeon, D. H. (2014). Numerical modeling of lithium ion battery for predicting thermal behavior in a cylindrical cell. *Current Applied Physics*, 14(2):196–205.
- Jordan Fromholz (2021). The chevy volt vs. bolt: The differences. The Chevy Volt vs. Bolt: The Differences.
- Kane (2019). Everything we know about the 2019 kia niro ev (e-niro). <https://insideevs.com/news/345556/2019-kia-niro-ev-e-niro/>.
- Katoch, S. S. and Eswaramoorthy, M. (2020). A detailed review on electric vehicles battery thermal management system. In *IOP Conference Series: Materials Science and Engineering*, volume 912, page 042005. IOP Publishing.
- Liu, Y. and Zhang, J. (2019). Design a j-type air-based battery thermal management system through surrogate-based optimization. *Applied Energy*, 252.
- Loveday (2014). First bmw i8 deliveries scheduled for june - final performance / fuel consumption figures released. <https://insideevs.com/news/320920/first-bmw-i8-deliveries-scheduled-for-june-final-performance-fuel-consumption-figures-released/>.
- Loveday (2020). 2016-2019 chevy volt review from honest owner's perspective. <https://insideevs.com/reviews/408403/2016-2019-chevrolet-volt-review/>.
- Lu, M., Zhang, X., Ji, J., Xu, X., and Zhang, Y. (2020). Research progress on power battery cooling technology for electric vehicles. *Journal of Energy Storage*, 27(Feb.):101155.1–101155.16.
- Ma, S., Jiang, M., Tao, P., Song, C., Wu, J., Wang, J., Deng, T., and Shang, W. (2018). Temperature effect and thermal impact in lithium-ion batteries: A review. *Progress in Natural Science: Materials International*, 28(6):653–666.
- Mini (2021). New mini electric. https://www.mini.co.uk/en_GB/home/range/mini-electric.html.
- Mock, P., Kühlwein, J., Tietge, U., Franco, V., Bandivadekar, A., and German, J. (2014). The wltp: How a new test procedure for cars will affect fuel consumption values in the eu. *International council on clean transportation*, 9(3547).
- Moloughney (2020). 2020 mini cooper se: Big fun, short on range, but easy on the wal-

- let. <https://insideevs.com/reviews/395747/2020-mini-cooper-se-first-drive-report/>.
- Motors, T., Berdichevsky, G., Kelty, K., Straubel, J., and Toomre, E. (2007). The tesla roadster battery system. *tesla motors inc*.
- Munro (2020). Tearing down tesla segment 4: Battery cooling system comparison on tesla model 3 vs. bmw i3. <https://leandesign.com/tearing-down-tesla-segment-4-battery-cooling-system-comparison-on-tesla-model-3-vs-bmw-i3/>.
- NIO (2021). Nio et7-ready for tomorrow-et7. <https://www.nio.com/et7>.
- Nisewanger (2018). Exclusive: details on hyundai's new battery thermal management design. <https://electricrevs.com/2018/12/20/exclusive-details-on-hyundais-new-battery-thermal-management-design/>.
- Nisewanger (2019). Lg sues sk, alleges stolen trade secrets used to make kia niro and future vw batteries. <https://electricrevs.com/2019/04/30/lg-sues-sk-alleges-stolen-trade-secrets-used-to-make-kia-niro-and-future-vw-batteries/>.
- Pesaran, A. A. (2001). Battery thermal management in ev and hev's: issues and solutions. *Battery Man*, 43(5):34–49.
- R. Maughan (2021). What is the best electric vehicle battery cooling system? <https://avidtp.com/what-is-the-best-cooling-system-for-electric-vehicle-battery-packs/>.
- Reddy, T. B. (2011). *Linden's handbook of batteries*. McGraw-Hill Education.
- Roth, E. P., Crafts, C. C., Doughty, D. H., and McBreen, J. (2004). Advanced technology development program for lithium-ion batteries: thermal abuse performance of 18650 li-ion cells. *Sandia Nat. Lab., Albuquerque, NM, USA, Rep. SAND2004-0584*.
- Schoewel, F. and Hochgeiger, E. (2014). The high-voltage batteries of the bmw i3 and bmw i8. In *Proceedings of the Advanced Automotive Battery Conference (AABC), Atlanta, GA, USA*, volume 45.
- Schwarz, W., Gschrey, B., Leisewitz, A., Herold, A., Gores, S., Papst, I., Usinger, J., Oppelt, D., Croiset, I., Pedersen, P. H., et al. (2011). Preparatory study for a review of regulation (ec) no 842/2006 on certain fluorinated greenhouse gases. *Final report, Sept*.
- Scrosati, B., Garche, J., and Tillmetz, W. (2015). *Advances in battery technologies for electric vehicles*. Woodhead Publishing.
- Slowik, P., Hall, D., Lutsey, N., Nicholas, M., and Wappelhorst, S. (2019). Funding the transition to all zero-emission vehicles. *White Paper*.
- Smith, J., Hinterberger, M., Hable, P., and Koehler, J. (2014). Simulative method for determining the optimal operating conditions for a cooling plate for lithium-ion battery cell modules. *Journal of Power Sources*, 267:784–792.
- Solyali, D. and Akinlabi, A. (2020). Configuration, design, and optimization of air-cooled battery thermal management system for electric vehicles: A review. *Renewable and Sustainable Energy Reviews*, 125(109815).
- Sundén, B. (2019). *Hydrogen, Batteries and Fuel Cells*. Academic Press.
- Tennessen, P. T., Weintraub, J. C., and Hermann, W. A. (2014). Extruded and ribbed thermal interface for use with a battery cooling system. US Patent 8,758,924.
- Tesla (2021a). Model 3. https://www.tesla.com/en_gb/model3?redirect=no.
- Tesla (2021b). Model s plain. <https://ev-database.uk/car/1405/Tesla-Model-S-Plaid>.
- Thakur, A. K., Prabakaran, R., Elkadeem, M., Sharshir, S. W., Arıcı, M., Wang, C., Zhao, W., Hwang, J.-Y., and Saidur, R. (2020). A state of art review and future viewpoint on advance cooling techniques for lithium-ion battery system of electric vehicles. *Journal of Energy Storage*, 32:101771.
- Tomaszewska, A., Chu, Z., Feng, X., O'Kane, S., Liu, X., Chen, J., Ji, C., Endler, E., Li, R., Liu, L., et al. (2019). Lithium-ion battery fast charging: A review. *ETransportation*, 1:100011.
- Volkswagen (2020). Battery and charging options. <https://www.volkswagen-newsroom.com/en/the-new-id3-6240/battery-and-charging-options-6247>.
- Wallbox (2021). How do evs compare to gas cars? <https://blog.wallbox.com/how-do-evs-compare-to-gas-cars/>.
- Wang, C., Lin, T., Huang, J., and Rao, Z. (2015a). Temperature response of a high power lithium-ion battery subjected to high current discharge. *Materials Research Innovations*, 19(sup2):S2–156.
- Wang, Q., Jiang, B., Xue, Q. F., Sun, H. L., Li, B., Zou, H. M., and Yan, Y. Y. (2015b). Experimental investigation on ev battery cooling and heating by heat pipes. *Applied Thermal Engineering*, pages 54–60.
- Wu, W., Wang, S., Wu, W., Chen, K., Hong, S., and Lai, Y. (2019). A critical review of battery thermal performance and liquid based battery thermal management. *Energy conversion and management*, 182:262–281.
- Xie, J., Ge, Z., Zang, M., and Wang, S. (2017). Structural optimization of lithium-ion battery pack with forced air cooling system. *Applied Thermal Engineering*, 126.
- Xu, M., Zhang, Z., Wang, X., Jia, L., and Yang, L. (2015). A pseudo three-dimensional electrochemical-thermal model of a prismatic lifepo4 battery during discharge process. *Energy*, 80:303–317.
- Yang, N., Zhang, X., Li, G., and Hua, D. (2015). Assessment of the forced air-cooling performance for cylindrical lithium-ion battery packs: A comparative analysis between aligned and staggered cell arrangements. *Applied Thermal Engineering*, 80:55–65.
- Zhang, T., Gao, Q., Wang, G., Gu, Y., Wang, Y., Bao, W., and Zhang, D. (2017). Investigation on the promotion of temperature uniformity for the designed battery pack with liquid flow in cooling process. *Applied Thermal Engineering*, 116(Complete):655–662.
- Zolot, M., Pesaran, A. A., and Mihalic, M. (2002). Thermal evaluation of toyota prius battery pack. Technical report, SAE Technical paper.
- Zolot, M. D., Kelly, K., Keyser, M., Mihalic, M., Pesaran, A., and Hieronymus, A. (2001). Thermal evaluation of the honda insight battery pack. Technical report, National Renewable Energy Lab., Golden, CO (US).